

The CROWSNEST

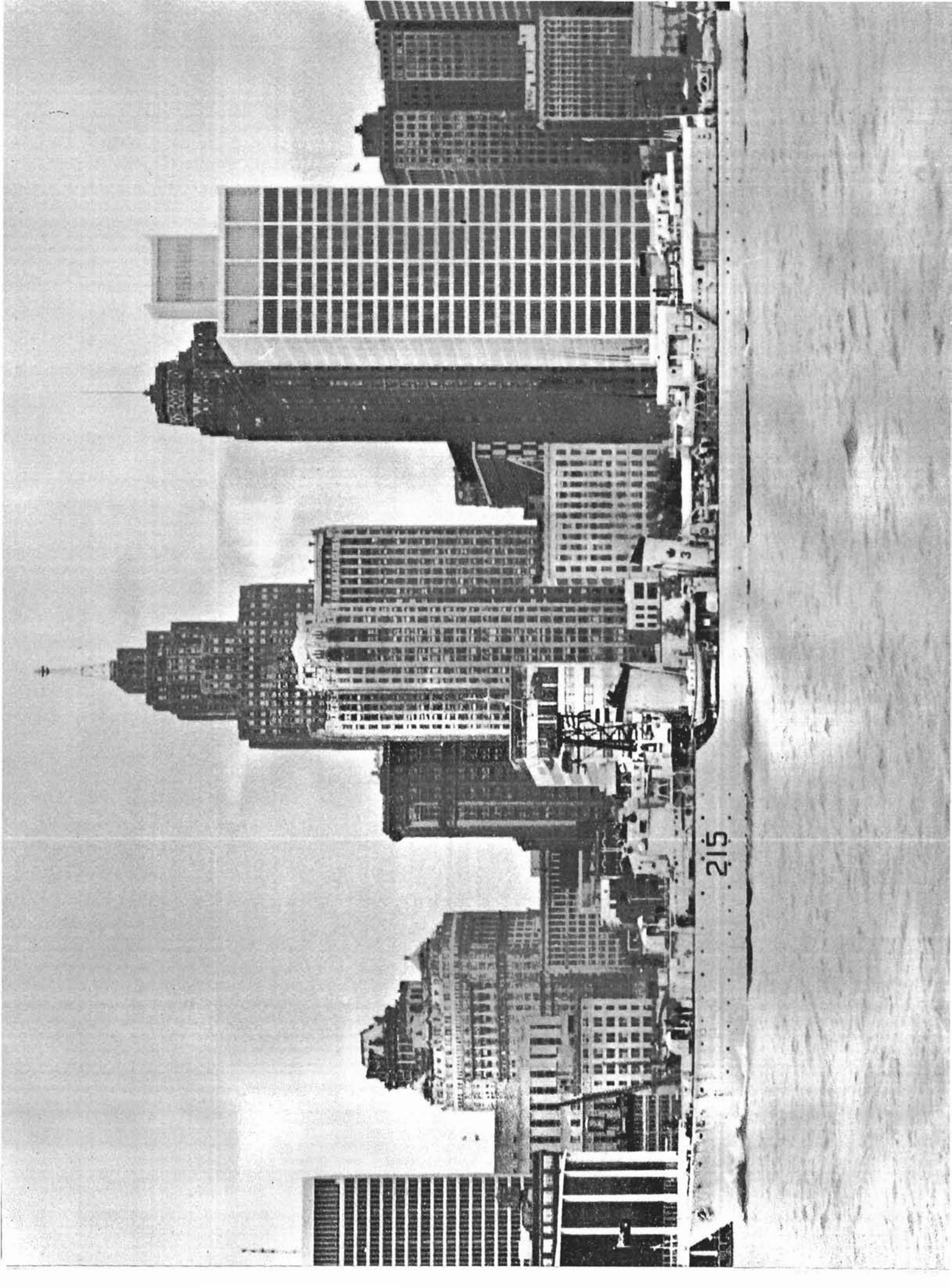

Club



215

The CROWSNEST

Vol. 15 No. 7

THE ROYAL CANADIAN NAVY'S MAGAZINE

JULY 1963

CONTENTS

	Page
<i>RCN News Review</i>	2
<i>The New Hydrofoil</i>	5
<i>Sourdough</i>	7
<i>Officers and Men</i>	9
<i>Dental Therapist</i>	12
<i>The Last Days of Sail (Part Three)</i>	13
<i>Visit to Mazatlan</i>	16
<i>Home from the Sea</i>	18
<i>The End of HMS Seraph</i>	19
<i>Here and There in the RCN</i>	21
<i>Books for the Sailor</i>	23
<i>Trade Group Not Bar to Promotion</i>	25
<i>Letters to the Editor</i>	26
<i>Retirements</i>	27
<i>Naval Lore Corner No. 118</i>	<i>Inside Back Cover</i>

The Cover—Fickle winds again robbed the *Oriole* of victory in the Swiftsure classic this year, but there were merry breezes to help the West Coast training yacht along when she made a cruise to Seattle in June. The picture was taken by Ldg. Sea. Edward Kochanuk. (E-72698)

LADY OF THE MONTH

Here is a companion piece to the picture on the inside of the front cover of the May issue, which showed HMCS *Columbia* with Manhattan's towers in the background.

This time the ship is HMCS *Haida* and the towering buildings forming the backdrop are those of the U.S. automobile metropolis, Detroit. The veteran Tribal class destroyer escort was steaming down the Detroit River after having paid a visit to the naval veterans' reunion at Sarnia when she was photographed from the Canadian side of the river. (Photo courtesy *The Windsor Star*)

Negative numbers of RCN photographs reproduced in *The Crowsnest* are included with the caption for the benefit of persons wishing to obtain prints of the photos.

This they may do by sending an order to the Naval Secretary, Naval Headquarters, Ottawa, attention Directorate of Naval Photography, quoting the negative number of the photograph, giving the size and finish required, and enclosing a money order for the full amount, payable to the Receiver General of Canada.

Sizes, finish and the National Defence standardized prices, follow:

4 x 5 (or smaller) glossy finish only ..	\$.10
6½ x 8½ glossy finish only40
8 x 10 glossy or matte finish50
11 x 14 matte finish only	1.00
16 x 20 " " "	3.00
20 x 24 " " "	4.00
30 x 40 " " "	8.00

SUBSCRIPTION RATE

The Crowsnest may be subscribed for at the rate of \$2 a year; outside of North America, \$3. Orders, accompanied by cheque or money order payable to the Receiver General of Canada, should be sent to:

THE QUEEN'S PRINTER,
Department of Public Printing
and Stationery,
OTTAWA, Ontario

Communications, other than those relating to subscriptions, should be addressed to:

EDITOR,
The Crowsnest,
Naval Headquarters,
OTTAWA, Ontario.



RCN NEWS REVIEW

The guard at the present, preparatory to firing the feu de joie during the sunset ceremony at Cornwallis. The ceremony was again a feature of Dominion Day celebrations in Ottawa this year. (DB-18028)

Senior Posts Exchanged

Rear-Admiral Kenneth L. Dyer, Flag Officer Atlantic Coast and Maritime Commander Atlantic, with headquarters at Halifax, and Rear-Admiral Jeffrey V. Brock, Vice-Chief of the Naval Staff at Naval Headquarters, Ottawa, exchanged appointments in July.

Rear-Admiral Dyer had held the East Coast appointments since August 1960. He became a member of the Naval Board on taking up his new appointment.

Rear-Admiral Brock had been Vice-Chief of the Naval Staff since June 1961.

First Aid Trophy To Navy Firemen

The Naval Fire Service first aid team from HMC Dockyard, Esquimalt, has won the Totem trophy emblematic of the B.C. provincial first aid championship. A message of congratulation was addressed to the team on June 25 by Rear-Admiral W. M. Landymore, Flag Officer Pacific Coast.

Cadets Cruise To Southern U.S.

Forty preparatory year cadets from the College Militaire Royal de St. Jean embarked in two frigates of the Ninth

Escort Squadron in late June for a month-long training cruise to southern U.S. ports.

The *Swansea* and *Cape de la Madeleine* are visiting the ports of St. John's, Nfld.; Charleston, South Carolina; Miami, Florida, and Bermuda, returning to Halifax August 2.

The cadets, all in their first year at CMR, are receiving their first taste of shipboard navy life.

C-in-C Home Fleet Visits Canada

Admiral Sir Charles Madden, Commander-in-Chief of NATO's Eastern Atlantic Area and Commander-in-Chief of the British Home Fleet, visited Canada July 2-11.

He was in Ottawa July 2-4 for discussions with senior officials of the Department of National Defence and then went to Kingston, July 5.

On July 6, Admiral Madden embarked in HMS *Tenby*, a Whitby class frigate, at the northern end of the Welland Canal for passage down the St. Lawrence Seaway and river, to arrive at Quebec City July 9.

Admiral Madden was to fly from Quebec City to Halifax on July 10 and leave Halifax the following day by air for Britain.

Dental Cadets Look at Navy

A group of 17 cadets of the Royal Canadian Dental Corps toured RCN Atlantic Command facilities in June.

The tour has included such naval shore establishments as *Shearwater* and *Stadacona* and the diving tender *Granby*.

Wrens Founded 21 Years Ago

Canada's wrens attain their majority this year, and the occasion will be celebrated at a reunion in Winnipeg.

The first class members of the Women's Royal Canadian Naval Service completed its training in August 1942. Ex-wrens from coast to coast and from the United States will attend the national reunion planned for August 23, 24 and 25.

The program of the three-day celebration will be centered on HMCS *Chippawa*, the Winnipeg naval division, and United College, where visitors from out of town will be accommodated.

Wrens wishing further information should get in touch with Mrs. Nina Davis, 80 Beaver Bend, St. James 12, Manitoba.

New Commandant For Royal Roads

Captain William P. Hayes has been appointed as commandant, Canadian Services College, Royal Roads, effective July 17.

Captain Hayes has been serving at Naval Headquarters since September 1961, first with the Joint Missile Defence Staff and later with the Directorate of Strategic Studies.

He succeeds Group Captain Alan F. Avant who has held the appointment since July 1960. Group Captain Avant will take up a new appointment as commanding officer of 1 Wing at Marville, France, July 30.

Captain Hayes, who was born in Swift Current, Sask., entered the Royal Canadian Navy in August 1939 after graduating from the Royal Military College Kingston.

He served in ships of the Royal Navy until July 1942 and during this period was with the force which launched the naval air attack on the Italian naval base at Taranto. He witnessed the sinking of an Italian destroyer by his ship, the cruiser HMS *York*, and took part in the evacuation of Crete. He survived the sinking of the *York* in Suda Bay in May 1941.

In October 1942, he was appointed to the *Iroquois* and served on convoy routes to Russia and on patrols in the Bay of Biscay and the English Channel. In the postwar years, Captain Hayes served in the destroyer *Nootka*, and *Magnificent* and held various shore appointments.

He took command of the destroyer *Cayuga* in February 1953 and, after a tour of duty in the Korean War theatre, was appointed officer of *Naden*, in January 1955.

Captain Hayes was appointed for courses with the United States Navy in July, 1958. He commissioned the *Columbia* in November 1959.

He was promoted to his present rank and appointed Commander Fifth Canadian Escort Squadron on April 26, 1961.

RN Submarine Visits East Coast

The British submarine *Odin* was in Halifax in mid-May for a two-day informal visit. Commanded by Lt.-Cdr. Simon Burrage, the *Odin* has a complement of 71 officers and men.

Auxiliaries Draw Praise

Units of the RCN's Blue Ensign fleet were officially praised recently for widely differing tasks at sea.



PO Rendell Guinchard (left) and AB Richard Chipman display certificates awarded for "exemplary operational performance", for making a confirmed initial detection of a U.S. nuclear submarine during a joint RCN-USN exercise off the eastern seaboard. PO Guinchard, a weaponman underwater, who usually serves on board HMCS *Gatineau*, was on loan to HMCS *Terra Nova*, in which AB Chipman is a sonarman. The certificates are signed by Rear-Admiral Robert E. Riera, Commander of Carrier Division 14 of the U.S. Navy. The submarine detected was the USS *Nautilus*. (HS-71053-159)

The minelayer *Bluethroat* and ocean tug *St. Charles* were singled out for high praise at Newport, Rhode Island, following a recent NATO exercise. The convoy commodore said the civilian-manned, Halifax-based ships did an outstanding job in the convoy, especially during a period of heavy weather in late April on the North Atlantic.

More recently the *St. Charles* received a "well done" from Rear-Admiral K. L. Dyer, Flag Officer Atlantic Coast, on the excellent seamanship displayed by her master, Captain Walter May, of Dartmouth, in a heavy swell while transferring a patient off Halifax from the USNS *General Maurice Rose* on the night of May 13.

The transport was en route to New York from overseas when it became necessary to convey a U.S. serviceman's child to hospital.

Helicopter Aids Injured Boy

An injured 13-year-old boy was rescued by two Royal Canadian Navy helicopter pilots on April 15 from Finlayson Mountain, 10 miles west of Victoria.

The pilots inched their helicopter along a face of the mountain at tree-top level to pick up the boy, Ken Peach, of Victoria, who suffered head and back injuries when he fell 30 feet on the mountain.

Volunteer rescuers, firemen from nearby Langford, carried the boy down to the mountain's 100-foot level and strapped him into a stretcher for the helicopter to pick up. He is in good condition in Royal Jubilee Hospital in Victoria.

Sub-Lt. I. A. Powick, pilot of the craft, and PO Ronald Greenbury took the helicopter into a narrow space with only 10 feet of clearance on either side between the mountain face and trees, to make the rescue. The helicopter got out by flying backwards along its course.

On the East Coast, a helicopter was despatched from *Shearwater* on May 4 at the request of RCMP to search for a seven-year-old boy lost in woods near Sheet Harbour, N.S. The boy found his way out of the woods while the search was in progress.

Artemis Joins Division Briefly

The British submarine *Artemis* joined the Sixth Submarine Division at Halifax for the first three weeks of June.

She exercised with ships and aircraft of the RCN until leaving the Halifax station to meet other commitments of the Royal Navy.

Six DDEs Go On Atlantic Exercises

Six RCN destroyer escorts left Halifax June 10 for exercises in the Atlantic to be followed by a six-week training cruise to Britain and Europe.

They were the *Gatineau* (Cdr. J. W. Roberts), the *St. Croix* (Cdr. D. M. MacLennan), the *Chaudiere* (Cdr. R. H. Falls), the *Kootenay* (Cdr. D. H. Ryan), the *Columbia* (Cdr. A. E. Fox) and the *Terra Nova* (Cdr. J. B. Young).

The ships are units of the Fifth Canadian Escort Squadron, commanded by Captain C. P. Nixon, who was embarked in the *Gatineau*.

After fuelling at Plymouth, England, June 23, the ships were to visit Kiel, West Germany, from June 26 to July 1; Copenhagen, Denmark, from July 2 to

July 9, and be based at Londonderry, Northern Ireland, from July 13 to 28. The squadron will return to Halifax on August 5.

Families Taken On Short Cruise

May 18 was "family day" for four destroyer escorts of the Pacific Command's Second Canadian Escort Squadron.

Wives and families of personnel serving in the *Fraser*, *Skeena*, *Margaree* and *Saguenay* were invited on board the ships for a cruise in local waters.

During the five-and-a-half-hour cruise the families witnessed gun-firing practice, the transfer of personnel from one ship to another by jackstay, and the firing of the ships' anti-submarine mortars.

The combination business-and-pleasure cruise permitted further training

for ships' companies, and at the same time gave wives and children of the sailors a first-hand look at a fleet operation.

It was the first time that four ships of the command have joined in such a dependents' day cruise.

Anniversary of Battle Observed

The 150th anniversary of the engagement between HMS *Shannon* and the USS *Chesapeake* was commemorated as part of the regular 11 a.m. service on Sunday, June 2, at St. Paul's Church in Halifax.

A United States Navy task force visiting port at that time landed 100 officers and men to attend the service. The Sixth Submarine Division of the Royal Navy provided British naval representation and the RCN was represented also. The RN-RCN contingents totalled 100.

Canon H. St. C. Hilchey, rector of St. Paul's, conducted the service, assisted by Lt.-Cdr. Edwin J. Nerthling, USN, senior Protestant chaplain of the visiting U.S. warships. Captain J. M. West, commanding officer of the aircraft carrier *Essex*, read the first lesson (Micah 4: 1-5) and Cdr. Kenneth Vause, RN, Commander Sixth Submarine Division, the second (Romans 13:1-9).

Senior naval officers attending included Rear-Admiral E. E. Christensen, USN, Commander Carrier Division 18, and Rear-Admiral Kenneth L. Dyer, RCN, Flag Officer Atlantic Coast.

Commemoration of this particular engagement was considered appropriate since it has a prominent place in the history of Halifax and of St. Paul's. The presence of British and American forces in port on the anniversary strengthened these historical links.

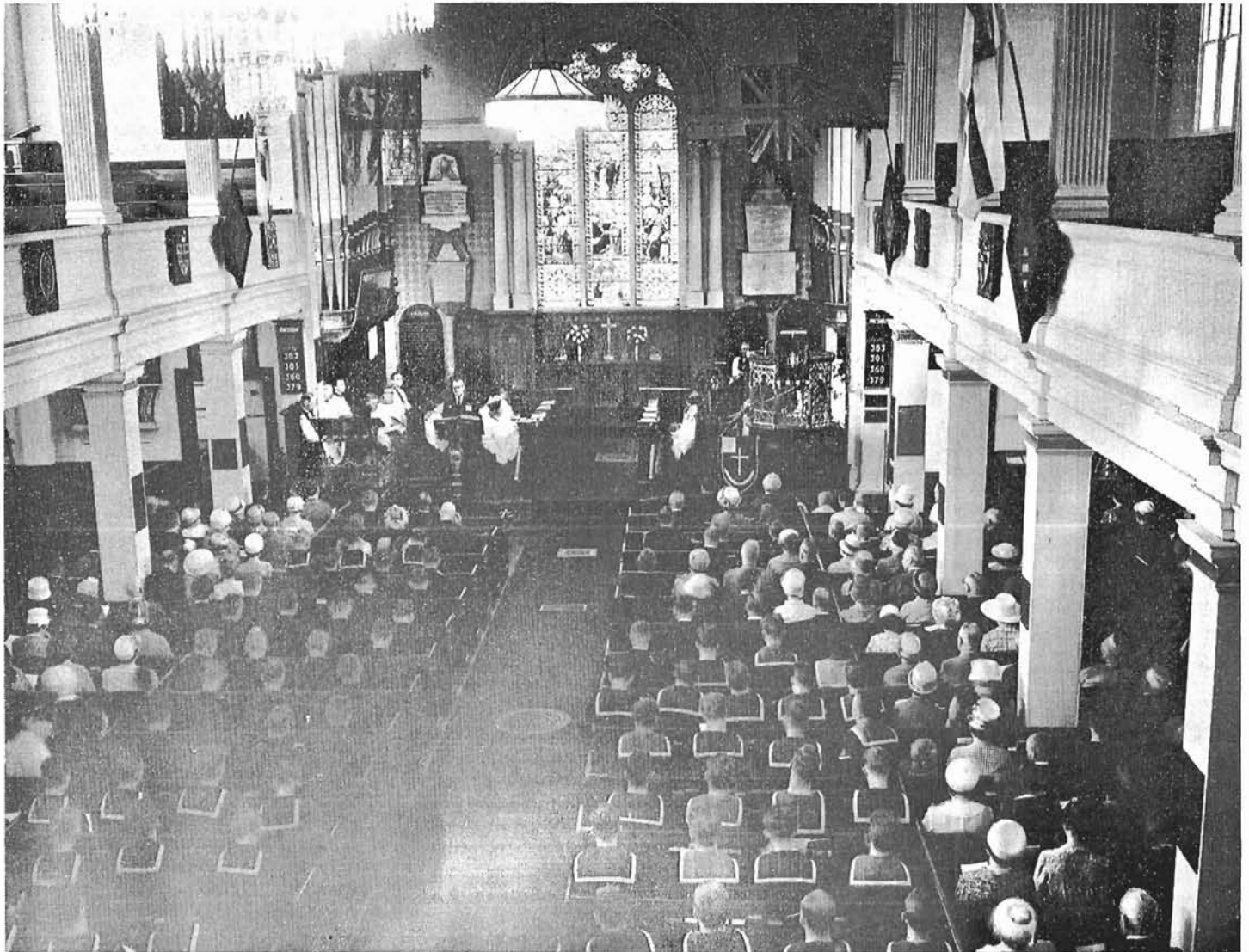

Captain J. M. West, USN, commanding the aircraft carrier *Essex*, reads the first lesson during a service of commemoration in St. Paul's Church, Halifax on June 2 of the HMS *Shannon*-USS *Chesapeake* naval engagement on June 1 a century and a half earlier. The *Essex* landed 100 officers and men for the service and an equal number were provided from HMCS *Stadacona* and the Royal Navy's Sixth Submarine Division. (HS-72160)

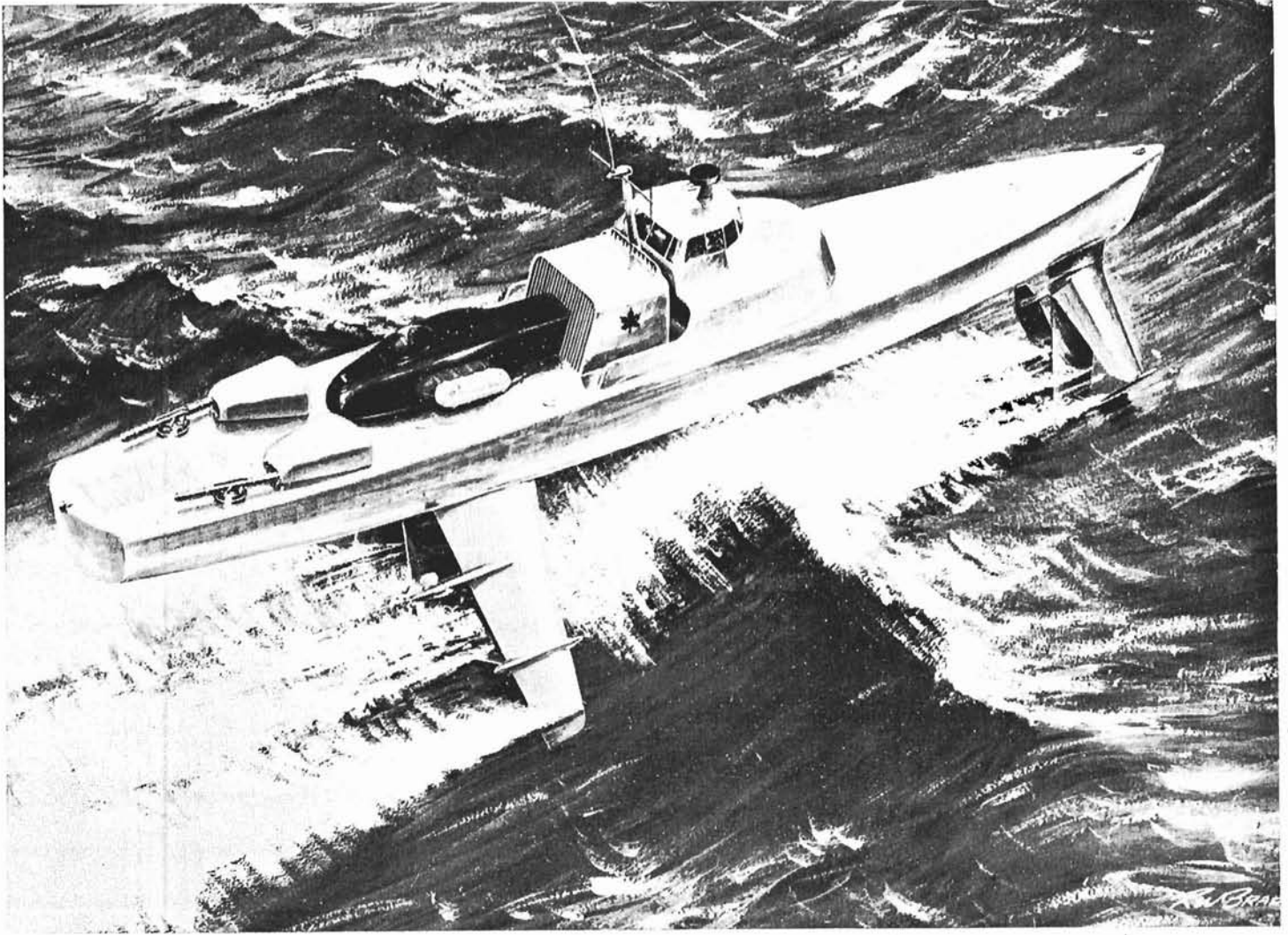

An artist's sketch of the prototype hydrofoil craft which will be designed and built for the Royal Canadian Navy. The 150-foot craft is expected to be capable of speeds in excess of 50 knots. The project is the result of extensive research carried out by scientists of the Defence Research Board, with the object of producing a relatively small, high-speed, low-cost vehicle capable of efficient anti-submarine operations on the high seas. The de Havilland Aircraft of Canada Ltd., Toronto, is the prime contractor, with other Canadian industries contributing (CN-6571)

The New Hydrofoil

APPROVAL has been given to proceed with plans for the design and construction of a prototype hydrofoil ship for the Royal Canadian Navy, it was announced on May 17 by Hon. Paul Hellyer, Minister of National Defence. This is a further key step in a research and development program, in a new and unproven field, with the aim of extending and increasing the anti-submarine capability of the RCN.

A contract has been awarded to The de Havilland Aircraft of Canada Limited, Downsview, Ont., to complete the details of design and construct the prototype. Marine Industries Ltd., of

Sorel, Quebec, has been selected as the sub contractor responsible for the hull assembly and fitting out operations.

It is emphasized that the project is of an experimental nature, and whether the hydrofoil craft will be successful in the anti-submarine role is still to be determined. However, design studies and model tests have been promising, and Canada's development of the prototype is in areas not covered by other allied countries conducting hydrofoil experiments.

The Canadian concept has certain unique features which, it is felt, merit development to the prototype stage so

that the hydrofoil ship can be given necessary evaluation tests in rough sea conditions.

The hydrofoil craft basically consists of a hull mounted on struts fitted with lateral blades, or "foils". On reaching a certain speed, the hull is raised above the sea surface by the lift generated by the foil system.

In this state, the craft can work up to high speeds and maintain a relatively even plane.

The Canadian-designed hydrofoil uses a fixed surface-piercing foil system. Variation in lift is achieved by changes in the immersed area of the foil and

by changes in craft trim as the bow foil reacts to changes in wave height. No moving parts are required. Significant attributes of this fixed foil system are reliability, ruggedness and ease of maintenance.

Studies into the adaptation of hydrofoil craft to naval usage were begun at Halifax in 1951 by the Naval Research Establishment of the Defence Research Board. First experiments were carried out by NRE with a 45-foot boat acquired from a private owner and fitted with a "ladder" foil unit as continuation of the work started by Alexander Graham Bell and F. W. (Casey) Baldwin on the Bras d'Or Lakes in Nova Scotia in 1919.

In 1957 a larger craft, built in Britain for the Defence Research Board, was brought to Halifax on board HMCS *Bonaventure* and was made the subject of further NRE experiments. In addition, the NRE scientists used a small, barge-like experimental craft to test various types of foils.

These studies culminated in a detailed proposal by NRE for a full-scale all-weather ocean-going hydrofoil craft and in 1960 the Department of Defence Production placed a contract with The de Havilland Aircraft of Canada for a design study based on this proposal. In so far as could be determined through the use of scale models and scientific and engineering studies, the de Havilland project established that such a hydrofoil craft was feasible. On this basis, approval has been given to proceed with detailed design and construction of a prototype.

Hydrofoil craft are in commercial service in several parts of the world but there is none in existence having characteristics needed for a vehicle capable of performing in the wide range of weather and sea condition encountered on the high seas.

Design and construction of the prototype is expected to take about three years. On completion, the vehicle will be put through extensive trials to determine its seakeeping qualities. Next step in the program will be the testing of equipment and weapons under operational conditions.

The vehicle will be approximately 150 feet in length, will displace about 180 tons and will be capable of speeds in excess of 50 knots. The craft will have two propulsion systems: a marine diesel engine, for use when operating in the displacement conditions and a gas turbine for use when foil-borne.

The hydrofoil craft offers promise of performing a variety of roles, commercial as well as military.



The White Ensign of the Royal Canadian Navy will be flown no more by HMCS *Lauzon*, Halifax-based frigate paid off for disposal on May 24. The *Lauzon* served during the latter part of the Second World War. In two postwar commissions she steamed more than a quarter-million miles on the North Atlantic. (HS-48204)

Lauzon Retires From Service

The frigate *Lauzon* was paid off for disposal on May 24 in a ceremony in the Dockyard at Halifax.

The ship's company was addressed by Lt.-Cdr. C. E. M. Leighton, commanding officer. CPO B. G. Penwarn presented a cheque for \$2,500 to Captain W. M. Kidd, president of the Fleet Club Advisory Council, towards the establishment of permanent new quarters for the club. The money was accumulated through canteen profits and non-public funds in the ship.

CPO Penwarn also presented a TV set for use in the existing club, which opened May 11 for the benefit of the leading seamen and below of the fleet in the former chief and petty officers' lounge at *Stadacona*.

AB R. C. Downey, a sonarman with almost four years' service in the *Lauzon*, presented another TV set to the Canadian Forces Hospital. It was accepted by the matron, Lt.-Cdr. (NS) Grace Walker.

Following prayers by the Eastern Command chaplains, Chaplain (P) Bruce Peglar and Chaplain (RC) James MacLean, the *Stadacona* band played two verses of the Naval Hymn. The Sunset Hymn and National Anthem followed, at which time the *Lauzon's* White Ensign, commissioning pennant and Canadian jack were lowered for the last time. The ship's company marched off to "Heart of Oak".

The frigate will be disposed of through Crown Assets for scrap, after all items useful to the fleet have been removed.

SOURDOUGH

F EED IT to your cat. Feed it to your dog and, if there's some left over, give it to your horse. If unexpected guests drop in, drag it out again and feed it to them.

Twist it, tramp on it, throw all but a pinch of it away, tuck it into your shirt pocket and bring it out again next day for another meal all around.

What is this magical food, you ask? Why, that wonderful leftover of leftovers—sourdough. The staple of the northland kept many a prospector from starvation in Gold Rush days.

Sourdough still is used extensively today, by outdoorsmen everywhere and more particularly in the northland. For instance, Mrs. Ruth Allman of Juneau, Alaska, brought out her 40-year-old leftover for a group of officers and men of the Fourth Canadian Escort Squadron frigates *New Glasgow* and *Ste. Therese*.

The frigates called in at the Alaska state capital in April while on a northern patrol.

Mrs. Allman kept the luncheon party entranced for more than two hours with tales of old Alaska. She is well qualified to speak on the subject as she and her husband, the late Jack Allman, prospected throughout the north in the 1920s and '30s.

THE FACTS ABOUT SOURDOUGH

Could be that sourdough flap-jacks will be standard items on the menu of HMCS Yukon, providing the cooks find out what to do with that "sourdough starter," presented to the ship on behalf of Yukon Territory. If they don't know what the starter is for, they can ask the people on board HMCS Ste. Therese, who made a visit to Juneau, Alaska, in April and thereby became authorities in this staple item of the Trail of '98.

Lt. A. G. Gibson, information officer with HMCS Malahat, Victoria naval division, was in the Ste. Therese for training and saw the sourdough starter in action when he was a guest in an Alaskan home. He tells all about it in the accompanying article.

Mrs. Allman's main claim to fame, however, is the fact that she's the niece of the famous Alaska district court judge, author and explorer, the late James Wickersham.

All of the famed judge's books, Eskimo and Indian artifacts and even his 70-year-old two-storey frame house up on Chicken Ridge in Juneau have been kept in fine condition by Mrs. Allman.

She now makes tourists welcome year around with her unique lunches and stories of the Panhandle. Mrs. Allman need only turn around in her chair to reach for a book, a diary or photostats to help explain some phase of the Wickersham saga.

But it's that small wad of dough that Mrs. Allman keeps in an earthenware pot that interests the Chechako (or newcomer to Alaska) the most.

Mrs. Allman has used this fist-sized bit of sourdough for more than 40 years, storing it in the refrigerator in its dormant state. She could double its size in less than a minute by just adding flour and water and have three tubfuls of the doughy mass by next morning.

The menu for the sailors was typical of what she prepares for all visitors. She baked a batch of waffles, served them with small sausages, butter and an amazing assortment of jams, jellies, honeys and syrups, all made from rose petals and rose hips—the other main staple of food of the Klondike days.

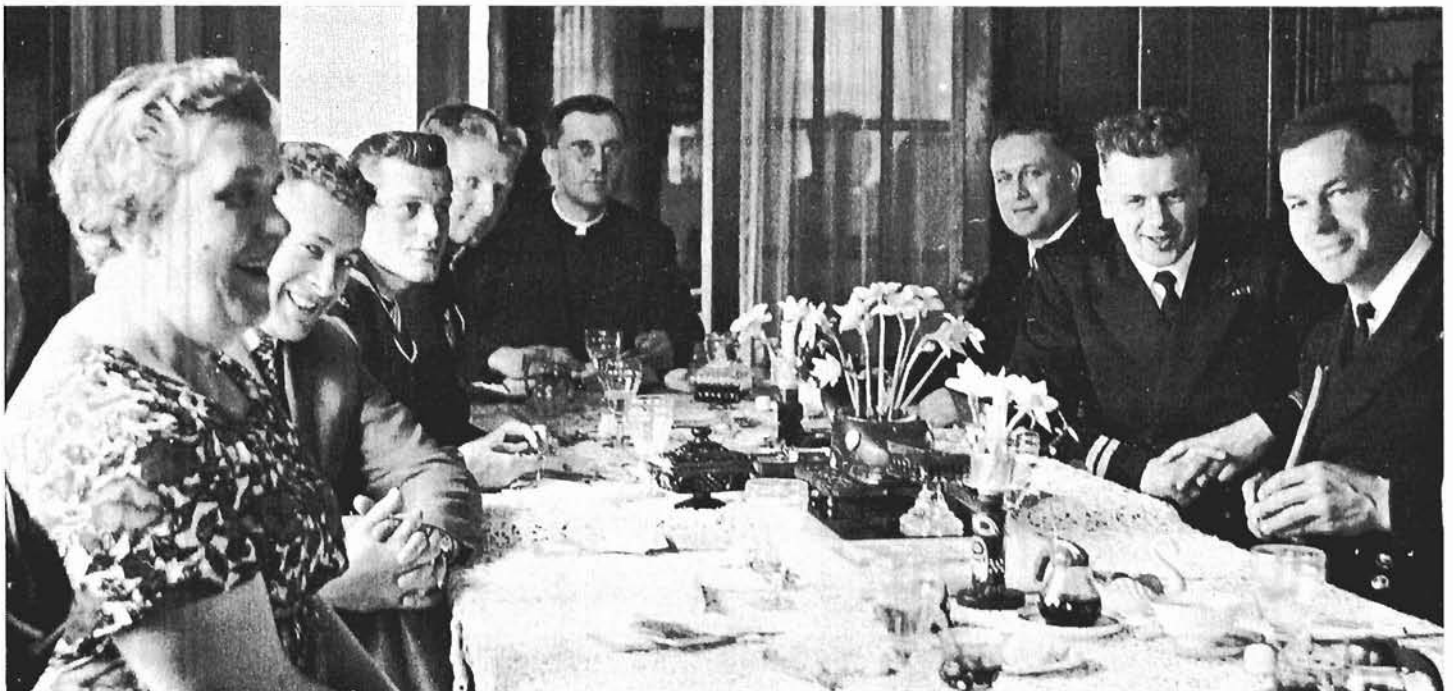

RCN guests surround the well appointed table of Mrs. Ruth Allman, in Juneau, Alaska. From left to right are Mrs. Allman, Lt. B. J. Burgess, of HMCS Ste. Therese; AB B. D. Brett and Ldg. Sea. S. A. Martin, of HMCS New Glasgow; Chaplain (P) E. P. Timmons, Ste. Therese; Lt. W. G. Austin, Lt. R. R. Godden and Lt. G. E. Pumple, all of New Glasgow. Lt. A. G. Gibson took the picture.

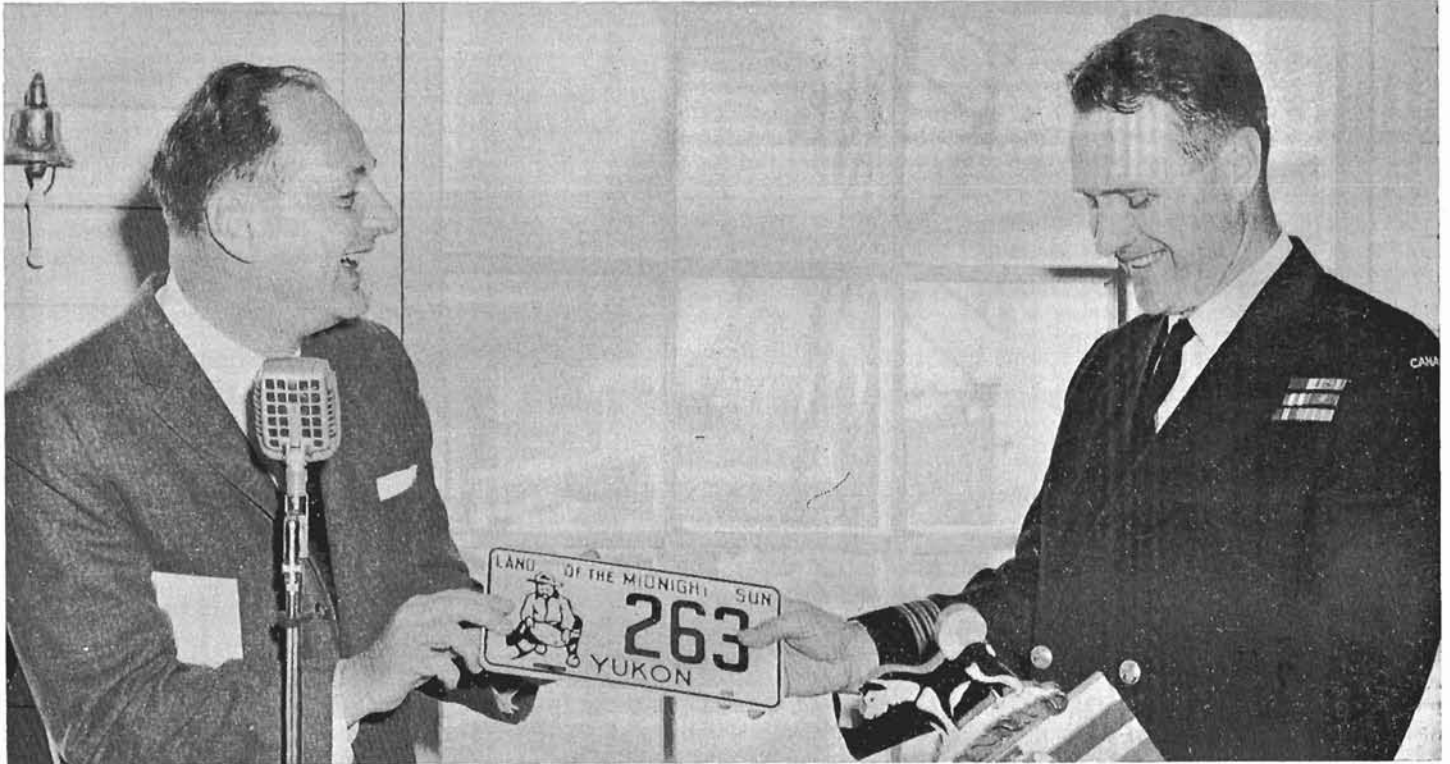

Three gifts were bestowed by Yukon Territory on HMCS Yukon when she was commissioned in North Vancouver on May 25. Roy Minter, of Vancouver, officially representing the Yukon commissioner and territory, gave the ship's captain, Cdr. R. W. J. Cocks, Yukon licence plates for the Yukon's jeep, bearing the ship's hull number, a badge of the territory and some sourdough pancake starter (yeast) said to be descended from the days of the Klondike gold rush of '98. Mr. Minter is with the White Pass and Yukon Route office in Vancouver. (E-72484)

Dessert was her own special brand of baked Alaska—more waffles, topped off with ice cream, strawberries and a flaming cube of sugar. Coffee and conversation rounded out the enjoyable repast.

But waffles are only one baking by-product of sourdough. You can make doughnuts, cakes, breads—in fact almost anything in the baking line from it.

The natural question about now must be: Of what is sourdough made? It's merely some mashed potato that's been fermented, then stored in a cool temperature. In other words, a source of yeast.

All the old prospector had to worry about packing around with him was his pinch of sourdough (perhaps tucked in an old tobacco can) and a sack of flour. The wild Alaska rose was his main source of vitamins to ward off the dreaded scurvy.

In fact, down there, in the small print on today's vitamin bottle, it may be acknowledged that rose hips are its base.

The opening remarks about the animals eating sourdough are no exaggeration either. It was often sourdough or nothing for a dog-team, packhorse or mule when the weather closed in out on the trail. Mrs. Allman had a cat that refused to eat much else.

The sailors from *Ste. Therese* and *New Glasgow* tucked right in. One

young seaman passed the remark that he thought every mess should have its own sourdough.

Now if somebody will just pass the flour and water, and turn up the griddle, it's hands to supper. But before you dig in, there is a grace that accompanies a meal involving sourdough. It has been adopted by the International Sourdoughs' Reunion and is to be said by Sourdoughs the world over wherever they gather. The word "Sourdough" is the nickname of the men of the Gold Rush.

The grace, written by another famous figure of the North, the "Sky Pilot of the Yukon", the late Rev. George C. F. Pringle, is as follows:

*Bless thou this food, O Lord, we pray,
And lovingly guide us on Life's strange way,
When Earth's trail ends and no longer we roam,
Take us safely across to our Heavenly Home.*

Perhaps you're interested in baking with this grand source of instant manna. Mrs. Allman passes on these hints and recipes:

She eliminates the problem of starting the sourdough culture of fermented potato by selling small quantities of powder already made up and this seems to the writer to be the safest course.

Select a sourdough pot—a wide-mouthed glass jar or bean pot is ideal. Never use a metal dish or spoon. A wooden spoon is a must.

Dump a packet of sourdough mix into the pot. Add only white flour and warm water to the consistency of thick rich cream.

Be sure to allow space for expansion for sourdough will start "working" immediately and more than double its size.

At night, mix the starter for the morning stack of sourdough waffles or pancakes. Remember, flour and water added the night before, never in the morning when it's to be used.

Recipe for hotcakes or waffles:

Pour into mixing bowl two cups of starter that's been sitting overnight;
add one egg;
two tablespoonsful of sugar;
four tablespoonsful of cooking oil.

When ready to bake, fold in one teaspoonful of bicarbonate of soda stirred in a jigger of water. (Incidentally, Mrs. Allman says it's best to use the little finger of your left hand for this operation as it's generally the cleanest). Then gently mix and the sourdough will thicken and sound hollow like whipped cream.

Suggestion—add blueberries or other small berries to give weight to these extra-light waffles or hotcakes.—A.G.G.

OFFICERS AND MEN

\$3,200 Given To Good Causes

More than \$3,200 was distributed among 20 local, national and international agencies when the destroyer escort *Ottawa* paid off May 24 at Esquimalt for refitting and conversion.

Proceeds of canteens and other non-public fund organizations in the ship were distributed according to the wishes of the ship's company.

Among recipients of donations were the Boys' Club of Victoria, Cerebral Palsy Clinic, Armed Services Leave Centre, Conquer Cancer Campaign, Salvation Army, Red Cross Society, Canadian National Institute for the Blind, YM-YWCA, Well Baby Clinic, HMCS *Naden*, Victorian Order of Nurses, SPCA, Canadian Mental Health Association, Maritime Museum of B.C., Protestant Orphanage, Queen Alexandra Solarium, Canadian Arthritis and Rheumatism Society, Multiple Sclerosis Society, Muscular Dystrophy Association, Canadian Heart Fund and the RCN Benevolent Fund.

Halifax Woman Award Winner

A suggestion by Mrs. Alice A. MacDonald, of Halifax, has earned her a cash award from the Suggestion Award Board of the Public Service of Canada and a congratulatory letter from the Deputy Chief of Naval Personnel, Naval Headquarters.

Mrs. MacDonald's suggestion concerned clerical procedures in use in the Civil Service.

Mrs. MacDonald is the former Alice Anderson of Mulgrave. She entered the Federal Civil Service in July 1943 as a stenographer, and served until June 1948. She later was with the Nova Department of Welfare and returned to the Federal Civil Service in November 1957. She is employed at HMC Dockyard, Halifax, as a Clerk Grade 3.

Officer Enters Church Ministry

Sub-Lt. Kenneth D. Benner, divinity student at Pine Hill College in Halifax, preached his graduation sermon recently in St. Michael's Church, at HMCS *Shearwater*.



SUB-LT. K. D. BENNER

Sub-Lt. Benner was well known to the *Shearwater* congregation since he spent five years as a naval airman before taking academic and theological training at Pine Hill Divinity College for his entry to the ministry. A husky young man, he was a well-known athlete, particularly on naval football teams.

Most Wrens Serve in East

All but nine of the Navy's 178 regular force wrens serve in establishments of the RCN Atlantic Command where more than half are employed in operations centres.

They replace sailors in shore posts involving operations, communications, medicine and supply, helping to maintain the RCN's high sea-shore ratio.

HMCS *Stadacona* employs the most, some 85 wrens. Others are at the RCN Air Station, HMCS *Shearwater*; HMCS *Shelburne*, oceanographic station, and HMCS *Cornwallis*, Annapolis Basin training establishment. Two serve at Naval Headquarters in Ottawa, six are at the medical school in Camp Borden, Ontario, and one is on the West Coast.

He was born in Orillia, Ontario, in 1935, and entered the Navy in 1952. He was promoted to sub-lieutenant in September 1960. At college, he maintained naval connections, serving on special duty in ships and establishments during the summer. He has said that he would like to be a naval chaplain eventually.

At the beginning of June, Sub-Lt. Benner was ordained in the United Church of Canada.

New Structure For Wren Trades

Introduction of a new structure and specifications for wren trades in the RCN has been announced by Naval Headquarters. Revised trade specifications are in course of promulgation.

The new structure includes the following trades: Wren Secretary (SS), Wren Accounts (SA), Wren Medical trades, Communications Operator (CO) and a new trade of Naval Operations (NO), which combines the duties of the former Seaward Defence (SD) and Navigation Plot (NP). The NO trade will comprise the largest number of wrens.

The trade of Wren Personnel Rate (WP) is being retained in the new structure on a transitional basis and specifications are under revision.

The Wren Medical trades are included in the current CFMS trade revision and specifications will be promulgated separately.

Fire Fighters Receive Trophies

Approximately 50 members of the Royal Canadian Naval Fire Service, headed by Lt.-Cdr. Norman Stewardson, Base Fire Chief, gathered at the fire hall of HMC Dockyard, Esquimalt, on May 16 to witness formal presentation of numerous awards to their department by Rear-Admiral W. M. Landymore, Flag Officer Pacific Coast.

To the navy's firefighters, were presented: The Grand Award plaque of the Canadian military division of the National Fire Prevention Association Contest, won by the naval firemen for 1962 in competition with all Canadian military organization;

The Howard Green trophy, won by the Pacific Command firemen for 1962 in competition with all departments within the Federal Government, the second time the RCN personnel have won both of these major awards, repeating honours gained in 1958;

Three Canadian Military Division certificates, and

The Grand Award shield, which is being retained in Naval Headquarters.

The Grand Award plaque was received on behalf of his department by Lt. Gordon C. Ball, assistant base fire chief. Fire Officer E. Powell received the Howard Green trophy on behalf of his fellow firefighters.

Canadian Military Division certificates were presented to Fire Officer E. Powell, representing HMC Dockyard division; Fire Officer I. J. Chidlow, representing HMCS Naden; and Fire Officer I. W. Davies, representing Belmont Park Naval Housing.

In paying warm tribute to the record of the Pacific Command firefighters, Rear-Admiral Landymore noted that fire losses throughout the entire Command (ships and establishments) in 1962 totalled only \$199. He praised the RCN firemen for their year-round fire prevention program.

"Navalaire" Welcomed Back

The end of May saw the welcome reappearance of *The Navalaire*, fortnightly newspaper of HMCS *Shearwater*, after an absence of several months.

The first number of the new series is a 16-page, semi-tabloid production on good quality paper, with what appears to be substantial support from the advertisers—an essential for a newspaper published from non-public funds.

The managing editor is Lt. G. E. (Jan) Salter, photographic officer at *Shearwater*, and his assistant is CPO L. T. Edwards. Circulation is the responsibility of AB W. N. Cridland.

In welcoming the return of *The Navalaire*, Captain G. C. Edwards, commanding officer of *Shearwater*, pointed out that the naval air base is the largest shore establishment in the RCN and that the newspaper had in the past performed a most useful function in disseminating news to naval and civilian personnel serving there.

24 Men, 2 Wrens Earn Commissions

Twenty-four chief petty officers and petty officers of the Royal Canadian Navy have been promoted to the rank of commissioned officer after completing an eight-month limited duty officers' qualifying course at the Fleet School, HMCS Naden.

They began a two-month divisional and administrative course in June, part of which is undertaken at *Cornwallis*, and the balance at HMCS *Hochelaga*.

Following the course they will take up appointments with the fleet.

Two other graduates of the class were Wren PO Shirley N. Stretton and Wren Anne B. Knight, each of whom was promoted to the rank of sub-lieutenant and appointed to *Cornwallis* for an officers' divisional course.

The new commissioned officers are: H. D. Abbott, H. F. Bailey, J. H. Barlow, C. J. Brooker, G. J. Bruneau, J. M. Chute, R. J. Collin, D. E. Deane, A. F. Debaeremaeker, M. H. Droske, J. B. Forbes, W. G. Hillaby, W. J. Holloway, J. R. Jones, T. J. Jones, N. R. Marsaw, J. F. McGuire, H. D. Mercer, R. G. Parish, A. J. Ross, C. J. Shepherd, V. R. Vandewater, C. B. Webb, and J. W. Wood.

Sackville Joins Northern Cruise

When the Canadian Naval Auxiliary Vessel *Sackville* sailed for the far north in May as part of Canada's contribution to the special program of the International Committee on North Atlantic Fisheries, she carried a member of the RCN's meteorological staff from *Shearwater*.

PO John Hebgin sailed with the *Sackville* as a meteorological observer.

The *Sackville*, a former corvette sailing with the ICNAF fleet, is engaged in an oceanographic and biological survey.

Ships representing Denmark, France, West Germany, Iceland, the United Kingdom, Russia and Canada are included in the special survey which is covering an area of more than 1,000,000 square miles. The area lies off the southern coast of Greenland and the Canadian shore of Davis Strait.

PO Hebgin is looking after ice and weather forecasts and reports for the Canadian ships CNAV *Sackville* and CCGS *Baffin*. He joined the *Sackville* May 20.

It's 'Up Periscope' at the Crow's Nest

"Up periscope!"

This could well be the cry that marks the opening of official business at the old Crow's Nest Club in St. John's, Newfoundland.

The club was founded in January 1942 as a Sea-going Officers' Club for naval and merchant service officers visiting the Old Colony, was closed for a few months after the Second World War and then reopened as a club for serving and former officers of the three armed services and merchant service.

That it is still largely nautical in character is attested to by the fact that it is now navigated by periscope. Members, if they are so minded, can inspect the rooftops and waterfront of St. John's through what was once the all-seeing eye of the German submarine U-190.

The U-190 surrendered to HMCS *Victoriaville* off Newfoundland on May 12, 1945. She was escorted to

Bay Bulls, paid a brief visit to St. John's and then operated out of Halifax under the White Ensign for a couple of years. Stripped of valuable equipment, the U-190 was taken to sea in the summer of 1947 and sunk in an anti-submarine exercise.

The periscope had been placed in the custody of the Maritime Museum of Canada in Halifax. Now, through the efforts of Commodore E. N. Clarke, Commodore Superintendent Atlantic Coast and Superintendent HMC Dockyard, Halifax, a charter member of the Crow's Nest Club, the periscope has been returned to the first land it visited as part of a recently Canadianized submarine. It took a crane with an impressively long boom to lower the periscope to the roof of the club on the top floor of a four-storey building on Haymarket Hill on a recent quiet Sunday.

"Time, gentlemen! Down periscope".



When ships of the USN's Cruiser Destroyer Flotilla Six saw a Canadian Tracker circling above them they were unaware of the presence of their commander, Rear-Admiral J. W. Ailes, right, who had been flown out to sea from Charleston, S.C., by Lt. K. P. Sheedy. (Official USAF Photo)

U.S. Admiral in RCN Helicopter

One of VS 880's commitments while deployed to the USAF base at Charleston, South Carolina, in June, was to co-operate in anti-submarine exercises with Cruiser Destroyer Flotilla Six of the United States Navy.

Rear-Admiral J. W. Ailes, Commander of Cruiser Destroyer Flotilla Six, showed a keen interest in the operations of his CRUDESFLOTSIX. He flew with Lt. K. P. Sheedy, RCN, in a Canadian Tracker, to gain first hand knowledge of progress being made. The USN ships were totally unaware of the presence of their commander. Lt. Sheedy said he carried out his normal tasks while the Admiral just sat back and observed.

The admiral caused some little degree of consternation in his ships, however, when he spoke to them before leaving, identifying himself with his personal call sign. After the plane had landed at Charleston Air Force Base, the commanding officer of VS 880, Cdr. R. C. MacLean, presented Admiral Ailes with a copy of the squadron badge.

In Charleston, as always, the USN showed every consideration to the RCN. Admiral Ailes sent Lt. Sheedy a letter thanking him for his flight in the Tracker and praising his proficiency as a pilot and ASW tactician.

Prevost's Captain "Towed" Ashore

Traditional naval protocol for retiring commanding officers was followed as closely as possible for Captain G. A. Maclachlan when he relinquished com-

mand of the London naval division, HMCS *Prevost*. Lack of navigable water, however, led to a one-letter change which made "rowed" into "towed".

When Captain Maclachlan's retirement came up, personnel at the division fabricated a likeness of a boat, mounted it on a dolly and decided to let their parade square double as the ocean. Appropriate signs adorned the stern and superstructure, like "Wot! No water?" under a Kilroy-was-here face.

After Captain Maclachlan had climbed on board the single-masted craft to mark his formal retirement, his officers towed him around the parade to the resounding cheers of his assembled ship's company. He had served in the reserve for 23 years, of which the last four-and-a-half were in command.

Following a march-past, Cdr. D. W. Paddell witnessed the signing of the change of command document in which Cdr. H. W. Littleford took over.

Captain Maclachlan's last official act was to present two Canadian Forces Decorations.

Prevost's new executive officer is Lt. G. A. Baker.

Seven Awards for Supply Depot

One award of honour and six certificates of merit were presented to the Aviation Supply Depot, Dartmouth, at the 44th annual meeting of the Nova Scotia Accident Prevention Association.

The award of honour is for companies, employing 20 or more employees, which have operated 365 days without a lost-time accident.

Certificates of merit are awarded to departments or groups of departments, employing 20 or more employees, which have worked a calendar year without a lost-time accident.

Awards were presented to the various supervisors by Cdr. R. V. P. Bowditch, Officer-in-Charge, Aviation Supply Depot, Dartmouth. It was pointed out that the award of honour achieved by the depot was one of 14 awarded by the Nova Scotia Accident Prevention Association throughout the province.

CORRECTION

Four lines of type were transposed in the article, "Trade Advancement Ceiling", on page 12 of the May issue of *The Crownsnest*. Lines three to six inclusive should have appeared at the end of the text. In addition, the figure for Underwater Weaponman in the Esquimalt Port Division advanced to Trade Group III should have been "7" rather than "6".

Reserve Wren Officer Promoted

Promotion to the rank of lieutenant-commander is a rare achievement for a wren. Only three wrens have that rank in the Royal Canadian Navy and one in the RCN Reserve.

Provision exists for just one lieutenant-commander in the RCNR structure and, as a matter of fact, only two have held that rank since the return of wrens to the Reserve in 1961.

The first was Lt.-Cdr. Carol Sellars, of HMCS *Discovery*, Vancouver naval division, who is now on the retired list.

The second to achieve this rank is Lt.-Cdr. Edith J. Williams, of HMCS *Chippawa*, Winnipeg naval division, who was promoted on April 22.

Lt.-Cdr. Williams joined the war-time WRCNS in Regina on January 6, 1945, as a probationary wren writer. She served in several establishments including HMCS *Conestoga*, Wren basic training establishment at Galt, Ontario, during the Second World War. She left the service April 22, 1946, as a wren writer.

When the wrens were reorganized, she enrolled in October 1951 in the rank of acting sub-lieutenant and assumed the duties of wren divisional officer in HMCS *Queen*, Regina naval division.

In 1956 she was transferred to Winnipeg by her civilian employers and joined *Chippawa*. Her promotion to lieutenant was confirmed in June 1959, although she had held the acting rank of lieutenant since June 1955.

In civilian life she is secretary to the Dean of Dentistry at the University of Manitoba.

Chippawa boasts the largest wren division in Canada, with a full complement of 50, and much credit for this achievement must go to Lt.-Cdr. Williams.



LT.-CDR. EDITH WILLIAMS

DENTAL THERAPIST

IN THE Royal Canadian Dental Corps clinic in HMC Dockyard, Halifax, the dental officer prepares a patient's tooth, straightens up and leaves the cubicle. He also leaves a mystified patient.

But not for long.

Sergeant-Major (WO2) Hilton Thorsson, Danish-born, B.C.-educated, moves in quickly and continues the treatment. As a "Technical Dental Therapist", he's the only one of his kind in the Halifax area and one of three to date in the Royal Canadian Dental Corps.

Sergeant-Major Thorsson has been trained to insert fillings, make impressions, carry out minor denture repairs and administer dental first aid. He is the dental officer's right hand man and is trained to do anything which doesn't interfere with the oral structure of the patient. This means he can't give anaesthetics, design dentures, do cavity preparations, pulp conservation or surgery.

This is all part of a study being conducted by the Royal Canadian Dental Corps to determine whether such auxiliary dental personnel can be trained to carry out certain restricted procedures at the chair under the supervision of a dental officer and whether they can be employed effectively in the dental clinics throughout the Corps.

The advent of Sergeant-Major Thorsson as a therapist at the beginning of this year in the clinic heralds a trend in the Dental Corps of equal importance, say, to the steps long since taken by hospitals, who permit orderlies to give injections to patients, nurses to handle intravenous feedings, and lab technicians to take their own samples for test. Much routine work thus is removed from a doctor's busy rounds.

Sergeant-Major Thorsson is a direct entry into the Royal Canadian Dental Corps. The corps looks after the dental



Sergeant-Major Hilton Thorsson, left, a therapist, is the dental officer's right hand man in the Dockyard Dental Clinic at Halifax. He works on PO Robert M. Tizzard, ashore from the destroyer escort Sioux, while Major R. E. Dyer, officer-in-charge of the clinic, supervises the treatment. (HS-71615)

requirements of all the armed forces although for purposes of pay and administration it comes under Army auspices, and the personnel are uniformed and ranked accordingly.

The sergeant-major, whose family settled in Langley, B.C., in the 20s, started as a dental assistant in 1951 and progressed to the Trade Group II level. He was selected from that trade for training as a clinical "hygienist" and attained the top trade level (Group IV). Last summer he was selected to take a course of several months at the RCDC School in Camp Borden, Ontario, to emerge as a therapist. His class was small and its graduates distributed to HMCS Naden, RCN Barracks, Esquimalt; the Army's Camp Borden and HMC Dockyard, Halifax.

Major R. E. Dyer, who is in charge of the Dockyard Dental Clinic, considers the work of Sergeant-Major Thorsson and his select breed is one of the more significant things that have happened in the corps in the past 18 years, and "there have been many significant things"

Major Dyer says: "I can see three patients in 50 minutes now, whereas before I saw two in an hour." Since February 1961, when the major took over the clinic, until March of this year, the Dockyard Dental Clinic, which caters largely to sea-going personnel, had a total of 16,649 patient appointments in 405 actual working days. Treatment was carried out by a staff of 10 (all ranks), of whom three were dentists.

Major Dyer, reorganizing his clinic staff to take the fullest possible advantage of Thorsson's welcome qualifications, fervently hopes the trend will continue.

Whether technical therapists will continue to be trained and employed in the Corps will depend on the outcome of the study which has been underway for the past two years and is expected to continue for at least another six months.

Meanwhile, Sergeant-Major Thorsson, who has taken to the work like a duck to water, says, "I'm keeping my fingers crossed."



THE LAST DAYS OF SAIL

Part Three

WHEN BOYS had finished their training in the *Lion*, they awaited drafting as required. Requests would come in for so many boys for the Channel Fleet or the China Squadron or elsewhere. Chance decided their immediate destination. It fell to my lot to go with about 30 other boys to the surveying ship *Egeria* then attached to the Pacific station. We were sent to the depot ship *Agincourt* at Portland to await the rest of the ship's company from Chatham, a crew consisting of 122 ratings and 12 officers. We also had a number of other seamen in the complement who were proceeding to relieve those on the Pacific station who were time expired or who were being invalidated out of the service. In the end we numbered about 200 in all.

At that time, in January 1900, the *Egeria* lay at Esquimalt, the naval base on Vancouver Island in British Columbia, about three miles from Victoria, the capital of the province.

It was considered more economical to send the new ship's company to the Pacific Coast rather than bring the *Egeria* back home round the Horn, for there was no Panama Canal in those days. It was therefore arranged that we should travel by the most direct route and, after everyone had been assembled at Portland, we entrained for Liverpool where we embarked on the Allan liner *Tunisian*. It was not a question of travelling liner fashion for our ship's company. We had to sling our hammocks in the steerage quarters of the ship the same as we had done so often in the *Lion*. We did not know until the *Tunisian* had put to sea that she had only recently carried a cargo of cattle, some of which had been stalled in our accommodation.

IT WAS NO holiday trip for us boys. Each day we were told off to do physical jerks and rifle drill with broomsticks taking the place of rifles. As we swung them to and fro to keep time with the ship's band playing such music hall favourites as "Sweet Rosie O'Grady", "Comrades" and "Waiting at the Church", the passengers seemed to think we were doing it for their benefit. And this was followed by Swedish drill, riding the vaulting horse and doing elaborate tricks on the parallel bars.

Fortunately we were only called on to make a public exhibition of ourselves in the mornings—the rest of the time during the eight-day crossing to Halifax we were on our own.

At Halifax, where we were quartered in military barracks, we had time to look round the town, before getting into a special train the following morning that took another eight days to make the 3,640 miles across Canada to Vancouver.

I suppose it was the most exciting railway journey in the world. We stopped for an hour every day for exercise except when travelling through part of the American state of Maine. I guess the authorities knew a thing or two. If a man deserted on United States

by

Arthur Walpole

soil, it would have been the devil's own job to reclaim him. Not that any such thought entered the heads of our little band of eager boys. We had embarked on a high adventure which had been worth every moment of those days of hardship and near privation in the Devonport training hulk.

Because ours was a special train it moved at a leisurely pace. We seemed to crawl through the long stretches of prairie land, with its miles of tall grass undulating in the breeze like waves approaching a lee shore. There were halts at Montreal and Ottawa and on the shores of Lake Superior. Whenever a long-distance express was signalled our train was shunted into a siding and we watched it thunder by, waiting for a long time before our locomotive got up steam again. We had time to study a special guide book we had been given, with information about places along the line and learned a lot about Moose Jaw and Medicine Hat, although we saw few cowboys and, alas, no Indians.

At the foothills of the Rocky Mountains, observation cars were attached to our special so that we could see the grandeur of the scenery in comfort. At Calgary came an extra engine with a hugh snow plough to keep the track clear and another at the

back to act as a brake when decending steep inclines and to give an extra shove when climbing. Once we had scaled the mountain barrier it was sometimes impossible to see the bottom of the ravine on the side or the summit of the peak on the other. In places the track was covered with snow sheds to avoid danger from avalanches or heavy snowfalls.

There was a six-hour halt at Banff where we watched people skiing and tobogganning, a new experience for most of us. We knew nothing about winter sports but we organized a snowball fight with the locals. They knew much more about such things than we did and that day the British Navy had to acknowledge a signal defeat.

AT AN ALTITUDE of 5,337 feet we reached the Great Divide, where a notice informed us that we were entering British Columbia. The descent was so steep on the other side that it was obvious why a rear engine had been called into service. It was taken off when we came to Revelstoke, at the foot of the western slope of the mountain barrier. And so past Kamloops to Vancouver City.

It took seven hours to cross the Georgia Strait to Esquimalt, the headquarters of the Pacific station, which we reached on March 5, 1900, and the next day Cdr. Simpson assumed command of the *Egeria*.

THE BRITISH NAVY at the turn of the century was a real world force. Its strength was spread over every part of the world. The Pacific fleet was only one of several. There were the Channel Fleet, the Atlantic Fleet and the Mediterranean Fleet and others in the South Atlantic, the West Indies, the China Seas and the East Indies.

The various overseas naval formations operated together. For example the Pacific Fleet based on Esquimalt had a regular rendezvous with the Australian fleet on the annual cruise to Honolulu. The West Indies Squadron, so called, manoeuvred in the North and South Atlantic between Halifax and the Falkland Islands. The East India Squadron had bases at Bombay and in Ceylon and kept an eye on the Persian Gulf to prevent slave traffic. The China Squadron was interested in putting down



The main street of Esquimalt as it appeared at the beginning of the century when Mr. Arthur Walpole, author of the accompanying recollections, was serving out of that port in HMS *Egeria*. (E-28006)

piracy, and we all know the part the Royal Navy played in suppressing the Boxer rebellion and in the relief of the international legations at Peking in 1900. And it was the navy which supplied the 4.7 guns for HMS *Powerful*, commanded by Captain Percy Scott, which were so important in the relief of Ladysmith during the South African War.

The Royal Navy was everywhere, "a security to such as pass upon the seas upon their lawful occasions". It is rather different now when the Dominions and other countries of the Commonwealth have their own naval protection but I like to think, and indeed in my old age I believe, that the same spirit and tradition still prevail as when I was a boy.

The Pacific Fleet was not very big but it was substantial enough. When

I arrived at Esquimalt the flagship was HMS *Warspite* (Rear-Admiral Beaumont), a first class cruiser of 8,400 tons and a crew of 527 officers and men. She mounted four 9.2 guns and ten 6-inch guns and could steam at 16 knots. The second class cruisers *Phaeton* and *Amphion* (each 4,300 tons) were faster, with 16.6 knots and 5,000 horsepower. There were two sloops—the *Shearwater* and *Icarus* (each 980 tons—and the *Condor*, then on her way to join the fleet and to which I shall refer later. The effective strength of the formation was brought up by the two fast destroyers *Sparrowhawk* and *Virago* of 300 tons. The *Egeria* was not a combat vessel. She was employed on marine surveying work off the coast of British Columbia and only joined up with the main squadron in winter time or for the July celebrations of Dominion Day.

THE *EGERIA* was a screw surveying sloop of 940 tons, 160 feet long, with a beam of 31 feet. She was 27 years old, having been built at Pembroke in 1873 at a cost of £42,882. (I wonder what a similar ship would cost today). She drew 14 feet, 3 inches, of water and her only armament was two 20-pounder breach-loading guns and two machine guns—a five-barrelled Nordenfelt and a Maxim, both mounted on high pedestals on top the poop. There was also a brass mortar, originally intended for judging distances, by comparing the rates of light and sound, but long since disused. For the younger members of the crew, it was just something to keep bright and shiny. She carried 100 tons of coal for her auxiliary engines but coaling ship was just as strenuous—and dirty—as for a much bigger vessel, for all the coal had to be carried in baskets through the gun

ports along the deck to chutes. At steam, she could make about 11 knots but she was rigged as a barque and went by sail as often as possible.

The men from Chatham who had travelled 7,000 miles from the Medway to join her were a tough company. Among them were recovered deserters and inveterate drunks who did not care a fig for authority. It was said that they were sent to the *Egeria* so that they could abscond in some obscure place and never be found again. It was also well known that there were agents on the American shore who could be bribed into giving shelter to deserting British sailors. It was all arranged by Jack Day's Hotel, the only hostelry of any importance in the village of Esquimalt. Here contact could be made with American go-betweens who would bring along a suit of civilian clothes and a wad of dollar bills. The money was repaid out of the earnings of the man when he had crossed the border; the percentage demanded was such as would make the most rapacious moneylender flinch. These sharks made a dead set at the crew of the *Egeria* once they knew the type of men that formed the new complement. If a man had a trade such as a blacksmith, carpenter or painter, then the inducement was doubled, but even unskilled men were promised fancy wages as labourers and were induced to desert. And so many did that on one occasion we had such a shortage of hands that we could not put to sea until replacements were sent from the fleet.

Most of the deserters were quite useless on board and the authorities made no undue efforts to recover them. They were just posted as deserters and it was left at that. Our blacksmith was not so lucky. He had deserted almost as soon as we reached Esquimalt and crossed the border where, after a while, he did very well for himself. Two years later he was stupid enough to write to one of his old buddies in the *Egeria* asking him to come down to Jack Day's place to celebrate. All might have been well but somehow one of the officers got wind of what was going on. This was really too much. Had the blacksmith stayed in Seattle no one would have minded very much. But to come and get drunk in the only hotel at the base was going too far. A file of marines was waiting for him. He was court-

martialled and given 90 days, after which he had to serve the rest of his time instead of being discharged.

WHEN WE WENT to sea our job was to survey the inland waters of British Columbia, which had last been surveyed by Captain Vancouver 100 years before. It was mostly in the Strait of Georgia which stretches the whole length of Vancouver Island, some 285 miles from Victoria in the south to Queen Charlotte Sound in the north. It is 20 miles wide on an average, so that we were rarely out of sight of shore. It is filled with little islands and submerged rocks which we had to locate by soundings.

The whole of the ship's company, including petty officers, stokers, "idlers" and seamen were accommodated in a single mess deck. The chief petty officer and the master-at-arms occupied what looked like horseboxes which were so designed that by looking over the edge they could keep an eye on the crew. There was a similar sort of box for the writer who acted as the captain's clerk and for the ship's steward. The first class petty officers messed by themselves as did the stokers. The daymen who kept no night watches, such as the armourer, blacksmith, carpenters, butchers, painters and other artisans, also had their own accommodation. These were the "idlers" to whom I have already referred.

The seamen paid for their own messing, which amounted to a tidy sum at the end of the month. The boys paid nothing, and they could hardly be expected to on their miserable pay. Instead they acted as lackeys and bottle-washers for the older men and petty officers, and took their turn as cooks.

FOOD WAS plain and there was not too much of it. The standard issue of rations when I first joined was flour, cocoa, salt pork and beef, (sometimes fresh meat when in harbour) split peas, salt, ship's biscuit (again bread when in harbour) and lime juice to keep away scurvy. We also had a daily allowance of tea, sugar, preserved fruit and the necessary condiments.

While in harbour there was generally a fair supply of fresh provisions but when we went to sea we could only take on board stocks to last a week. After that biscuits were issued in place of bread. They were hexagonal in shape

and your guess is as good as mine as to how long they had been in the victualling yard. They were as hard as a brick. If you gave them a sharp knock, you would see the weevils fall out. It was the test of a hardened seaman that he could break a ship's biscuit on his forehead. The salt pork disintegrated into shreds when cooked but salt beef remained a hard lump no matter how long it was boiled. And the fat remaining in the harness casks was handed to the cooks to make pastry.

You had a basin of cocoa on turning out, with breakfast at 8 o'clock, dinner at noon and tea at 4.15. After that there was nothing until next morning unless you scrounged some bread and cheese or biscuits. The commander and the master-at-arms went the rounds at nine a.m. and at 10 p.m. all lights went out and you were piped down until next morning. We also had to be very careful about fresh water although we were never rationed.

Each man was issued with a pound of leaf tobacco on the first of the month for which he was charged a shilling. The tobacco had to be stemmed and the stalks returned to make snuff. It gave the leaves added flavour if you steeped them in a little rum before rolling them out in sacking into a "prig". The "prig" became superfine tobacco, so hard that it had to be cut with a jack knife and shredded before using. You could also cut off "quids" for chewing but in all my service I never got round to that.

For a young rating who had no taste for hard liquor the daily rum ration came in as a useful means of barter. You could get a lot of things done for you by the ship's carpenter or the other artisans if you handed over your tot of rum. Even in those days, however, there were many men who went without their grog and took a money allowance instead. It is the same in the service today.

I have mentioned the difficulties about water. In such a small ship it was always in short supply. One tub was sent to each mess for morning ablution and as the boys come last it was pretty grimy when it eventually reached them. The ship's water tank was always kept padlocked and we irreverently parodied a well known hymn "Tanky, tanky, tanky, serve out washing water; all hands are waiting to scrub and wash their clothes".

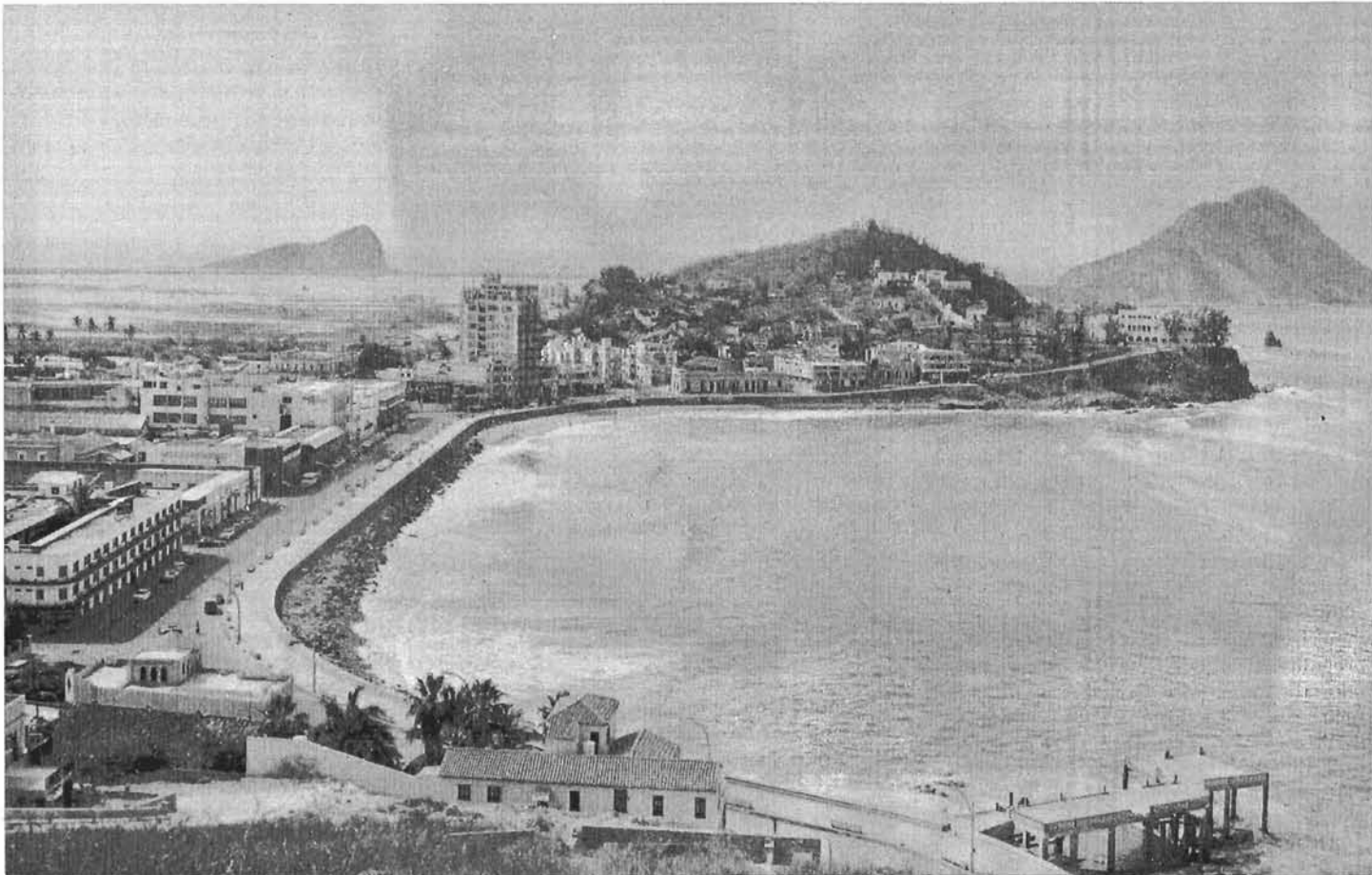

The curving shoreline and conical hills of Mazatlan give the Mexican resort city a small-scale resemblance to Rio. Sailors of the Second Canadian Escort Squadron last spring found Mazatlan an attractive port of call. (CCC2-1137)

A VISIT TO MAZATLAN

FOUR SHIPS of the Pacific Command steamed from Esquimalt on March 25 last on an eventful six-week trip to southern waters.

HMC Ships *Margaree* and *Saguenay* of the Second Canadian Escort Squadron sailed together for gunnery exercises along the way, and the *Skeena* had the honoured task of being a part of the Canadian team guarding the route over which Her Majesty Queen Elizabeth II and His Royal Highness the Prince Philip flew from Australia and New Zealand via Vancouver, to England.

HMCS *Cape Breton*, escort maintenance ship, sailed independently to San Francisco.

Even though it is a relatively short voyage to San Francisco, this one had its moments. After a hasty retreat to Cape Flattery and Port San Juan with a suspected appendectomy case, the ships drove their way southward through a heavy storm off Cape Blanco, something not unexpected at that time of year.

In a matter of hours, the barometer had dropped ominously. All upper deck hands were busy, making last-minute preparations for the storm. The wind increased to 70 knots and the sea changed from glassy hillocks to rough

mountains of black water capped with white foam and blowing spray. Various speeds were ordered in an attempt to ride the sea and swell comfortably and safely, but with little luck. The ship took several heavy waves across the decks and suffered damage to some of the fittings.

Abating as fast as it had built up, the storm was over only a few hours later and was soon practically forgotten. Two days later, on March 29, the *Margaree* and *Saguenay* arrived in San Francisco, berthing alongside at Treasure Island, followed by the *Skeena* and *Cape Breton* the next morning.

San Francisco, with its varied entertainment and sights is a leave port always enjoyed by Canadian sailors and this visit proved to be no exception.

The squadron left San Francisco on April 1 and the next few days were busy ones on two counts. Her Majesty's Canadian Forces afloat had the opportunity to exercise their right to vote in the



PO A. J. Eaton, of HMCS *Margaree*, poses with the impressive catch he made during a fishing expedition off Mazatlan, Mexico.

Federal general elections. The polls for the first three days of April gave those involved in evolutions plenty of time to vote. The remainder of the time on this leg of the journey was occupied in exercising with the *Cape Breton*. The keynote of the exercises was alongside replenishment both at night and during the day. Keen competition amongst the three desiroyer escorts increased their speed and efficiency in this evolution.

Arriving in San Diego on April 5, the ships commenced a pleasant 10-day stay. The squadron took advantage of the excellent training facilities offered by the USN to send several sonar-men to the naval ASW School. Captain G. H. Hayes, Commander Second Canadian Escort Squadron, and his staff visited the ASW School, Anti-Aircraft Warfare Training Centre and Navy Electronics Laboratory. Early in the week, Captain Hayes paid official calls on Rear-Admiral A. E. Loomis, Commandant, 11th Naval District, and Vice-Admiral R. T. S. Keith, Commander, 1st Fleet.

But all was not work in San Diego—"Make and mend" routine was carried out whenever possible. Twice the USN organized much appreciated tours of the San Diego area. RCN personnel were invited to use the recreational facilities of the USN and passes were given to the city's world-famous Balboa Zoo. Early Saturday morning, two bus-loads of men, composed mostly of ordinary seamen who had not previously visited San Diego, left for Disneyland. Even those for whom it was a second trip thoroughly enjoyed the excursion.

Three days of the next week at sea were spent exercising with USN submarines, ASW ships and aircraft. By this time, the *Cape Breton* had left San Diego for home. When working with the Americans, an invaluable exchange of information takes place on both sides. Recently learned new techniques, their merits or their faults can be assessed, thereby permitting the USN and the RCN to improve their ASW capabilities to a common end.

On April 20, an unscheduled stop was made in one of the Pacific Fleet's favourite hiding places, Magdalena Bay. Ships' companies took advantage of the quiet night at anchor to hold "banyans" on the quarterdeck. The party on board the *Margaree* proved to be a smashing success, not soon to be forgotten. Early the next morning, all ships weighed anchor and set course for Mazatlan, Mexico. It was evident that the ships were finally in Mexican waters as the temperature rose to 74°F; the tropical sea also took on its characteristic smooth, rolling, glassy appearance.

The visit to Mazatlan, commencing April 22, began with Captain Hayes making his official calls on the Mayor, the Canadian Ambassador, the British Vice-Consul, the Naval Zone Commander and the Governor of the State of Sinaloa. He was accompanied by Cdr. J. L. Panabaker, commanding officer of the *Margaree*, Cdr. R. H. Leir, captain of the *Skeena*, and Cdr. H. R. Tilley, in command of the *Saguenay*.

Mazatlan is on the mainland coast of Mexico, opposite the tip of Lower California. Of two main industries, cotton-browsing and shrimp-fishing, the latter is probably the more important, some 20,000 tons of shrimp being exported annually to the United States alone. Of late Mazatlan has come to be known as a fine tourist resort area, being advertised as the "Pearl of the Pacific". Among the most fascinating attractions to the visitor are the sweeping, white sand beaches, which stretch for miles along the coast. The water is warm and sections of calm beach can be found by those who like to swim, or pounding waves by those who like to romp in the salty surf.

Recreational facilities for the spotsman are almost unlimited. Local waters abound with such game fish as marlin, sailfish and tarpon. Fishing expeditions undertaken by several sailors were rewarded with catches of sailfish or marlin. The name Mazatlan is derived from two Indian words meaning "the place of the deer", indicating the plentiful supply of wild game in the nearby area.

From the moment the ships arrived, sailors were greeted by the colourful

local merchants whose wares varied from bright-hued serapes to intricately tooled leather purses. The latter were very popular items. Mexicans are a highly musical and entertaining people and singing or playing can be heard any time of the day or night. Mazatlan residents are also primarily a night-life people, midday under the blazing sun being far too hot for much activity. Fine Spanish guitars provide gay high-spirited entertainment in the night clubs and cabanas.

The squadron was challenged to a basketball tournament by the cadets of the Mexican Naval Training School. Although it was a close battle, the physical training program of the naval cadets proved its worth and they came out, happily, the victors. On Saturday, April 27, the *Mackenzie*, under the command of Cdr. A. B. German arrived to join the squadron in Mazatlan, after her journey from Halifax through the Panama Canal. While still in the Atlantic, she passed and hailed a sister ship, the *Saskatchewan*, which she has replaced on the West Coast.

On Sunday morning before departure, the local populace observed the ships at ceremonial divisions and church in whites. Ship's company photographs were taken on respective forecastles. At noon, the squadron sailed for Esquimalt, arriving on May 5.

At the entrance to Esquimalt Harbour, Rear-Admiral W. M. Landymore, Flag Officer Pacific Coast, boarded the *Mackenzie* and sailed with her into harbour to welcome her to the Pacific Fleet.



A street vendor in Mazatlan, Mexico, tries to interest Petty Officers William Koch and Harvey Johnson in a colourful serape. (CCC2-1142)

Home from the Sea



Veterans Give Cadets Boathouse

A fine example of the comradeship that exists between men of the sea has been seen in the Sault this week by the presentation at Clergue Park of a boathouse. The presentation was made by members of the Naval Veterans' Association in the Sault to local units of the Sea Cadet Corps and the Navy League.

The spacious building— 26 by 40 feet—with a ramp leading down to the water, will be invaluable to the young sailors. Until now they have had to struggle nearly 100 yards across the highway and the park, carrying their heavy boats from their headquarters to the water.

This has tended to put a blight on the boating activities of the boys. Many of them are only small and can't be expected to help lift a navy longboat. The only snag this year is that the river level is extremely low and water barely laps to the bottom of the ramp.

The Naval Veterans, who badly need a new building for themselves, decided two years ago to put aside their own projects for the sake of the boys. Since then a "hard core" of about 18 members of the Naval Veterans have given up their spare time to building the boathouse. The Veterans' Association has raised over \$2,000, by competitions, for materials.

They had help from local companies for some of the materials. The Parks Board leased them the 100 by 100-foot site at a nominal fee. A lot of lumber came from the temporary office building at Mannesmann Tube Company's plant when it was pulled down for a new building.

The veteran seamen toiled for long hours last summer, transporting the timber and putting it into the boathouse. It was common for them to start right in with the building after work, as soon as they'd finished their supper. "Some of the wives got a bit fed up with it," said one member.

A lot of concreting had to be done to the floor of the boathouse and the surrounding area and that cost the most money. Roofing had to be bought. The metal flag pole was donated, though one of the veterans did the welding on it.

When he attended the dedication ceremony and key presentation Sunday, Captain Eric P. Earnshaw of Ottawa said, "It is an excellent thing that the older generation of sailors has been able to do something as valuable as this for the younger men."

Though their sea-going days are over for most members, the Naval Veterans will no doubt get renewed pleasure out of seeing the cadets learning about boats. And the present location of the boathouse will enable members of the public to watch the activities as well.

The Naval Veterans' aim now is to increase their membership. They have 70 paid-up members though they believe there is a potential membership in the Sault of 600. For servicemen this is a worthwhile organization that combines social activities with service. This boathouse will serve as a monument to their work.

—An Editorial in the *Sault Daily Star*, Sault Ste. Marie, Ont., May 9, 1963.

K-W Veterans Name Officers

The K-W Naval Veterans' Association, of Kitchener and Waterloo, Ontario, with headquarters in the latter city, has named the following to manage its affairs for 1963-64:

J. A. Fromm, president; J. T. Doerner, past president; L. W. Pfeiffer, vice-president; J. J. Blake, secretary; D. R. Durbin, treasurer; W. D. Ross, assistant secretary; H. F. Stumpf, master at arms; W. D. Ross, CNA delegate, and committee chairmen K. C. Buss, D. R. Woelfe, J. A. Armstrong, H. T. Williamson, E. A. Kaufman, O. Hures, A. J. Horley and J. A. Armstrong.



Setting aside for the time being their own requirements for new quarters, members of the Sault Ste. Marie Naval Veterans' Association built and presented to local sea cadets a much-needed boathouse. This was the flag-raising ceremony at the dedication of the new structure.

The End of HMS Seraph

THE LAST of the British "S" class submarines, HMS *Seraph*, paid off for the last time on November 7, 1962, at HMS *Dolphin*. The final triumph of her long and distinguished life was achieved when she reached her "majority" on the preceding October 25. This was the 21st anniversary of her launching at Vickers Armstrong, Barrow-in-Furness, on October 25, 1941. At the time of this birthday she was the oldest submarine in commission in the Royal Navy.

The *Seraph* was one of a line of many modified and improved "S" boats built since the first was designed and ordered in 1929. She belonged to a class of submarine that was to fight with distinction in every theatre of the Second World War, and to provide useful service for the Royal Navy until November 1962.

Of medium size, the "S" class was originally designed for use in the North Sea and the Mediterranean. The boats were simple in design and reliable. The fact that in the *Seraph's* final year there were no major defects, testifies to the quality of workmanship that went into her building.

HMS *Seraph* is of interest to Canadians for three reasons. Two of these concern the Second World War and the third, the recent part of that post-war period.

Firstly, she was the submarine, then known as P.219, under the command of Lt. N. L. A. Jewell, RN (now Captain Jewell, MBE, DSC, RN), that landed General Mark Clark and his party, consisting of General L. Lemnitzer (now Supreme Allied Commander, Europe) and two colonels, in North Africa in an attempt to obtain French co-operation for the forthcoming operation "Torch".

The Americans had believed that their friendship with France since 1940 gave them a political advantage over the British, and that when they arrived in North Africa they would be hailed as liberators. To help them to achieve this, they thought that by obtaining the help of General Giraud, then the hero of a spectacular escape from a German prison and by getting him out of Vichy France to join their troops in Africa, they would have someone around whom all loyal Frenchmen would rally. The British, on the other hand, knew they were not too popular with the French at that time, and so were agreeable to sending an American. The Americans could not use one of their large ocean-going submarines in the Mediterranean. As a result, the *Seraph* sailed with two captains for the operation, the actual captain, Lt. Jewell, RN, and the "political" captain, Captain Jerauld Wright, USN (now Admiral Jerauld Wright, USN(Ret)). Their task was successful. A light-hearted reminder of his episode was displayed in the *Seraph* for the rest of her life. This was a brass plate over the door of the wardroom heads stating "General Mark Clark Sat Here".

The second part of this operation consisted of the *Seraph* arriving 20 miles east of Toulon to take off General Giraud and his party, consisting of his son, his aide-de-camp and a staff officer, Major Beaufre. This was scheduled for November 6, 1942. On November 7 another submarine, HMS *Sibyl*, Lt. E. J. D. Turner, RN (now Captain Turner, RN), Captain S/M, First Submarine Squadron, at HMS *Dolphin* arrived to collect the remainder of the party, which included Madame Beaufre and officers of General Giraud's staff. The *Seraph* had been delayed somewhat and

it turned out that the *Sibyl* went in as the *Seraph* came out. In fact they heard each other on their sonar. Had they been at the same depth it might have been a different story.

As we all know, the operation was successful, although the taking of a French general who later demanded the supreme command of all Allied forces in Africa and an immediate invasion of France as the price of his co-operation, made things complicated. In fact, the subsequent negotiations were carried out with Admiral Darlan. The operation is described in the book *The Ship with Two Captains*.

Secondly, the *Seraph* was the submarine, again under the command of Lt. Jewell, that launched the body of "Major Martin", or the "Man Who Never Was", under the codename "Operation Mincemeat". The idea arose from an incident, just prior to the North African landings, when a Catalina flying boat crashed off the coast of Spain and the bodies of the passengers were washed ashore at Cadiz. One of the passengers, a naval officer, was carrying a letter disclosing the fact that operations in North Africa were about to take place. Fortunately the letter was recovered before the German agents in Spain could get their hands on it, but the idea stayed, and under the direction of the Hon. Ewan Montague, operation "Mincemeat" was developed.

The body of "Major Martin" was washed ashore on the coast of Spain as planned. Attached to his wrist was a briefcase containing false information about the forthcoming invasion of France. This information was directed at the Germans in Spain and they swallowed the bait. It has been stated that this led to the Germans withdrawing



some of their infantry and armour from the invasion areas thus saving many Allied lives. This story is told by Ewan Montague in his book *The Man Who Never Was*. To this day the identity of "Major Martin" is known only to a few people who were closely connected with the operation, in spite of efforts by some members of the press to obtain it for publication.

After these "cloak and dagger" operations had taken place, the *Seraph* found herself with an overstrained hull, due to an unplanned encounter with the sea bottom in more than 500 feet of water. Thus she was among the first "S" class submarines to be withdrawn from operations and in 1944 was converted to a fast A/S target, or "Slipper (S) Boat", as they later became known. Her bridge was streamlined and the torpedo tubes and attack periscope removed. Later she had 46 tons of steel padding added to convert her to a torpedo target submarine, the role she played until the end of her life. Her last year in commission was spent both in this role, working for the Royal Navy and Royal Air Force, and occasionally acting as a trials submarine for the development of new torpedoes. This work took her to Plymouth, Portland, Londonderry and Lochs Long and Fyne in the Clyde areas.

Perhaps the most disappointing incident of the year came on a Tuesday afternoon in the Plymouth areas immediately before a planned operational visit to Bristol. She was acting as a target for HMS *Alaric*, when on the last run of the day the *Alaric* hit her with a salvo of two Mk. 20 torpedoes. This wiped off one propeller and damaged the blades of the second and resulted in her being towed ignominiously into Devonport and spending a long weekend in a drydock instead of at Bristol. The *Alaric* bought many a drink to pay for her good aim on that afternoon.

The *Seraph's* 21st birthday was celebrated by a mess dinner in HMS *Dolphin* on October 25, and it was attended by as many of those who were connected with the submarine during her lifetime as could spare the time. Among the VIPs were the Hon. Ewan Montague, QC, and Colonel Giraud, the general's second son, who had come from Paris for the occasion. Unfortunately, General Mark Clark and Admiral Jeraud Wright could not attend, and General Lemnitzer had been expected but his duties with NATO intervened. The hosts for the dinner were *Seraph's* first captain, Captain Jewell, RN, and her last captain, Lt. H. N. M. Thompson, RN.

Finally, having been commanded simultaneously by two captains, one British and the other American, the *Seraph* in her last years saw the addition of Canadian officers and men to her crew. When she paid off there were five Canadians serving in her. The RCN officers who had served in her are Lt. M. H. Tremblay, Lt. J. B. Elson and Lt. E. R. A. Cullwick.

The *Seraph's* last few days in commission were spent taking training classes to sea for day trips. These classes contained Indian and Pakistani officers and men and so, right up to the end, she continued her multi-national role in the Navy.

The *Seraph* is now sitting in the "Knackers Yard" at Petrol Pier, HMS *Dolphin*, awaiting her final disposal, which will probably be for razor blades. There was a move afoot to present her

to the U.S. as a monument to Anglo-American co-operation in the last war. She was to have been embedded in concrete on the campus of the Military College of South Carolina, at Charleston, S.C., under the sponsorship of the president of the college, General Mark Clark. Those of us who finished the commission in her had hoped that we might steam her across and take part in the celebration. This fell through, for various reasons, but the planes and helm wheels, the bell and the complete fore-hatch are being removed and sent instead.

The *Seraph* has now been replaced by HMS *Otter*, one of the new Oberon class boats modified to act as a target submarine. There is no place for an "oldie" like the *Seraph* in today's submarine fleet, but she has certainly earned her place in *Dolphin's* Hall of Fame.—E.R.A.C.

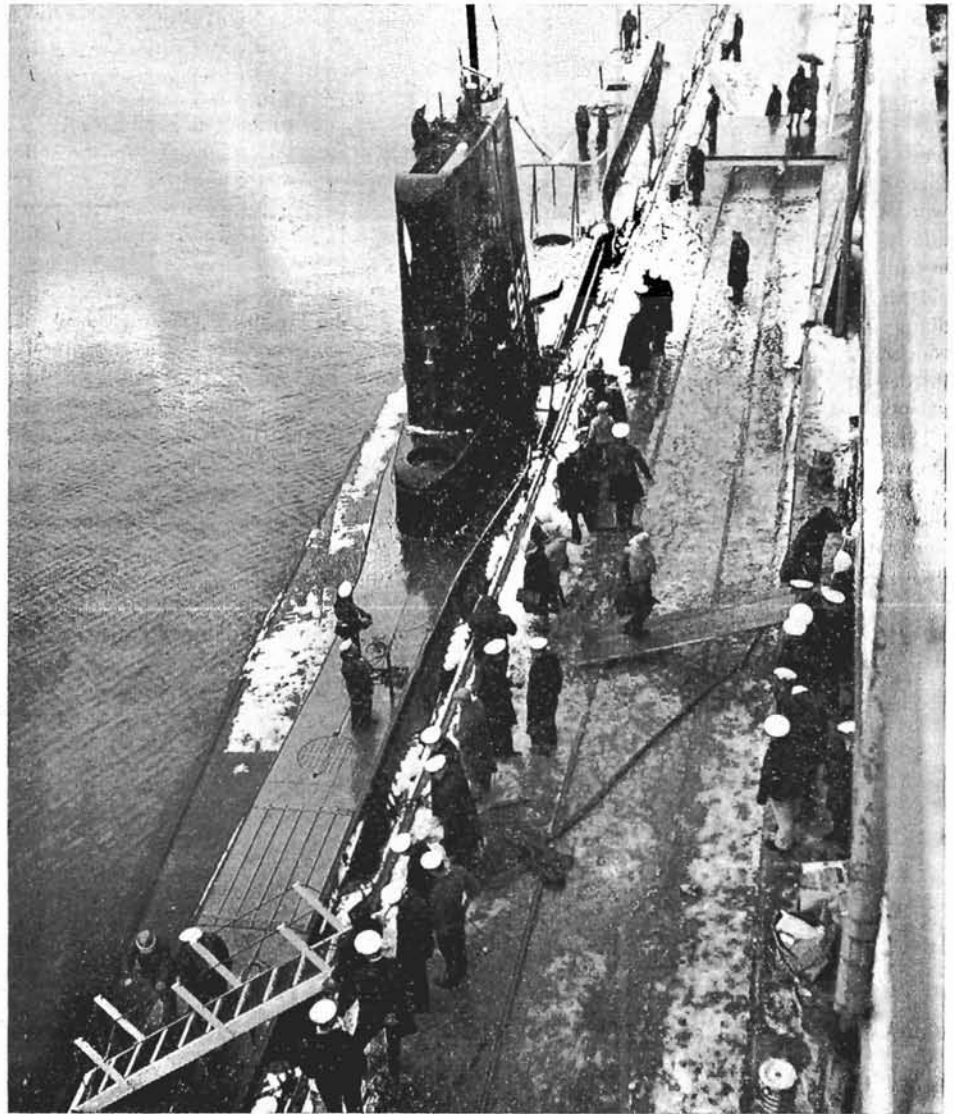

HMS *Alderney*, her paying off pendant ready to let fly, prepares for departure from Halifax on April 12 for Portsmouth after 15 months on the Halifax station. The *Alderney* was accompanied on the ocean crossing by RFA *Saxonia*, an ocean tug based in Scotland. (HS-71667)

HERE AND THERE IN THE RCN



Miss Therese St. Denis won the title of "Miss Navy, 1963" at Naval Headquarters in April. A typist in the Directorate of Naval intelligence, she was a student before her appointment to the Department of National Defence in July 1957. Congratulations and a bouquet of roses are bestowed by Captain Peter Cossette, Director of Naval Manning. (O-14935)



Ldg. Sea. Dennis McAffer is tested on the reaction meter used in the special Safe Driving program for naval personnel from ships in the Dockyard June 4. The program went to Stadacona and Shearwater on succeeding days. (HS-72185-3)



A warm reception awaited HMCS Mackenzie when the new DDE reached her home port of Esquimalt on the sunny afternoon of May 5. A big hello by two-year-old Lee was returned with an equally big Mexican hat from his Dad, PO William (Jerry) Pearson, whose home is in Victoria. (E-71915)



For the first time the Cornwallis Troop can boast four Queen Scouts in one year. They are shown with their fathers who have spent much time in youth activities and especially in helping to develop the Digby Districts Scout Camp. Left to right are PO Arthur Turpin and son Gregory, Warrant Officer John Shiner and son Donald, CPO James Watson and son Robert, and CPO Kenneth Blake and son Ivan. (DB-17845)

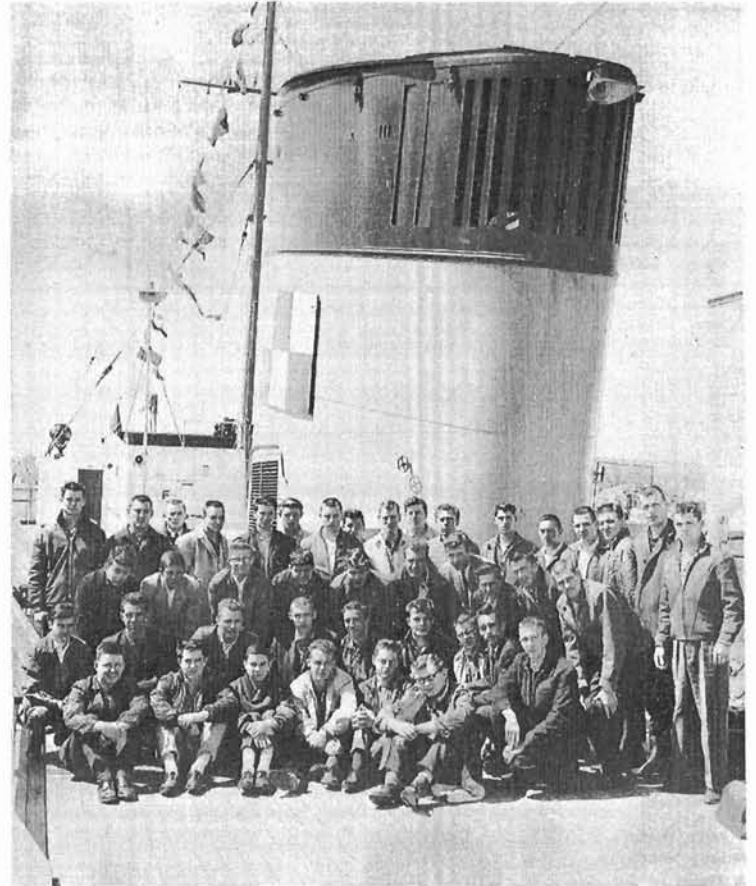

The Princess Helene, after 33 years of fair and foul weather on the Bay of Fundy, said good-bye April 27, a fine, brisk spring day, to Digby residents and the nearby base of HMCS Cornwallis. A salute from the Navy was fired from a 12-pounder by new entries of Gatineau division with PO Donald Bedard in charge. Two days later the Princess of Acadia (ex-Princess of Nanaimo) steamed into Digby at the start of a new career. On hand was the Cornwallis band to help in the festivities, while on board were new entries arriving to form the main body of the Margaree Division. (DB-17851; DB-17853)



The senior class, 40 strong, from Nova Scotia's West King High School, toured Shearwater May 24 and posed before a CS2F-2 Tracker of VU 32. They also saw a Sikorsky HO4S-3 helicopter of HU21 and viewed the naval film "Wings for the Fleet" (DNS-31099)

THE IMPRACTICAL K-BOATS

ANY INVENTOR who tried to persuade the Admiralty to build a submersible steamship, complete with two folding funnels, boiler room, air intakes, and other steamboat accoutrements would doubtless be firmly removed from Their Lordships' presence. In normal times, that is.

But the autumn of 1914 was far from normal. Five of the proudest ships of Britain's "sure shield" lay at the bottom of the North Sea, sunk by unseen U-boats. The remainder of the fleet was ordered to remain in harbour until some solution to the problem could be found. All too late the Royal Navy realized that only 17 submarines of its neglected force of 64 boats could be safely employed outside coastal waters.

Unable to recognize the real significance of submarines back in those years, despite the German navy's excellent demonstrations at every harbour mouth, the British decided they must build a class of submarine fast enough to manoeuvre with the fleet in tightly stationed flotillas. The top speed available from diesels was 21 knots. So the Admiralty decided to hold out for steam-driven submarines capable of 24 knots or more on the surface.

And so the "K" class was born. Designed by D'Eyncourt in 1913, and built by Vickers at \$1,500,000 each, the K-boats were 338 feet long, displaced 1,700 tons, and had a 3,000-mile cruising range, mostly on the surface.

Their armament included four 21-inch torpedo tubes in the bows, four similar tubes trained on either beam, and two 4-inch deck guns.

The K-boats were the biggest, fastest and most powerful submarines to be

launched until the first American nuclear submarines left the ways 40 years later. Few destroyers of the First World War could match their length or tonnage.

But they were one of Britain's costliest shipbuilding failures. Their diving planes, control surfaces, valves and ballast pumps could not control the ungainly size of the K-boat at its low submerged speeds. The hull was weakened by too many openings. Of the 17 K-class submarines launched between August 1916 and May 1918, 16

BOOKS for the SAILOR

were involved in major accidents. One sank during trials. Three were lost in collisions. A fifth disappeared at sea. Another sank in harbour. Nearly all struck bottom at regular intervals in the shallow North Sea.

"K for calamity," said the desperate officers and men who manned them, and called themselves the "Suicide Club". One of the legends of their doomed flotilla is a conversation alleged to have taken place between a captain and his first lieutenant: "I say, Number One, my end is diving. What the hell is your end doing?"

The most disastrous chapter in the K-boat story was probably "The Battle of May Island" on January 31, 1918,

when nine K-class submarines steamed out of the Firth of Forth in line-ahead with 10 battleships and cruisers ahead and astern.

Modern submariners hate surface consorts, even with radar to help out. But the K-boats of 1928 steamed darkened at 20 knots with only two cables of water between themselves and the cruisers and battleships astern. And on this particular night the steering gear jammed on K-14. Within a few minutes three submarines were sunk and four more damaged.

"It looks as if there was something wrong with the standard of efficiency of the officers," commented the First Lord of the Admiralty in a memorandum to the First Sea Lord a few days later. Their Lordships never questioned the K-boat's qualities, or the planning that produced such night rehearsals for classical fleet manoeuvres.

Even after the 1918 Armistice, the Royal Navy continued to commission—and lose—more K-class submarines. The last three were renamed "M" class and equipped with 12-inch guns as submersible monitors. M-1 was lost with 69 officers and men on November 12, 1925, off the Devon coast, probably after being rammed by a Swedish freighter.

M-2 was fitted with a seaplane hangar. She vanished January 26, 1932, with 60 men on board, off Portland. Her wreck was found, with the hangar door partly open.

M-3 was converted for minelaying, but was scrapped by the Admiralty in 1933, just 20 years after the first drawing of the type had been seen by the Admiralty.

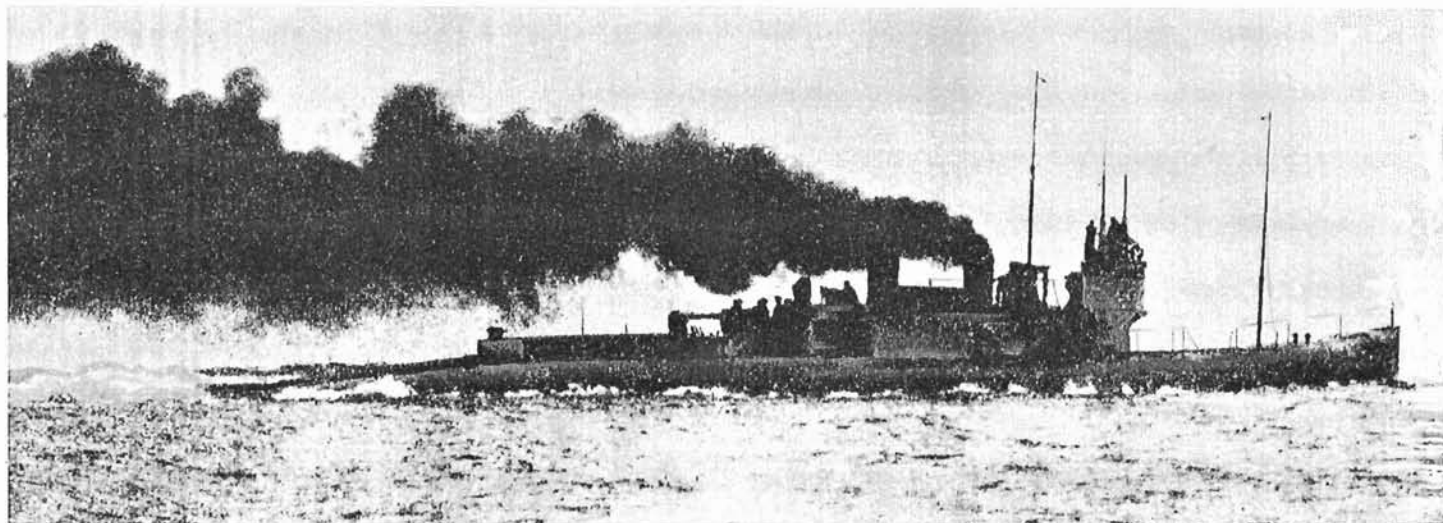

Mr. Everitt's excellent, but brief book on the K-boats is well furnished with photographs and plans of one of history's saddest experiments in ship-building.—K.E.G.

THE K BOATS, by Don Everitt, Clarke Irwin and Company, Limited, Toronto; \$4.25.

COLD WAR

THE COLD WAR of the 1960s in the dismal seas between Greenland and Iceland is the setting for the current best seller *The Bedford Incident*, a fictional account (bristling with very accurate facts) about mortal combat between a mighty USN destroyer-leader and a Soviet submarine.

USS *Bedford* possesses every anti-submarine device from scanning sonar to ASROC, with a dedicated captain and a crew who keep themselves in a permanent state of "WUP-mindedness". In the end, their tautly stretched nerves and eternal vigilance congeal into a sort of hypnotic trance.

The Soviet submarine is just short of being nuclear: it's a hydrogen-peroxide-powered boat of exceptional speed and agility, capable of diving to a thousand feet or more.

Through endless exhausting exercises the two craft come into frequent conflict, but are prevented from taking any hostile action by the rules of peacetime protocol on the high seas. The climax occurs when the American captain finally traps the Russian inside Danish territorial limits on the Greenland coast. He signals for approval to "challenge and interdict" the trespasser while remaining in contact. NATO headquarters consents, and the Americans prepare to attack.

At this moment the U.S. Naval headquarters orders the *Bedford* to do nothing that might aggravate another Berlin crisis. So for days and nights without sleep the American ship merely tracks the submarine, and finally—you guessed it—loses contact.

Instantly, of course, comes a message from CNO allowing the destroyer to make an attack if the Russian fails to

surface and identify himself. Hours later, with the destroyer-men half stunned with exhaustion, they detect the Russian once again, blowing tanks to reach the surface in a last desperate bid for safety.

What happens next forms *The Bedford Incident*: a timely warning, perhaps, for those who are tempted to drive sailors and ships too hard and too long under the illusion that this protects the world from war.

The Bedford Incident is exciting reading for landsmen and seamen alike. But it will be specially rewarding for RCN personnel who are all too familiar with the hardships and problems of the anti-submarine task. Mr. Rascovich writes with a sure, professional knowledge of his subject.

The Bedford Incident is a "must" for every ship's library, and will help many a flagging submarine hunter to see his duties in a "glamourized" light.—K.E.G.

THE BEDFORD INCIDENT, by Mark Rascovich published in Canada by McClelland and Stewart Limited, 25 Hollinger Road, Toronto 16; 337 pages; \$6.95.

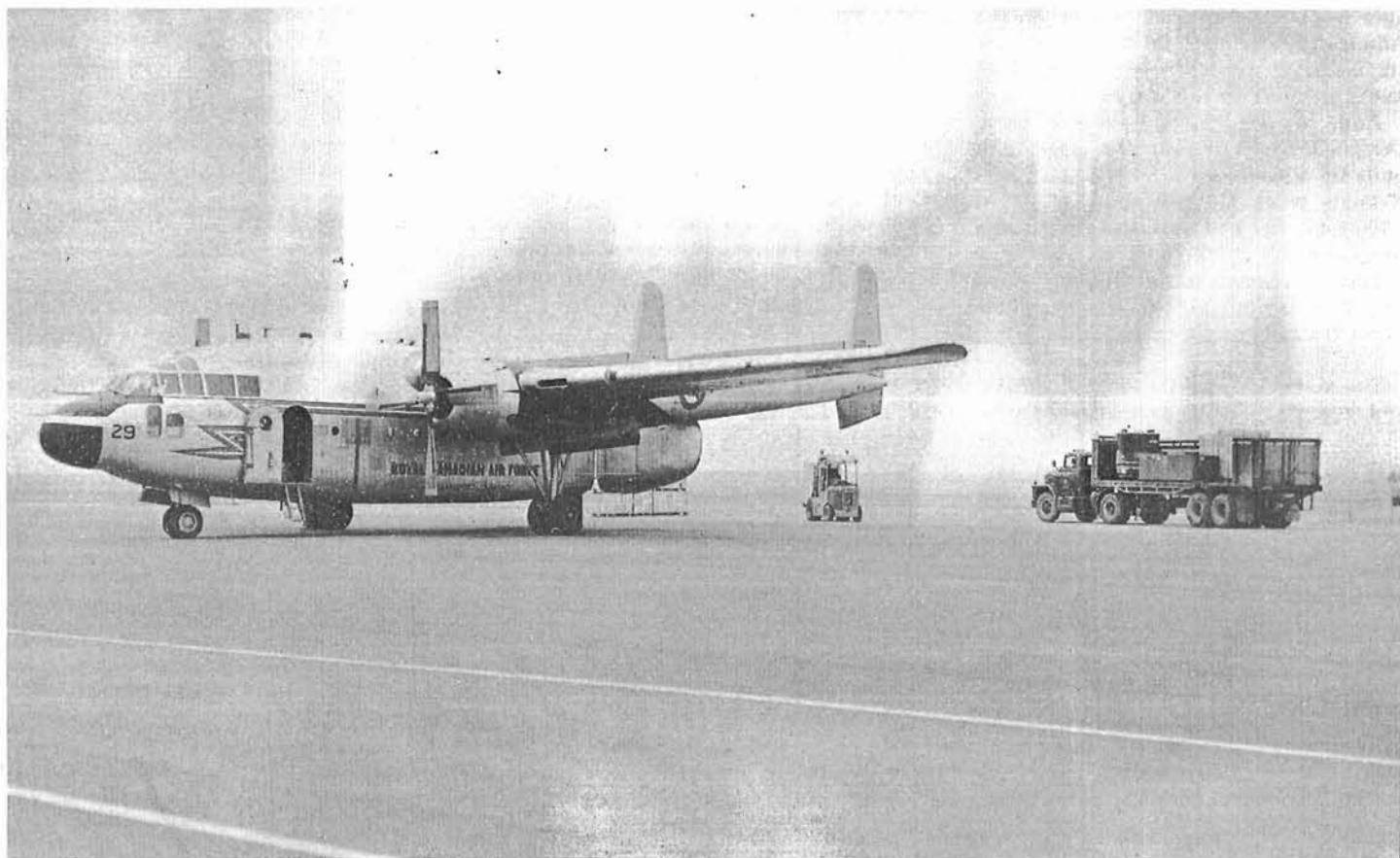

To speed movement of naval material between Montreal and Halifax a twice-a-week air cargo service, using RCAF C119 "Flying Boxcars", has been instituted, with the Naval Supply Depot, Montreal, co-ordinating ships into and out of Montreal and the Aviation Supply Depot, Dartmouth, looking after the eastern end of the route. On arrival of the first shipment at Shearwater in June, the aircraft was unloaded and reloaded in 25 minutes. Normal turnaround time is an hour. (DNS-31159)

Trade Group Not Bar To Promotion

MEN WHO ARE qualified for promotion in all respects other than being advanced in trade group will now find it possible to enter the promotion zone and compete for promotion, it was announced by Naval Headquarters in a general message (CANGEN 82) on May 1.

The earliest dates men affected by this change may enter the promotion zone are, for chief petty officers, second class, and petty officers, first and second class, June 1, 1963, for leading and able seamen, September 1, 1963.

The dates coincide with the date of the first promotion competition for the ranks concerned after the change. Men entering the promotion zone under these conditions will be considered in these and subsequent promotion competitions.

The above initial dates were selected to eliminate the reviewing of past promotion competitions for men who would have entered the promotion zone at earlier dates if no time limit were imposed. It must be appreciated that the number of men appearing on any promotion list is limited by strict rank ceilings and promotions are always made to the maximum allowable under current ceilings.

It is possible that a review of past lists would show that some men now being entered into the promotion zone under these conditions were eligible for promotion at an earlier date. The only way in which a promotion could be made in these circumstances would be by withdrawing a promotion already in effect or promoting above the authorized ceiling. Either action would create problems.

After the initial dates given above are past, the date of entry into the zone shall be the actual date that a man meets all requirements for promotion except that he has not been advanced in trade group.

All men entering the promotion zone under the condition that they are fully qualified with the above exception, will compete on an equal basis with men already in the zone even though they may have a lower trade group than these men.

When the new trade structure was introduced on January 1, 1960, the trade requirements became Trade Group IV

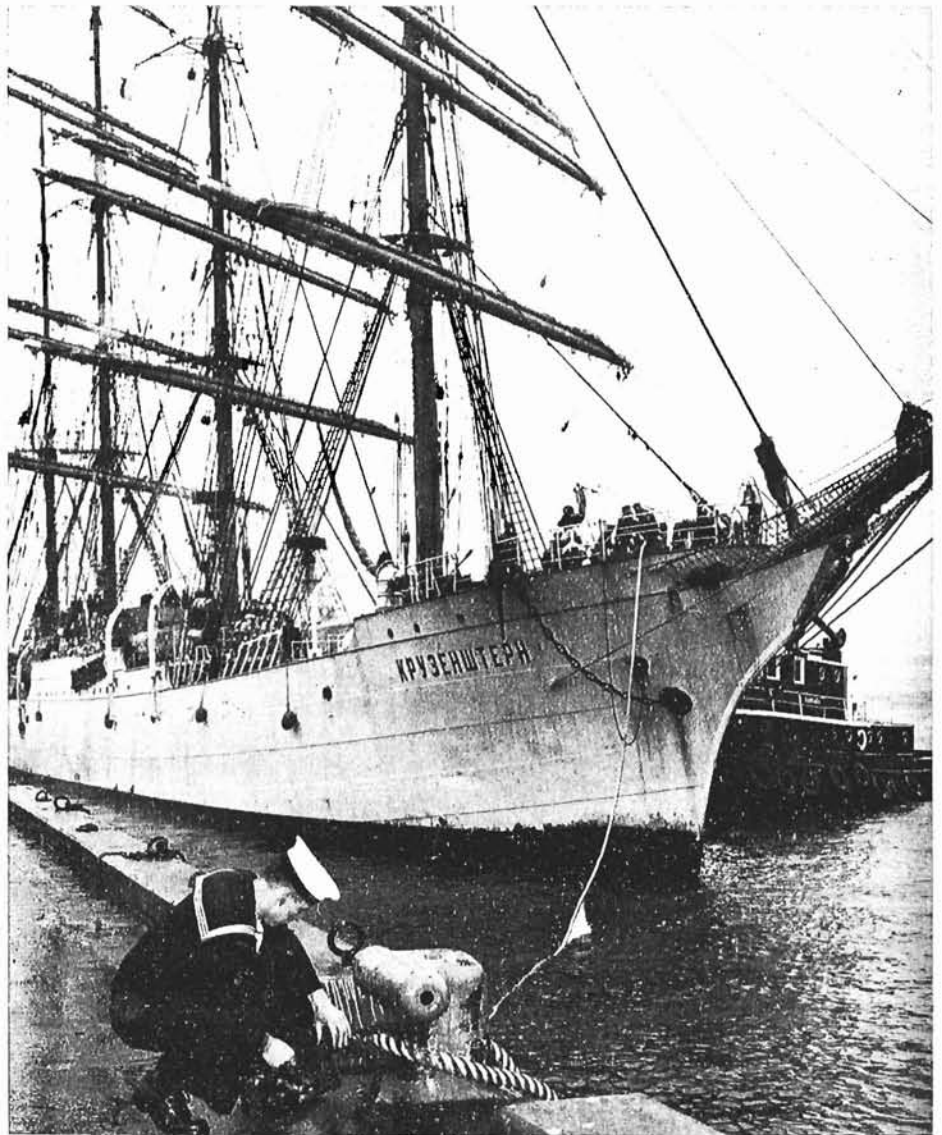

The four-masted Soviet sailing ship Kruzenshtern is eased into her berth at Halifax. The former German ship Padua, the Kruzenshtern was one of three Soviet ships which visited Halifax in April.

for chief petty officer, first and second class, and petty officer, first class; Trade Group III, for petty officer second class; Trade Group II for leading seaman, and Trade Group I for able seaman. All branches, except the electrical and ordnance branches, varied in their requirement before this new trade group standard was set.

This and the fact that men fully qualified for promotion under the branch concept were entitled to enter the promotion zone on introduction of the new promotion system, in some cases with a lower trade group than that now required, explains why there are some men already in the promotion zone holding the lower trade group and not qualified in the higher trade group.

When men who have entered the promotion zone without being advanced in trade group are promoted before being

advanced to the higher trade group they will receive preference on the advancement rosters.

When a man is promoted he will be placed at the top of the advancement roster for his trade and trade group but after any other men who have already been promoted under similar circumstances and who have not yet been advanced.

Men who will now compete for promotion but have not been advanced in trade group will be treated as if they had entered the promotion zone in the normal way. They will be awarded points for "time in zone" from their initial date of entry into the promotion zone to the maximum of 40 points and will not be affected by the introduction of any new qualifications for promotion while they remain in the promotion zone.

THE FUNCTIONS OF HOCHELAGA

Sir:

In the article entitled, "The Fleet School" (April 1963, *The Crownsnest*), there appears the following sentence . . . "*Hochelaga*, despite its importance, can be dismissed here—this is where the non-technical people are trained, cooks, stewards and others on the supply side".

This sentence tends to give the impression that the writer of the article has only a rudimentary knowledge of *Hochelaga* activities, or made an unfortunate choice of words. I believe that the latter was the case.

However, to avoid any misunderstanding which may arise from the quotation I should like to clarify *Hochelaga's* position.

First, in a discussion of Fleet Schools, I suggest that *Hochelaga* cannot be dismissed. The School is not "The Supply School", although it certainly started out that way and we on the staff are proud of it. However we are equally proud of being, in every sense of the word, a Fleet School and an integral part of the "Fleet School concept".

Second, there is some doubt that the "supply" people trained in *Hochelaga* are non-technical. *Hochelaga* doesn't think so, and Treasury Board when authorizing trades pay doesn't think so either. It cannot be denied that materiel management is an increasingly technical field and certainly more scientific than the traditional manual trades. Cookery is also technical, although the application and development of artistic flair is an essential part of that trade.

Third, *Hochelaga* is not just the place ". . . where the non-technical people are trained, cooks, stewards and others on the supply side".

There are four training divisions here, but only two deal with supply.

All "in-service" management training for the RCN is conducted in *Hochelaga*. Courses are given to commanders and to equivalent ranks in the Air Force, Army and Civil Service, and similarly to lieutenant-commanders, and commissioned officers and chief petty officers. There are also plans under way to broaden this coverage. This subject is

not technical, but neither can it be painted white and called supply.

The remaining division speaks the English language and gives basic training to French-speaking recruits. True, this is non-technical—also—it is non-supply. However it is integrated with the new entry training in *Cornwallis*.

While we are on the subject of the April 1963 issue, may I also draw to your attention the article on page 13 titled "Management Engineering"? The management training performed in HMCS *Hochelaga* Fleet School has nothing to do with Management Engineering and we are not engaged in training in that field. I hate to be repetitive but the caption under the photograph refers to the ". . . RCN's Naval Supply School". We all know now that there isn't one, don't we?

W. F. JONES
Lieutenant-Commander
Training Officer

HMCS *Hochelaga*,
557 Dollard Street,
La Salle, P.Q.

- - AND A MYSTERY EXPLAINED

Sir:

With reference to the article "Mystery of the Branch Badges" on page 23 of the April issue, I would like to point out the significance of the "Branch Badge" which is no mystery to practising shipwrights.

The working tools of the badge are commonly known and referred to in the craft as the "Beadle and Hawsing Iron".

The "Beadle", (biddle or wooden maul), made of lignum vitae, ironbark, jara or greenheart, was ferruled with seamless iron rings to prevent splitting of the wood and the size of the rings depended on the required weight of the beadle. The helve was round and

tapered at the beadle end, the length equalling that from the cupped hand to the oxtar (armpit).

The "Hawsing Iron", (in some places called housing, horsing or beetling iron), was little more than a double-grooved caulking iron with a handle, the purpose of which was to drive hard the "making up", (made-up threads of oakum in the seam prior to being pitched).

The design of such a badge to represent the craft no doubt stemmed from the most common sight in ship maintenance in those days, when the ship was beached for scraping and pitching, a crew of caulkers may have been seen "drumming" areas of the underwater

hull to beat the tide under the direction of the ship's carpenter. "Drumming" was a term meaning to harden up the threads which had worked loose between maintenance periods and did not require re-caulking.

The description, "Beadle and Hawsing Iron has been passed on and accepted generally here on the West Coast by naval shipwrights since approximately 1901 and, as well, is accepted in the United Kingdom.

Yours truly,
A. E. DEANS, C2HT4
(Shipwright Journeyman)

1233 Effingham St.,
Esquimalt, B.C.

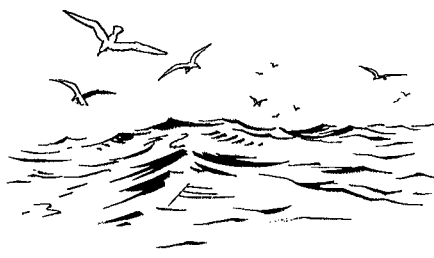

RETIREMENTS

PO ROBERT WARD BARRIE, CD, P1ER4; served in RCNVR January 29, 1943, to November 8, 1945; joined RCN March 11, 1946; served in *Star*, *Cornwallis*, *Stadacona*, *Digby*, *York*, *Brantford*, *Peregrine*, *Avalon*, *Micmac*, *Scottian*, *Nootka*, *La Hullose*, *Haida*, *New Liskeard*, *Magnificent*, *Trinity*, *Fundy*, *Cormorant*, *Porte St. Jean*, *Granby*; retired June 16, 1963.

CPO ROBERT STANLEY BUSSEY, C1BN4; joined June 6, 1938; served in *Naden*, *St. Laurent*, *Stadacona*, *Sherbrooke*, *Avalon*, *La Malbate*, *Antigonish*, *Cayuga*, *Chippawa*, *Stettler*, *Oriole*, *Crescent*, *Assiniboine*, *Malahat*; awarded RCN Long Service and Good Conduct Medal; retired June 5, 1963.

CPO JOHN ROBERT JAMES CLELAND, CD, C2ER4; joined June 11, 1938; served in *Stadacona*, *Venture*, *Skeena*, *Niobe*, *Malpeque*, *Goderich*, *Fredericton*, *Avalon*, *Ottawa*, *Niobe*, *Prince Henry*, *Peregrine*, *Westmount*, *Bowmanville*, *New Liskeard*, *Scotian*, *Hunter*, *Iroquois*, *Portage*, *Magnificent*, *La Hullose*, *Haida*, *Huron*, *Crescent*, *Quebec*, *Micmac*, *Penetang*, *Labrador*, *Buckingham*, *Cape Scott*, *Cataragui*, *Bytown*; retired June 10, 1963.

CPO ALECK CHARLES CRAFT, C1ER4; joined June 9, 1938; served in *Naden*, *Nootka*, *Ottawa*, *Stadacona*; *Niagara*, *Givenchy*, *New Glasgow*, *Gatineau*, *Sioux*, *Uganda*, *Ontario*, *Cayuga*, *Athabaskan*, *Tecumseh*, *Discovery*; awarded Long Service and Good Conduct Medal; retired June 9, 1963.

CPO LAWRENCE HARRIS FARR, CD, C2WS4; joined June 2, 1941; served in *Naden*, *Prince Robert*, *Cornwallis*, *Stadacona*, *Niagara*, *Givenchy*, *ML-068*, *Prince Rupert*, *Avalon*, *Jonquiere*, *Diving Tender 3*, *Diving Tender 2*, *Warrior Rockcliffe*, *Ontario*, *Sioux*, *Venture*,

Niobe, *HMS Excellent*, *Athabaskan*, *Saguenay*, *Griffon*, *Patriot*, *Chippawa*; retired June 1, 1963.

PO MAXWELL CLARK GUTHRIE, CD, P1BN4 joined June 6, 1938; served in *Naden*, *St. Laurent*, *Stadacona*, *Assiniboine*, *Givenchy*, *Prince David*, *Prince Henry*, *Prince Robert*, *Cornwallis*, *Uganda*, *Rockcliffe*, *Antigonish*, *Unicorn*, *Cedarwood*, *Niobe*, *HMS Dolphin*, *HMS Terror*, *Quadra*, *Stettler*; retired June 5, 1963.

CPO RUSSEL NOEL KNIGHT, C2WS4; joined June 10, 1938; served in *Naden*, *Restigouche*, *Stadacona*, *HMS Victory*, *HMS Excellent*, *Skeena*, *Cornwallis*, *Niobe*, *Athabaskan*, *Peregrine*, *Donnacona*, *Givenchy*, *Rockcliffe*, *Ontario*, *Cayuga*, *Jonquiere*, *Royal Roads*; retired June 9, 1963.

CPO WILLIAM EDGAR LYON, CD, C2HT4; joined RCNVR August 7, 1942, transferred to RCN September 23, 1945; served in *Stadacona*, *Scotian*, *Iroquois*, *Magnificent*, *Wallaceburg*, *Montcalm*, *Bonaventure*; retired June 20, 1963.

CPO LAWRENCE PHILLIP McRAE, CD and 1st Clasp, C2BN4; joined June 6, 1938; served in *Stadacona*, *Venture*, *Skeena*, *St. Laurent*, *Cornwallis*, *Niobe*, *HMS Excellent*, *Haida*, *Peregrine*, *Warrior*, *RNAS Dartmouth*, *Iroquois*, *Portage*, *Nootka*, *Donnacona*, *Micmac*, *Porte St. Jean*, *Thunder*, *Huron*, *Shearwater*, *Quinte*, *Bonaventure*; retired June 5, 1963.

CPO SAMUEL RUTHERFORD MILLER, C11RS4; joined June 6, 1938; served in *Naden*, *Restigouche*, *Bytown*, *HMC Sig School*, *St. Hyacinthe*, *Bytown*, *Venture*, *St. Francis*,

Stadacona, *Givenchy*, *Burrard*, *Coverdale*, *Cornwallis*, *Gloucester*, *Naval Radio Station Gander*, *NRS Frobisher*; awarded RCN Long Service and Good Conduct Medal; retired June 5, 1963.

PO CARL EDWARD MOENCH, CD, P1CM4; served in RCNVR December 13, 1941 to November 8, 1945; joined RCN April 21, 1942; served in *Queen*, *Chippawa*, *Naden*, *Timmins*, *Stadacona*, *ML-118*, *Venture*, *ML-057*, *Peregrine* *ML-105*, *Capitano*, *Peregrine*, *Antigonish*, *Athabaskan*, *Sioux*, *Star*, *Cornwallis*, *Hochelaga*, *New Glasgow*, *Tecumseh*, *MacKenzie*; retired June 26, 1963.

CPO JAMES ALEXANDER RUSSELL, CD, C2ETA; joined June 6, 1938; served in *Stadacona*, *Venture*, *Saguenay*, *Trillium*, *Annapolis*, *Cornwallis*, *Niobe*, *Saskatchewan*, *White-throat*, *Scotian*, *Nootka*, *La Hullose*, *Haida*, *New Liskeard*, *Thunder*, *Resolute*, *Star*, *Patriot*, *Bonaventure*, *Bytown*; retired June 5, 1963.

PO ROSS MEREDITH STEENE, CD, P1AM2; joined RCNVR June 11, 1942, transferred to RCN May 1, 1944; served in *Bytown*, *York*, *Cornwallis*, *HMS Baffin*, *Stadacona*, *Norunda*, *Fort Ramsay*, *Scotian*, *Stonetown*, *Avalon*, *Riverton*, *Diving Tender 3*, *Iroquois*, *RCNAS Dartmouth*, *Warrior*, *Magnificent*, *Shearwater* (VF870), *Bonaventure*; retired June 14, 1963.

CPO ANGUS THENDERSON WELSH, C1BN4; joined June 6, 1938; served in *Naden*, *Fraser*, *Stadacona*, *Assiniboine*, *Hepatica*, *Niobe*, *Ontario*, *Magnificent*, *Quebec*, *Niobe II*, *Bonaventure*; awarded RCN Long Service and Good Conduct Medal; retired June 5, 1963.

OFFICERS RETIRE

CDR. HAROLD ALBERT BLACK, CD; joined RCNR on June 22, 1938; transferred to RCN October 24, 1945, as a paymaster sub-lieutenant; served in *Stadacona*, *Venture*, *Protector*, *Chaleur*, *Avalon*, *Cornwallis*, *Bytown*, *Uganda*, *Ontario*, *Naden*, *Rockcliffe*, *Niobe*, *Niagara*; last appointment *Niagara*, on attachment to Supreme Allied Commander Atlantic as Training Officer Exercises; commenced retirement leave on July 1, 1963; retires January 24, 1964.

CD. OFF. FRANK EDWARD WILLIAM DENNIS, CD; transferred to RCN from Royal Navy on August 1, 1936, as a Stoker 2nd Class; promoted to acting commissioned writer officer on November 15, 1951; served in *Magnificent*, *Cornwallis*, *Stadacona*, *Shearwater*, *Naden*, *Saguenay*, *Champlain*, *St. Laurent*, *Skeena*, *HMS Dominion*, *Niobe*, *Venture*, *St. Hyacinthe*, *Peregrine*; last appointment *Naden*, as Commodore's Secretary; commenced retirement leave on July 15, 1963; retires on February 23, 1964.

CDR. HUBERT JAMES HUNTER, CD; joined RCNVR on October 6, 1939; transferred to the RCN March 17, 1940, as an ordinary

seaman; promoted to sub-lieutenant on May 1, 1941; served in *Naden*, *St. Laurent*, *Royal Roads*, *Stadacona*, *Kings*, *HMS Merlin*, *HMS Daedalus*, *HMS Jackdaw*, *HMS Heron*, *HMS Sparrowhawk*, *HMS Blackcap*, *HMS Vulture*, *Niobe*, *Naval Headquarters*, *Warrior*, *Magnificent*, *Shearwater*, *Micmac*, *Niagara*, *Bonaventure*, *Resolute*, *Chaleur*; last appointment *Naval Headquarters* on staff of Director Naval Operational Requirements as Assistant Director Naval Operations; commenced retirement leave on May 20, 1963; retires on December 13, 1963.

LT-CDR. JAMES CLARENCE MARK, CD; joined RCNVR January 1, 1942, as a sub-lieutenant (SB); transferred to RCN June 6, 1946; served in *Prevost*, *Naden*, *Prince Henry*, *Kings*, *Dawson*, *Cornwallis*, *St. Hyacinthe*, *Uganda*, *Bytown*, *Magnificent*, *Shearwater*, *Stadacona*; last appointment *Stadacona* as OIC Naval Examination Centre; commenced retirement leave May 19, 1963; retires November 21, 1963.

CDR. WILLIAM JAMES MARSHALL, OBE, CD; joined RCNR February 28, 1939; transferred to the RCN May 9, 1946, as probation-

ary paymaster sub-lieutenant; served in *HMS Drake*, *HMS Cochrane*, *Dominion*, *Stadacona*, *Niobe*, *St. Hyacinthe*, *Protector*, *Scotian*, *Magnificent*, *Naval Headquarters*, *Niagara*, *Donnacona*, *Hochelaga*, *Shearwater*, *Naden*; last appointment *Naden* as Supply Officer, commenced leave on June 30, 1963; retires on January 23, 1964.

CDR. HAROLD DUNCAN McCORMICK, CD; joined RCNVR February 26, 1941; transferred to the RCN November 30, 1945, as a sub-lieutenant (SB); served in *Stadacona*, *HMS Victory*, *HMS Manchester*, *HMS Mercury*, *HMS Renown*, *HMS Collingwood*, *HMS Warren*, *Naval Headquarters*, *Niobe*, *Ontario*, *Naden*, *Bytown*; last appointment *Bytown*, on staff of Director Naval Programme Control as Deputy Director Naval Program Control (Major Equipment); commenced leave on July 1, 1963; retires on January 10, 1964.

LT-CDR. DAVID RENNIE MOREIRA; joined RCN(R) on November 14, 1949, as an ordinary seaman; transferred to the Royal Canadian Navy September 12, 1961, as an ordnance cadet on March 1950; served in

Cabot, Stadacona, la Hullose, Scotian, Niagara, Bytown, Bonaventure, Hochelaga; last appointment Bytown on staff of Assistant Director Ship Design and commenced leave on July 9, 1963; retired on July 16, 1963.

LT.-CDR. NORMAN CHRISTOPHER PENNEY, CD; joined RCNVR October 11, 1939; demobilized December 20, 1945; transferred to the RCN May 15, 1953, as an Ordinary Seaman; promoted to probationary sub-lieutenant, August 10, 1942; served in Stadacona, Camrose, Chaleur, Avalon, Stadacona, Klugs, HMS Baffin, Niobe, HMS Pembroke, Bytown, York, Carleton, Gloucester, Cornwallis, Hochelaga, Coverdale, Hunter; last appointment Hunter, as Staff Officer Administration and as Supply Officer; commenced leave on July 14, 1963; retires on October 15, 1963.

LT. PATRICIA ROSEMARY RENNIE; joined RCN(R) September 10, 1951; trans-

ferred to RCN on June 13, 1955 as an ordinary wren; promoted to acting sub-lieutenant (W) on February 19, 1953; served in Malahat, Cornwallis, Coverdale, Churchill, Shearwater, Bytown, Patriot; last appointment Bytown, on staff of Staff Office (Wrens) as Assistant Staff Officer (Wrens); Commenced leave on June 19, 1963; retires on September 30, 1963.

LT.-CDR. DAVID EDWARD RIGG, CD.; joined RCN February 16, 1931 as Boy Seaman; promoted to acting gunner (T) on February 7, 1942; served in Naden, HMS Venon, HMS Hood, Vancouver, Fraser, Ottawa, Stadacona, Niobe, Skeena, Sioux, Bytown, Crescent, Brunswicker, Malahat, Cedarwood, Oshawa, Queen; last appointment Malahat as Staff Officer Administration; commenced leave on June 2, 1963; retires on February 17, 1964.

LT.-CDR NORMAN STEWARDSON, CD; joined RCNVR April 5, 1942, demobilized May

22, 1946; entered the RCN(R) December 28, 1946; transferred to the RCN August 3, 1949 as a stoker I; promoted to warrant officer (SB) on March 15, 1945; served in Naden, Givenchy, St. Hyacinthe, Discovery, Malahat, Bytown, Stadacona, Cornwallis, Bytown; last appointment Naden, on staff of Flag Officer Pacific Coast, as Area Naval Fire Chief and on staff of Commodore Superintendent Pacific Coast as Base Fire Chief; commenced leave on June 16, 1963; retires on October 11, 1963.

CDR. FRANCIS SHEPARD WARD; joined RCNVR March 7, 1945; transferred to the RCN July 11, 1946 as a probationary sub-lieutenant (SB) (E); served in Donnacona, Scotian, Niobe, Bytown, Ontario, Niagara, Hochelaga; last appointment Hochelaga, as Principal Naval Ordnance Overseer Quebec Area and as Superintendent Naval Armament Depot Longueuil; commenced leave on July 8, 1963; retires on November 25, 1963.

ADMIRAL'S ANNUAL INSPECTION.

REMINDEERS

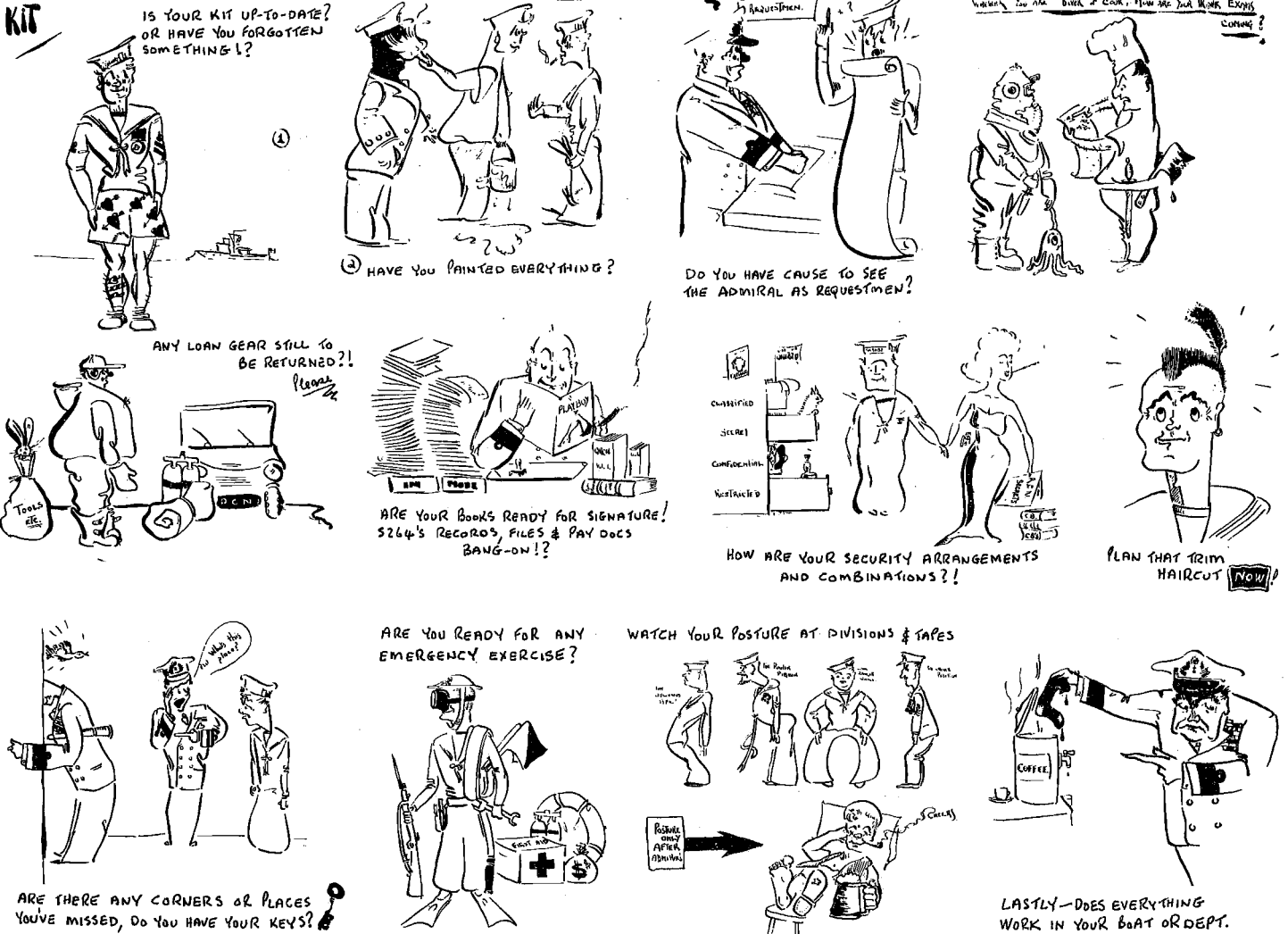

It's the XO who sooner or later takes the rap if things are not top line for the Admiral's inspection, so Lt. Alan Sagar, executive officer of HMCS Granby, the clearance diving depot ship, offered a few visual reminders to all hands before the big day, knowing full well that sailors tend to ignore the usual unfriendly notice board admonitions.

Naval Lore Corner

Number 118 THE HARDY "HUNTS"

86 OF THESE HANDY LITTLE WARTIME-CONSTRUCTED VESSELS WERE BUILT BETWEEN 1939 AND 1941. DESIGNED AS ESCORT-DESTROYERS, THEY WERE DIVIDED INTO FOUR TYPES. THEY SAW ACTION FROM THE ARCTIC TO THE MEDITERRANEAN AND 18 WERE LOST DUE TO ENEMY ACTION. UNITS OF THIS CLASS ARE STILL FOUND IN MANY OF THE WORLD'S SMALLER NAVIES...

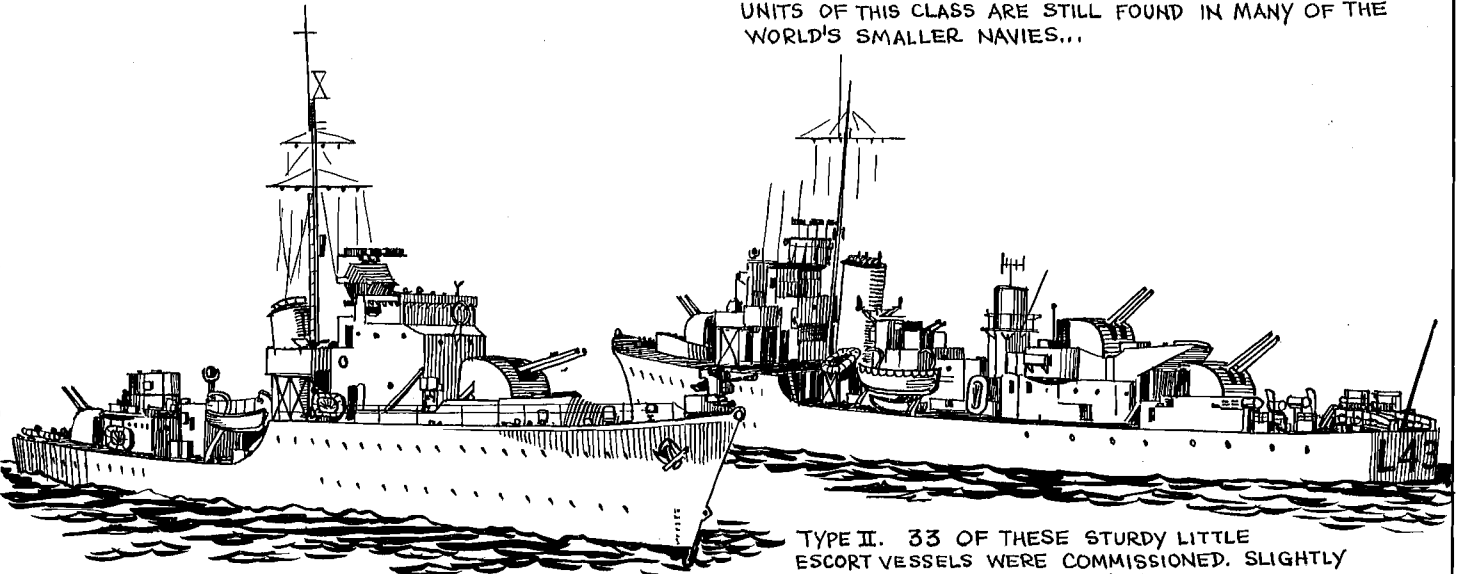

TYPE I. TWENTY OF THESE 1000-TON SHIPS WERE BUILT. THEY CARRIED FOUR 4-INCH GUNS AT 27.5 KNOTS. THEIR ENDURANCE WAS LIMITED FOR FLEET WORK...

TYPE II. 33 OF THESE STURDY LITTLE ESCORT VESSELS WERE COMMISSIONED. SLIGHTLY HEAVIER THAN THE 'TYPE I's', THEY WERE ARMED WITH SIX 4-INCH GUNS. HIGHLY MANOEUVRABLE, THEY WERE MAGNIFICENT A/S AND A.A. VESSELS...

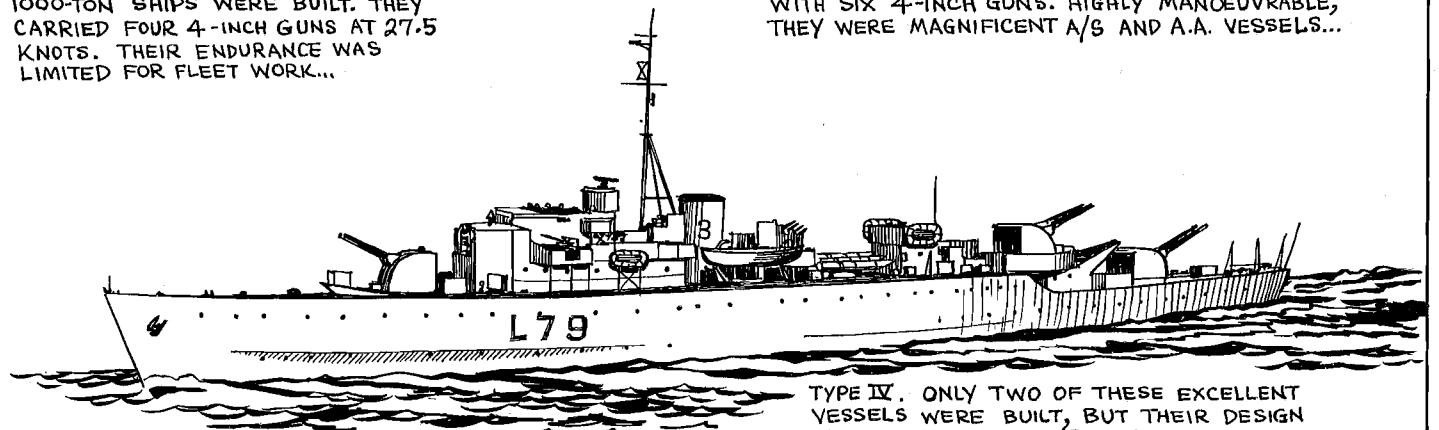

THE TYPE III's (BELOW) MOUNTED 2 TORPEDO TUBES IN ADDITION TO THEIR FOUR 4-INCH GUNS, GIVING THEM AN OFFENSIVE CAPABILITY AND QUALIFYING THEM AS TRUE DESTROYERS...

TYPE IV. ONLY TWO OF THESE EXCELLENT VESSELS WERE BUILT, BUT THEIR DESIGN INFLUENCED FUTURE BRITISH FRIGATE DESIGN. GOOD SEA-BOATS. THEIR STRUCTURAL STRENGTH AND ACCOMMODATION WAS A VAST IMPROVEMENT. THEY MOUNTED SIX 4-INCH GUNS AND 3 TORPEDO TUBES. ALL THE "HUNT" CLASS WERE RE-CLASSIFIED AS FRIGATES IN 1947...

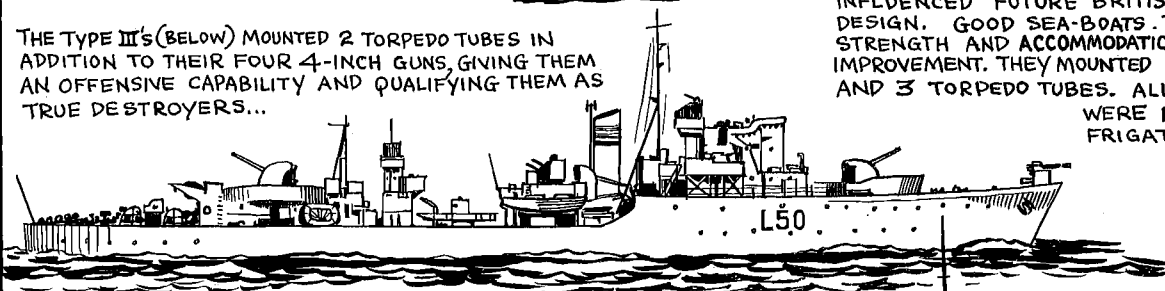

HMS BROCKLESBY (TYPE I, RIGHT) IS THE SOLE SURVIVOR STILL IN COMMISSION IN THE ROYAL NAVY (1963). SHE IS EMPLOYED AS A SONAR TRIALS SHIP AND IS UNARMED...

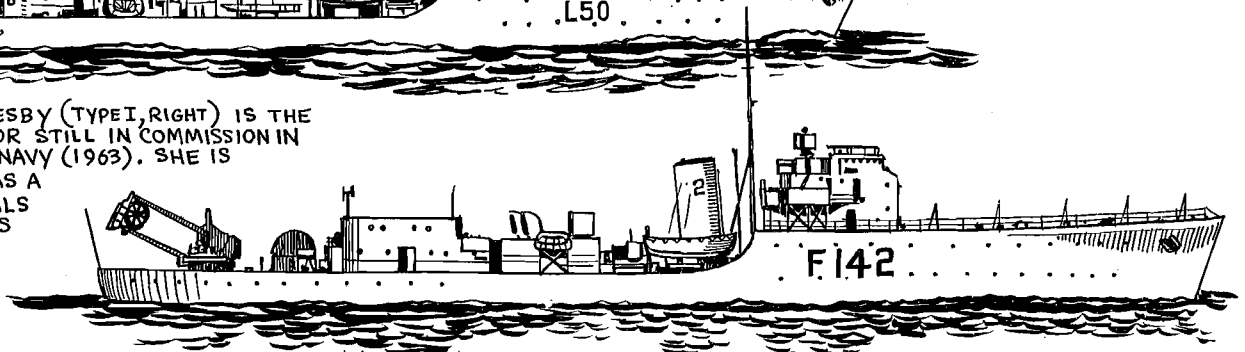

Roger Duhamel

QUEEN'S PRINTER - IMPRIMEUR DE LA REINE

MR. E. S. DIXON,
CONT. OF OFFICES SERV. &
SUPPLIES, DEPT. OF NAT'L
DEFENCE, 125 ELGIN ST.,
OTTAWA, ONT. CRO.F.

If undelivered return to:

The Queen's Printer, Ottawa, Canada

En cas de non-livraison, retourner à:

L'Imprimeur de la Reine, Ottawa, Canada



The CROWSNEST



NATIONAL DEFENSE
RECEIVED
C-2
AUG 2 1963
LIBRARY

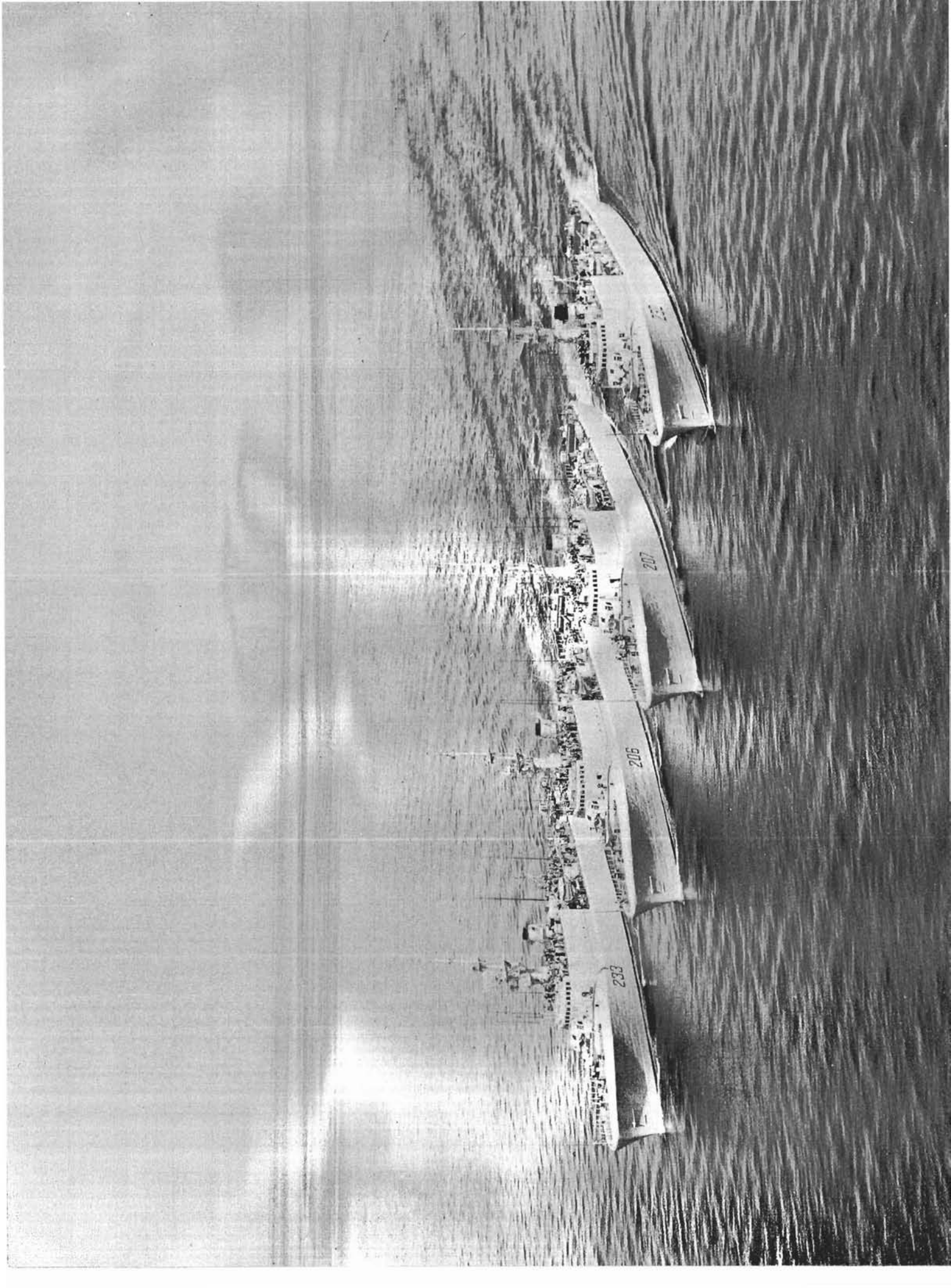

The CROWSNEST

Vol. 15 No. 8

THE ROYAL CANADIAN NAVY'S MAGAZINE

AUGUST 1963

CONTENTS

	Page
<i>The State of the RCN</i>	2
<i>RCN News Review</i>	13
<i>The Last Days of Sail</i>	15
<i>Here and There in the RCN</i>	18
<i>Home from the Sea</i>	19
<i>The RCN's Plot</i>	20
<i>Afloat and Ashore</i>	21
<i>Swift but not Sure</i>	23
<i>Books for the Sailor</i>	25
<i>Memorial to 'Maggie'</i>	26
<i>The New Pay Schedules</i>	27
<i>Retirements</i>	28
<i>Naval Lore Corner No. 119</i>	<i>Inside Back Cover</i>

LADY OF THE MONTH

It takes remarkably good seamanship to carry out an evolution like the multiple jackstay transfer depicted on the opposite page—even in waters as calm as those so often found in the vicinity of Victoria.

The destroyer escort at the right of the picture is HMCS *Margaree* and to her starboard, in order, are the *Skeena*, *Saguenay* and *Fraser*. (E-72168)

Because of the space devoted in this issue to the evidence of the Chief of the Naval Staff before the special committee on defence some of the regular departments are omitted.

Negative numbers of RCN photographs reproduced in *The Crowsnest* are included with the caption for the benefit of persons wishing to obtain prints of the photos.

This they may do by sending an order to the Naval Secretary, Naval Headquarters, Ottawa, attention Directorate of Naval Photography, quoting the negative number of the photograph, giving the size and finish required, and enclosing a money order for the full amount, payable to the Receiver General of Canada.

Sizes, finish and the National Defence standardized prices, follow:

4 x 5 (or smaller) glossy finish only ..	\$.10
6½ x 8½ glossy finish only40
8 x 10 glossy or matte finish50
11 x 14 matte finish only	1.00
16 x 20 " " "	3.00
20 x 24 " " "	4.00
30 x 40 " " "	8.00

SUBSCRIPTION RATE

The Crowsnest may be subscribed for at the rate of \$2 a year; outside of North America, \$3. Orders, accompanied by cheque or money order payable to the Receiver General of Canada, should be sent to:

THE QUEEN'S PRINTER,
Department of Public Printing
and Stationery,
OTTAWA, Ontario

Communications, other than those relating to subscriptions, should be addressed to:

EDITOR,
The Crowsnest,
Naval Headquarters,
OTTAWA, Ontario.

The Cover—It has become an established tradition for the Royal Canadian Navy to present the famous Sunset Ceremony on Parliament Hill in Ottawa on Canada's birthday, July 1. This picture was taken as this year's presentation of the ceremony was about to begin. (0-15062)

THE STATE OF THE RCN

Its Task, Its Resources, Its Future

On the morning of Tuesday, July 9, 1963, Vice-Admiral H. S. Rayner, Chief of the Naval Staff, appeared before the House of Commons special committee on defence, under the chairmanship of Maurice Sauvé, MP. Admiral Rayner's presentation, which was accompanied by slides,

gave a comprehensive picture of the Royal Canadian Navy of today and its plans for the future. The text of Admiral Rayner's evidence, as it appears here, has been modified only slightly to conform to the magazine's style.

MR. CHAIRMAN, members of the committee, it is a great privilege for me to appear before you and discuss with you some matters of particular interest underlying the purpose and tasks of the Navy, the RCN as it is today, including current ship construction programs, the strength of the Navy, and naval expenditures in recent years.

Threat

To view the RCN requirements in perspective, it is essential to have a good understanding of the maritime threat which has to be countered.

I will review this briefly for you under three main aspects any of which could affect possible RCN operations and, therefore, the forces we should have. These are:

1. Soviet submarine force—the dominant maritime threat,
2. Soviet long range aviation as a maritime threat; and
3. Soviet fishing fleet activities in the Western Atlantic.

Soviet Submarine Force

Russia has and is continuing to build and modernize the largest submarine fleet the world has ever seen.

It has a capability of:—

- (a) Missile attack,
- (b) Torpedo attack,
- (c) Mine laying.

This fleet is estimated to include over 400 submarines of which over 20 are nuclear-powered. It is anticipated that as the numbers of nuclear boats increase, the numbers of conventional submarines will decrease over the next few years. Also it follows that increased numbers of nuclear submarines will greatly increase the power of the Russian submarine force.

Soviet Long-Range Air Threat

On Tuesday, June 4, 1963, six Russian jet bombers flew a reconnaissance mission over a USN task force northeast of Japan. This is an example of Russian long-range aircraft being employed on distant overseas reconnaissance. These forays have taken place far out into the Atlantic as well as in the Pacific, thus demonstrating that these aircraft have the range and capability of operating over the greater part of these oceans. Such aircraft are equipped with stand-off weapons which could be used against any maritime forces.

Soviet Fishing Fleet

Russia operates a very large and well-disciplined fishing fleet off the East Coast of Canada. In 1962 there were about 550 trawlers and supply vessels at the peak of the fishing season. The numbers have varied from year to year and during the course of the year. The presence of a force of this size, in modern well found ships, must be considered a potential menace in time of crisis or hostilities.

Furthermore, some of these vessels are well equipped for the support or cover of a number of activities of a military nature. Their very physical presence would greatly hinder anti-submarine operations.

Those then are the main aspects of the maritime threat against which the Canadian naval plans and programs should be viewed.

In recent years there has been much evidence that the Soviet Union has become keenly aware of the maritime nature of global geography. Historically content to think and act primarily as a land power, within the confines of Europe and Asia, Russia today is reaching out over the oceans. It is abundantly clear that the USSR has recognized the economic and political importance of the oceans.

You will recall that last year the Soviet Union attempted to establish a missile base in Cuba. However, before her preparations could be completed, a naval quarantine was imposed by the United States. Russian ships, laden with strategic weapons and materials, were forced to alter course and not proceed to their destination. Once again it was clearly shown that prior to establishing a military base overseas, it is essential to be assured of the unrestricted use of the seas.

The Soviets have also been concentrating on their merchant marine which in the last decade has doubled in tonnage and now totals 4,000,000 tons. There are indications that they plan to triple this tonnage by 1967. Their efforts in oceanographic research have accelerated in an ever widening geographic coverage. Three of their ships were in Halifax in late April to replenish prior to returning to their work in the Gulf Stream a few hundred miles south of Nova Scotia.

To give you a general idea of the comparison between the water and land masses which cover the earth, it is of interest to note that the high seas cover approximately 140 million square miles in contrast to about 52 million square miles occupied by land areas and inland waters. In other words, 70 per cent of the earth's surface is water.

Plying the trade routes of the world on any given day, there are about 18,000 ships of over 1,000 tons at sea, while another 11,000 are in harbours around the world. During 1962, 141,183 vessels engaged in international or coastwise shipping arrived at Canadian ports and loaded or unloaded approximately 102 million tons of international cargo.

VOTE OF APPRECIATION

At the 17th annual general meeting of the Naval Officers' Associations of Canada, June 6-8, in London, Ontario, the following resolution was passed:

"WHEREAS The Naval Officers' Associations of Canada are aware of the high state of efficiency which exists throughout the Fleet;

AND WHEREAS The Naval Officers' Associations of Canada appreciate the personal efforts being extended by all members of the RCN in carrying out their duties;

AND WHEREAS The Naval Officers' Associations of Canada are proud of the contribution being made by the RCN to the preservation of peace throughout the world;

NOW THEREFORE BE IT RESOLVED That a sincere expression of appreciation be forwarded to the Chief of the Naval Staff and through him to all personnel of the Royal Canadian Navy and the Royal Canadian Naval Reserve for their continuing efforts on behalf of the citizens of Canada in maintaining the fleet at a high state of excellence and their contribution to the keeping of the peace and the preservation of the Freedom of the Seas."

Another statistic which is of interest in illustrating our dependence on the sea is that 96 per cent of the world's principal cities and over 50 per cent of the world's population are located within 250 miles of the sea or on less than 5 per cent of the land mass.

We live close to the sea because the sea is important to us—for food, for commerce and transportation.

The Purpose of the RCN

HOW IMPORTANT is the sea to Canada? Our shores are washed by three oceans and our coast lines total 19,100 miles. This, together with our large overseas trade, makes the sea tremendously important to us.

In this connection I would like to quote from a pre-Confederation speech given by Thomas D'Arcy McGee in a New Brunswick town, in 1864:

"I rejoice, moreover, that we men of insular origin are about to recover one of our lost senses—the sense that comprehends the sea—that we are not about to subside into a character so foreign to all our antecedents, that of a mere inland people. The union of the provinces restores us to the ocean, takes us back to the Atlantic, and launches us once more on the modern Mediterranean, the true central sea of the western world."

Our geographical and political situation has inspired and encouraged a reasonably steady growth of the Navy over the years since it was first established in 1910, more or less keeping step with the expansion of the country.

I have been asked by all sorts of people from members of Parliament to Boy Scouts, what is the purpose of the Navy?

We define the purpose of the RCN—

"To ensure that Canada in co-operation with allied and friendly nations will have unrestricted use of the seas in peace and war."

Please note the words "in co-operation with allied and friendly nations".

The Role of the RCN

SOME FORM of collective security is essential for Canada. In thinking of the part or role that the Navy has to play we assume that, in time of emergency, in addition to operating with the Air Force and the Army, the RCN will also operate in conjunction with allied navies. In principle and in practice, this has already been well established by the setting up of integrated RCN-RCAF Maritime Commands at Halifax and Esquimalt and by frequent exercises with NATO maritime forces. It has been agreed that the role of the RCN is to support Canada's external policy and de-

fence policy through the provision of versatile naval forces.

These forces must have the capability to:

- (a) defend Canada's interests against attack from the sea;
- (b) meet Canada's commitments to collective security arrangements; e.g. to NATO and to Canada-US defence arrangements. We have agreed to provide to the Supreme Allied Commander, Atlantic, known as SACLANT, on an alert, one A/S carrier and 29 A/S escorts, and to the CAN-US region of NATO—14 A/S escorts and 10 minesweepers, for a total NATO commitment of one A/S carrier, 43 A/S escorts and 10 minesweepers. In view of the magnitude of the submarine threat it is clear that a strong integrated NATO A/S force is very definitely part of the overall deterrent;
- (c) contribute to other external undertakings, e.g. to UN operations (Korea and Suez);
- (d) support the Canadian Army in actions arising out of (b) and (c); and
- (e) contribute to the maintenance of Canadian sovereignty in the Arctic.

Operational Tasks of the RCN

ARISING from the role, the tasks of the RCN have been listed as:

- (a) to defend sea lines of communication through control, escort and convoy of shipping;
- (b) to detect, locate and destroy enemy submarines;
- (c) to contribute to early warning of attack launched from over, on or under the sea;
- (d) to patrol the coastal areas and approaches to Canadian waters;
- (e) to keep Canadian ports, anchorages and approaches free of mines;
- (f) to provide logistic support for the fleet both afloat and ashore;
- (g) to transport, land and support Canadian Army contingents as required;
- (h) to provide mobile command and base facilities for external undertakings;
- (i) to carry out and support operations in the Arctic.

In addition, the RCN must be ready to:

- (a) assist in survival operations—this is an additional task of the 21 Naval Divisions which are established across Canada;
- (b) assist in maritime search and rescue operations.

As regards the first task (a):

The principal threat to sea communications is the submarine and, as you know, the RCN has specialized in anti-submarine warfare ever since the advent of NATO.

Most of the foregoing tasks are wartime tasks. The principal employment of the fleet in peacetime is to prepare to carry out its mission in war or in an emergency. In line with Canada's increasing interests on virtually all continents, there arises the necessity for the Navy to be familiar with differing conditions around the world. This is mandatory if our ships are to be ready to undertake operational tasks, in any part of the world, including Army support operations. It is also clearly desirable that, in conjunction with sea training, the ships should be available, during visits to foreign ports, to assist the Department of External Affairs and the Department of Trade and Commerce in projecting abroad a sincere and well-rounded image of Canada. In this connection, the following are some of the visits carried out by Canadian ships from the East Coast during 1962; Kingston, Jamaica and Trinidad for Independence Day celebrations; Accra, Ghana, and Lagos, Nigeria, for Canadian trade fairs; Amsterdam, Rotterdam, Wilhelmshaven and Dublin. In the same year ships from the West Coast visited Singapore, Rangoon, Colombo, Trincomalee (Ceylon), Port Swettenham (Malaya), Bangkok, Hong Kong and Yokosuka (Japan) in conjunction with a Commonwealth naval exercise in the Indian Ocean.

Opportunities are welcomed to fit in visits to foreign countries with training cruises and exercises. We carry out most of our international exercises with NATO forces, but we also exercise with the United States Navy and the Royal Navy and also with other Commonwealth forces. Advantage was taken during the recent visit of French fleet units to exercise with the French ships off Nova Scotia in the middle of June.

The RCN Today

TO MEET the role and to carry out the tasks that I have listed, the RCN consists of one A/S aircraft carrier, 43 anti-submarine escorts, 10 minesweepers and a variety of support and auxiliary craft. These ships are based as follows:

On the East Coast we have:

- 1 aircraft carrier with a squadron of Tracker aircraft and a squadron of helicopters embarked
- 11 destroyer escorts of the St. Laurent, Restigouche and Mackenzie classes
- 8 Tribal class destroyer escorts
- 10 frigates
- 6 minesweepers

- 3 Royal Navy submarines on loan
- 1 fleet replenishment ship
- 1 maintenance repair ship
- 3 squadrons of aircraft shore-based at the Naval Air Station, Dartmouth

On the West Coast we have :

- 7 destroyer escorts of the St. Laurent and Mackenzie classes
- 7 frigates
- 4 minesweepers
- 1 submarine
- 1 maintenance repair ship
- 1 squadron of aircraft shore-based at Patricia Bay.

I would like to show you these various types of ships and aircraft by classes.



Figure 1: HMCS Bonaventure. (BN-3307)

First, the aircraft carrier, HMCS *Bonaventure*, a 20,000-ton ship, was commissioned in Belfast in 1957 and carries up to 18 CS2F or Tracker aircraft and up to six helicopters. Both types of aircraft are used in the anti-submarine warfare role. She is essentially an anti-submarine ship for use in hunter/killer or convoy

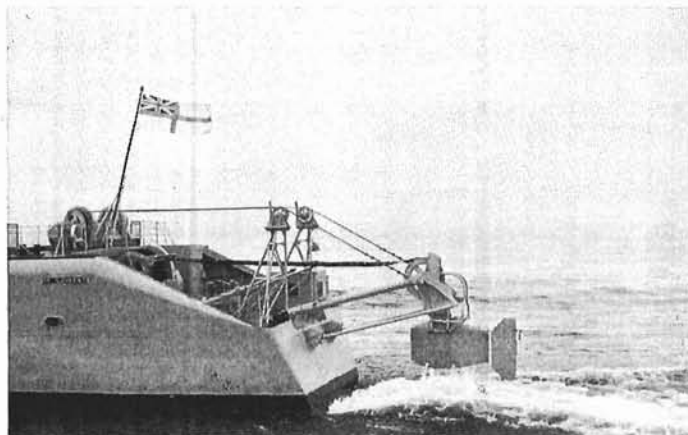

Figure 2: Variable depth sonar installation in HMCS St. Laurent. (E-65750)

defence operations. But she could be quickly converted for temporary use as an Army troop transport and support vessel. The *Bonaventure* is expected to remain in service until the mid 1970s.

You will recall that last September while the *Bonaventure* was on passage to European waters for a NATO exercise she played an important part in an air-sea rescue incident, when an American plane loaded with U.S. servicemen and their dependents went down in the Atlantic off Ireland.

Next we turn to the escorts. These can be divided into three main categories: the older type destroyers of Second World War vintage, such as the Tribal class; then the new types, the St. Laurent, Restigouche and Mackenzie class destroyer escorts, and lastly the frigates, smaller and slower, which, once again, are older wartime-built ships.

But, first, before showing you photographs of the escorts I would like to give you a brief explanation of the anti-submarine equipment and weapons used by ships.

The device used by ships for detecting, and tracking submarines up to the moment of attack is sonar, which is an abbreviation of the phrase "sound navigation and ranging". Sound waves from a transmitter in the bottom of the ship travel out in ever widening circles. When these waves strike an object such as a submarine an "echo" travels back to a receiver in the ship. Electronic devices compute the bearing and range of the object and display and record this information in the ship. A fire control computer calculates when the anti-submarine weapons should be fired and fires them.

Figures 2 and 3 show the variable depth sonar, or VDS, a Canadian development. With this device the sonar transmitter and receiver can be suspended hundreds of feet below the ship on a cable, well away from surface noises. The depth selected is that below the area where sudden temperature changes occur in the water and produce a "temperature layer", which bends and distorts the sound waves in the same way that a prism bends light waves.

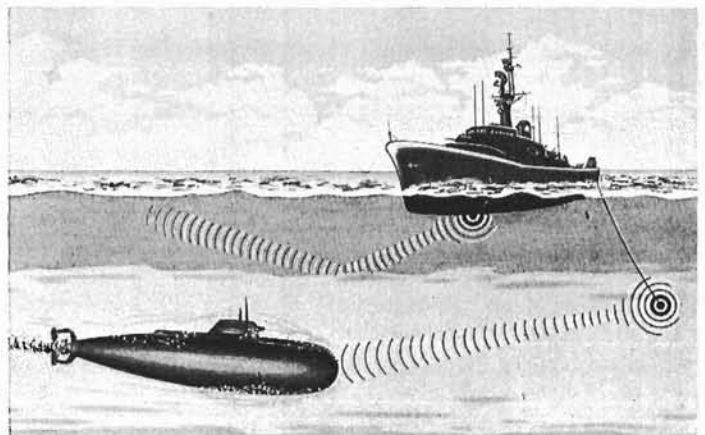

Figure 3: How variable depth sonar works. (CN-6031)

The submarine can be attacked with one of two ship-borne weapons: a pattern of depth bombs, or with a torpedo which homes onto or seeks out the submarine.

Figure 4 shows a Tribal class destroyer. There are 11 ships of this type which were built during and shortly after the Second World War. They are equipped with guns for use against surface and air targets and also shore bombardment. They also have good anti-submarine equipment and weapons. Thus they are versatile ships with a good general purpose capability. But, after distinguished service, they are rapidly wearing out and should be phased out completely by 1970.

Next we have the St. Laurent class destroyer escort. These ships entered service in 1955 and there are seven of them. This was the first Canadian-designed A/S ship.

In recent months there has been quite a lot of public speculation about the capability of our modern destroyer escorts, the St. Laurents and their successors. The sailors nicknamed these ships "Cadillacs" when they first joined the Fleet, not only because of their cost but because they were the best and latest of their kind.

What is their potential today? Are they up-to-date? This is important because these ships, the St. Laurents and their successors, the Restigouches and the Mackenzies, will form the backbone of our A/S surface forces for several years ahead.

The seven St. Laurents were designed in 1949 and completed from 1955 onwards. The seven Restigouches and six Mackenzies, which followed, were both designed in 1956 but the basic design was the St. Laurent. The Restigouches were completed between 1958 and 1960 and the Mackenzies, which are essentially repeat Restigouches, are just being completed now. Three Mackenzies have been commissioned and the class will be completed in 1964. The last two Mackenzies will be a great advance on the 18 earlier ships for reasons which I will come to.

These 20 ships are all highly specialized anti-submarine vessels. They were designed to destroy the modern conventional submarine. As you might expect they are a great advance on anything we had in the Second World War, but so is the modern, conventional submarine.

But the really significant advance in naval warfare was the advent of the nuclear submarine *Nautilus* in 1957, to be followed by the Polaris submarines in 1960. These events changed matters almost overnight. Instead of having to deal with submarines with fairly high submerged speeds, but very limited endurance underwater, navies are now faced with the problem of hunting submarines, with very high submerged speeds, greater diving depth and sustained underwater endurance. In fact, as far as the nuclear submarine herself is concerned, she can stay under water for months on end. Fortunately for us, at the present time there are comparatively few of these boats at sea, but many more will undoubtedly come.

One of the most urgent military problems confronting the West—and for that matter the East also—is the problem of defence against the nuclear submarine armed with long-range missiles—or indeed against any nuclear submarine.

Our present destroyer escorts have a very limited capability against nuclear submarines, but they are first-class against conventional submarines which, as you have heard, constitute the vast majority of submarines in the Russian fleet today.

However, what are we doing about defence against the nuclear submarine?

Much research and development has been done and continues. Although the problem is a long way from being solved, there are promising developments and some good hardware has been produced. In Canada we have developed variable depth sonar which provides more reliable detection at increased ranges. This device is being fitted in the last two Mackenzies, which



Figure 4: HMCS Cayuga, Tribal class destroyer escort. (OT-3357)



Figure 5: HMCS St. Laurent before conversion.



Figure 6: Artist's conception of converted St. Laurent class destroyer escort, with helicopter platform, hangar and variable depth sonar. (CN-6407)

I mentioned earlier. The seven St. Laurent escorts are also being converted to carry variable depth sonar.

At the same time as they are being equipped with variable depth sonar, our destroyer escorts are being given landing platforms, and the facilities for operating helicopters, which will carry both sonar and weapons. This is an important Canadian concept, the idea of operating a large, all-weather, A/S helicopter, equipped with both sonar and weapons from a destroyer escort. The Sikorsky HSS-2s are on order and the first was accepted for trials in May. These helicopters will be much faster than nuclear submarines. This destroyer escort helicopter combination will normally work as a unit.

Figure 6 is an artist's impression of a converted St. Laurent. The first ship of this class to be converted is the *Assiniboine* who will complete her conversion this month and will commence helicopter trials in October on the East Coast. These will be extensive trials lasting at least six months. She will be joined by the converted *St. Laurent* herself in early 1964. It is planned to complete the conversion of seven St. Laurents by the end of 1965.

Finally, we have (Figure 7) the slowest of the escorts, the Prestonian class frigates. There are 17 of them. They are smaller than the destroyer escorts and



Figure 7: HMCS Beacon Hill, Prestonian class frigate. (E-44533)

much less complex. They have an ASW capability against conventional submarines and a twin four-inch gun which gives them a surface-to-surface capability. Like the Tribals these ships are rapidly reaching the end of their economical lives.

The RCN also has in commission 10 Canadian-built coastal minesweepers (Figure 8).

The life expectancy of these ships when certain improvements have been made is estimated to be in the mid 70s.

Submarines

TURNING FROM surface ships to undersea craft, the RCN requires submarines for training RCN and RCAF anti-submarine forces and also for use in anti-submarine operations.

Experience in other navies has shown that submarines themselves are very effective in the detection and destruction of other submarines. The submarines required for this anti-submarine role are specially fitted for the task and carry long range detection devices. Carrying these devices deep into the ocean and away from the surface noise and weather, the anti-submarine submarine can hover silently and listen out for an enemy. It has the capability of detecting other sub-



Figure 8: HMCS Miramichi, coastal minesweeper. (E-43508)

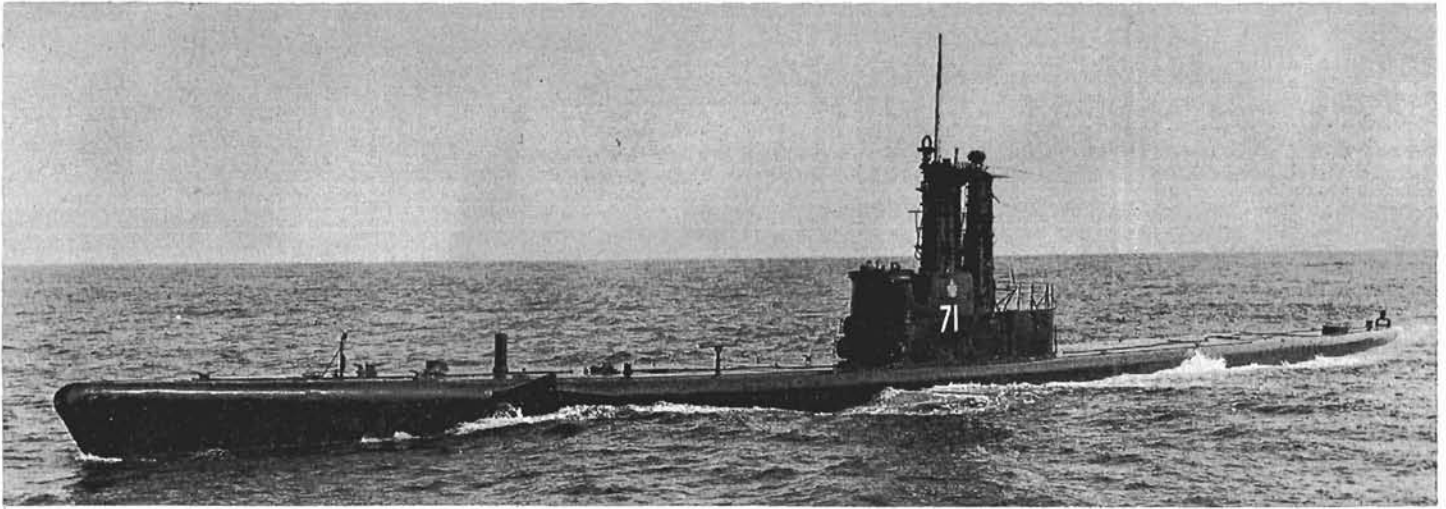

Figure 9: HMCS Grilse, West Coast submarine on loan from the USN. (E-63569)

marines many miles away and it is thus an important member of the anti-submarine team.

Anti-submarine warfare must be a team effort. This, together with the conditions of wind, weather, ice, and the vastness of the sea which surrounds Canada, dictate that ideally our anti-submarine force should be a comprehensive anti-submarine team consisting of ships, submarines, aircraft and fixed installations. The addition of submarines to our present maritime forces would improve and diversify our anti-submarine capability. It would also greatly increase the overall operational effectiveness of our forces and improve the operational training of the crews. Our surface and air A/S forces require constant practice with submarines to achieve a high state of training.

At present this training requirement is partially met on the East Coast by the loan of three submarines from the RN, two of which are normally on station while the other is undergoing refit; and on the West Coast by the loan of one submarine from the USN.

The loan agreement between the British Admiralty and the RCN requires that we pay operational and

maintenance costs and provide some of the personnel to man the three East Coast submarines. The agreement has been in effect since 1955 and has provided much of the live submarine practice on the East Coast. These RN submarines are unlikely to be available after 1966 or 1967 and the Admiralty is not planning to replace them.

In the case of the submarine *Grilse* on the West Coast, she is on loan for five years from the USN and is completely manned by RCN personnel (Figure 9).

Aircraft in the RCN

TO COMPLETE the picture of RCN A/S vehicles we should now look at carrier aircraft, and Figure 10 shows a CS2F or Tracker.

We have 72 of these modern fixed-wing A/S aircraft, up to 18 of which are carried in the *Bonaventure*. The remainder are shore-based, where some are employed for advanced operational training, and others are available as back up for the carrier. The Trackers carry submarine detection equipment and anti-submarine torpedoes.



Figure 10: A Tracker aircraft (CS2F) as borne in HMCS Bonaventure. (DNS-23997)



Figure 11: The HSS-2, latest A/S helicopter, which is being acquired by the RCN. (CN-6572-R)

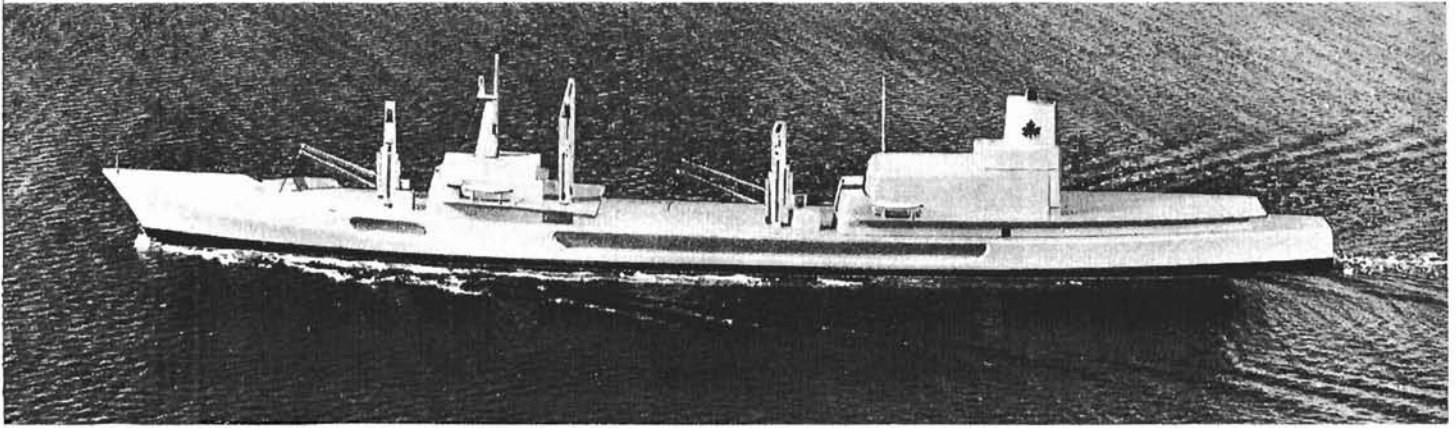

Figure 13: HMCS Provider, fleet replenishment ship, entering service this year. Artist's conception.

Figure 11 shows the HSS-2 helicopter using its dunking sonar. Dunking or dipping sonar is the name given to the helicopter's submarine detection device. It is similar in principle to the variable depth sonar which I described earlier.

The HSS-2 is the latest A/S helicopter, and was designed in the United States specifically for A/S operations. It is an all-weather helicopter and in addition to its dunking sonar for the detection of submarines it carries anti-submarine torpedoes for the attack.

Six of these helicopters will be carried in the *Bona-venture* and one will be carried on each of the converted St. Laurent class destroyer escorts. Three CHSS-2s have recently been supplied to the RCN.

Afloat Logistic Support

A DESCRIPTION of the fleet would be incomplete without a few words on afloat logistic support. NATO nations are individually responsible for the logistic support of the forces they provide to the Alliance.

Any maritime force should have afloat support facilities, for maximum operational effectiveness, flexibility and mobility. Wherever our combatant ships are to be found, and whatever they are doing, there must be satisfactory arrangements for their replenishment with fuel, ammunition and stores, and also for main-

tenance and repair facilities. Ideally this support should be afloat, and move to a distant area with the combatant ships. Afloat logistic support is also a very satisfactory means of dispersing stores and facilities from our shore bases.

We now have two Cape class maintenance repair ships (Figure 12), which although old and slow, are adequate for their purpose. A new fleet replenishment ship, HMCS *Provider*, will enter service this year.

Aside from their normal role of replenishment and repair these vessels, particularly the Cape class, possess a good capability for carrying Army troops and their equipment.

Figure 13 shows an artist's conception of our new fleet replenishment ship, the *Provider*. The *Provider* will be able to replenish at speeds up to 20 knots and will carry fuel oil, diesel fuel, avgas, ammunition, spare helicopters, and dry stores.

The *Provider* is a large ship, 22,000 tons, 551 feet in length, a beam of 76 feet and a draught of 30 feet. She will have a top speed of 20 knots and a crew of 159. She is being built in Lauzon, Quebec.

Another interesting vessel under construction in Esquimalt, is this research ship (Figure 14). She will be operated on the Pacific Coast by the Navy, as required by the Pacific Laboratory for the Defence Research Board.

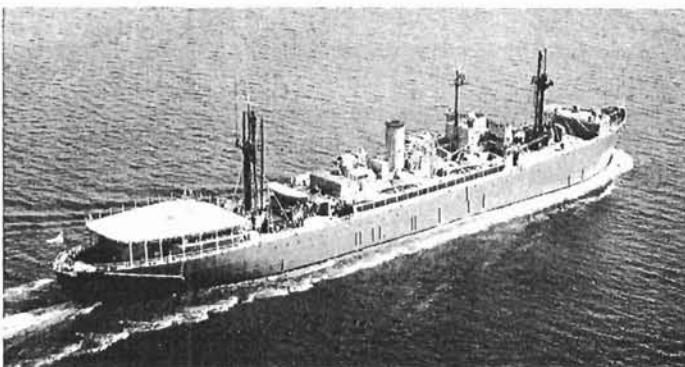

Figure 12: HMCS Cape Breton, maintenance repair ship. (E-66886)



Figure 14: Research ship under construction at Esquimalt.

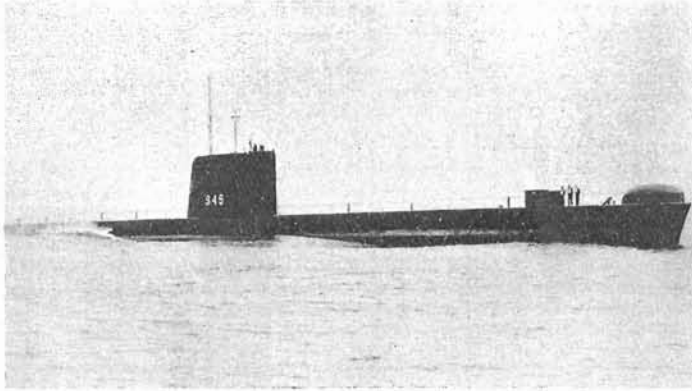

Figure 15: A British Oberon class submarine. (CN-6433-R)

She will be 235' long, 38' beam and displace 1,600 tons. She will have a diesel-electric drive, be very quiet up to six knots and have a top speed of 16 knots. She will have a long endurance, so 60 days of refrigerated storage is being provided, and she is also being stabilized. She will have accommodation for 12 scientists and a crew of 26.

Replacement of Overage Ships

GENTLEMEN, I have described very briefly the existing fleet and the ships under construction. As I mentioned, the nine Tribal class destroyers and 17 frigates are rapidly reaching the age where it is becoming uneconomical to keep them in commission for much longer. Two Tribals and one frigate have already been replaced by three Mackenzie class escorts.

Between now and 1970, the remaining 26 ships will reach their normal age limit. Our present commitment of 43 escorts is being met by 17 post-war St. Laurent type escorts and the 26 older ships.

In addition to the three overage ships that have already been replaced, a further three ships will be replaced by the last three Mackenzies which will be completed by next year. In order to maintain our commitment at its present level it will be necessary to continue the replacement program to provide modern units.

In this connection, I would like again to refer to the need in the RCN for submarines to train A/S ships and aircraft. SACLANT has indicated that ocean-going A/S submarines, acquired by the RCN to train A/S forces, could also be counted toward NATO force goals, in the ratio of one submarine to one anti-submarine escort. It is for this reason, that we regard submarines as replacement vessels. Approval in principle was given last year for the purchase of three conventional submarines of the Oberon class, subject to satisfactory negotiations with Britain.

Figure 15 shows an Oberon submarine. These are the latest conventional ocean-going A/S submarines. They would serve us well for up to 20 years for training and also for several years for A/S operations.

General Purpose Frigate

IN MARCH 1962, the government approved the construction of eight General Purpose Frigates (Figure 16) as part of the ship replacement program. These ships would be somewhat larger than the present destroyer escorts, and would give the fleet the versatility which the Tribal destroyers have provided in the past. They would have an anti-submarine capability. They would introduce for the first time into the RCN, surface-to-air guided missile systems for anti-air defence. In addition, the ships would carry a general purpose helicopter and a gun with a good surface-to-surface

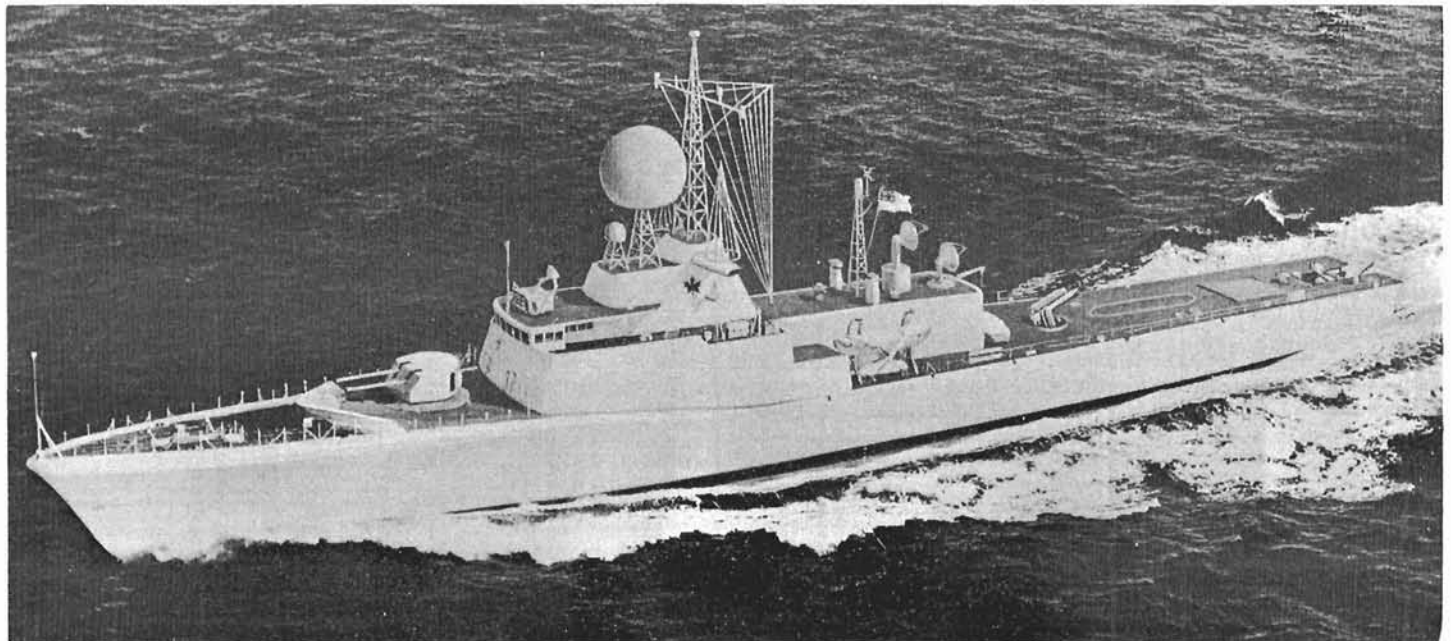

Figure 16: Artist's drawing of proposed general purpose frigate. (CN-6523)

and shore bombardment capability. They would also be able to carry 200 troops with light equipment and would be capable of landing and supporting those troops in practically any part of the world.

These ships would replace the over-age Tribal class destroyers.

You will appreciate that the men from the older ships would have to receive a good deal of re-training in order to provide them with the skills necessary to maintain and operate the much more complex and modern equipment which would be fitted in this new class of ship. Plans to achieve this are in hand. This is a long term project for, as you know, it takes longer to develop highly skilled and experienced personnel than it does to build a ship.

As the Minister indicated in his opening statement this program is under review.

Hydrofoil—R-200

ANOTHER very interesting vessel, for which a contract was recently let to deHavilland is the ASW hydrofoil R-200. Figure 17 shows an artist's conception of an ocean-going A/S hydrofoil craft. The hydrofoil first appeared at the turn of the century, but it wasn't until after the Second World War that development started in earnest. Development of this principle has been conducted in various countries including the United States, Italy and the Soviet Union as well as in Canada. No country has yet produced an ocean-going hydrofoil. We hope Canada will be the first to do so. Our effort is complementary to that of the United States. We look upon this project as a development program and we are working on the design for a weapons system for the craft, should it prove to be a useful ocean-going addition to the fleet.

The hydrofoil will be 151½ feet in length, have a beam of 21½ feet and a draught of 23 feet in the displacement mode and 7½ feet when foil borne. In the displacement mode the ship will displace 180 tons and

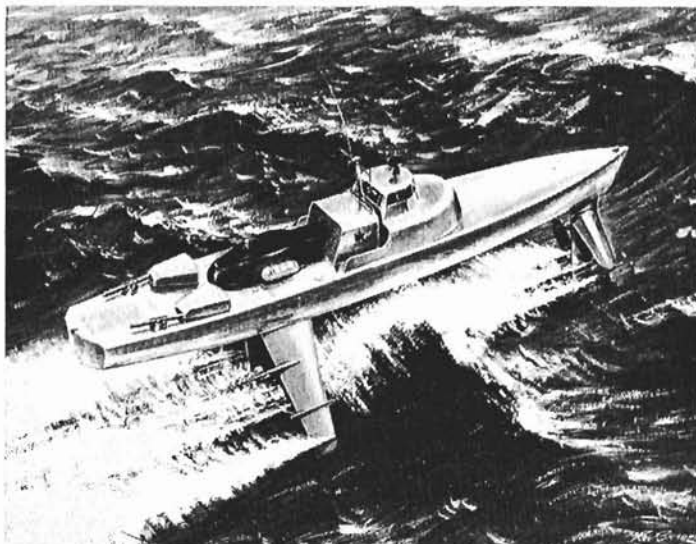

Figure 17: Ocean-going A/S hydrofoil craft under development for the RCN. Artist's conception. (CN-6571)

cruise at about 16 knots. She will do over 50 knots when foil-borne. Her crew will be something over 20 personnel.

This Canadian development program, if successful, should place our industry in the forefront of hydrofoil design and construction. It would provide industry with the knowledge, advanced techniques and skills required to meet future national defence requirements and also to compete favourably with other foreign countries.

That completes a survey of the ships and aircraft we have and expect to have in the immediate future.

Organization

I WOULD like to show you very briefly the basic organization of the RCN (Figure 18).

Approximately 2/3 of the RCN is serving on the Atlantic Coast and 1/3 in the Pacific.

The two most important parts of the Navy are the ships including aircraft and the personnel of the Navy.

ORGANIZATION OF RCN

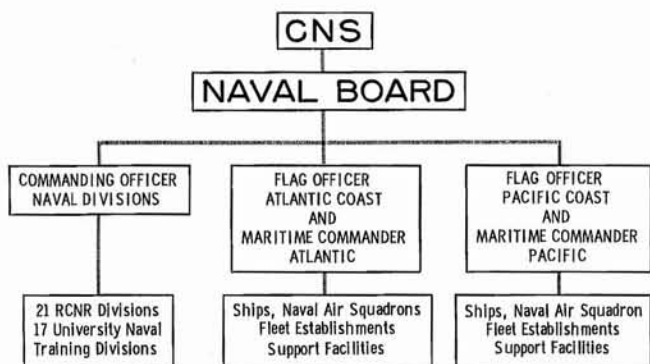

Figure 18

RCN MANPOWER

OFFICERS, MEN, CADETS AND APPRENTICES
CIVILIANS

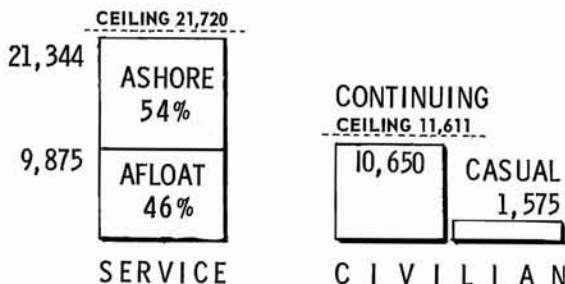

Figure 19

NAVAL EXPENDITURE by CATEGORY

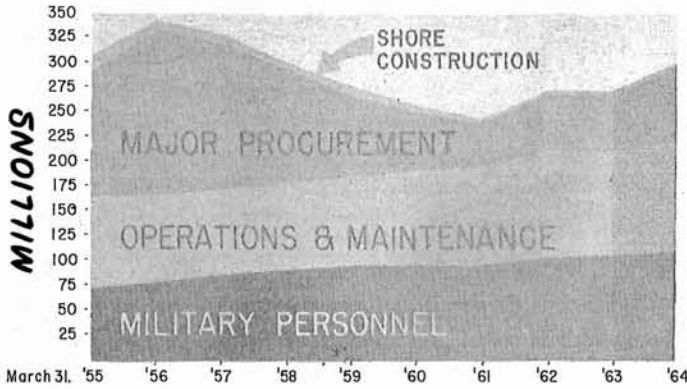

Figure 20

Today, the authorized strength of the Navy is 21,720. Against this are borne 21,344 officers and men (Figure 19). Of these some 46 per cent are serving at sea and the balance ashore. The great majority of those who are employed ashore are either instructors or are under instruction in the Fleet Schools. The remainder are employed in billets suitable to their trades, thus permitting a necessary measure of rotation between sea and shore duty.

I would like to emphasize again the importance of the training task facing a modern-day Navy. As equipments become more and more sophisticated, the need for higher degrees of maintenance and operating skills increases. These needs must be met by continuous and progressive effort by ships and schools. This challenge is being met in a most heartening manner by all concerned.

It has long been the policy of the Navy to employ civilians to the greatest possible extent in shore establishments and support activities. At the present time 11,611 civilians are so employed, and provide most useful and loyal service to the Navy in a great many fields.

Naval Expenditures

FINALLY what does the Navy cost? Figure 20 shows expenditures by category from 1955 to 1963.

Naval expenditures were reduced progressively from 1956 to 1961 and you can see how procurement of equipment was squeezed out between a lower total vote and slowly rising operational costs.

In Figure 21 we see expenditures on operations and maintenance, broken down further. You will note that maintenance costs since 1955 have remained much

NAVAL EXPENDITURES OPERATIONS & MAINTENANCE

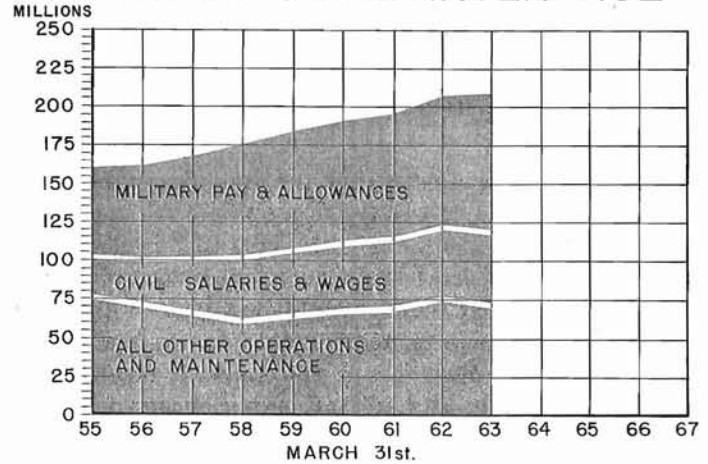

Figure 21

the same, despite increased wages and material costs. Also, the number of ships in commission has increased during this period.

The Navy is constantly looking for extra yardage from defence dollars because, as in so many other enterprises, costs are rising. The wonderful new equipment which is becoming available is much more effective, but it is also much more costly.

Conclusion

IN CONCLUSION, may I point out that the best way to gain a better understanding of maritime defence, and naval problems, is to visit ships and establishments, to see the Navy operating, to talk to Naval personnel on the job, and if possible, to go to sea.

I would like to extend a very cordial invitation to the members of the Committee to visit ships and establishments at any time. I know you will be welcomed aboard.

I believe the economic, military and political importance of the oceans is becoming more widely recognized and that during the '60s and the '70s we will see much larger merchant navies and more powerful fighting fleets in many parts of the world.

I think that in the present RCN we have an effective, modern Navy, with a sound base for future growth. We recognize the necessity to maintain and increase our effectiveness and versatility in the face of changing conditions. The challenge for us is to ensure that our country, with its three long coast lines, the longest in the world, will have a strong Navy in the years to come. We will do our utmost to meet this challenge but we need the blessing and firm support of the people of Canada.

RCN NEWS REVIEW

Bravery Award For Petty Officer

PO Frederick G. Hasler has been awarded the Queen's Commendation for Bravery for saving a man from drowning in the Chaudiere River in July 1961.

PO Hasler saved a man's life when he dived into the Chaudiere River and brought the drowning victim up from the bottom at considerable risk to his own life.

PO Hasler had been at Garneau Beach near Lauzon, with two friends who were not strong swimmers and knew he could expect no assistance in the water from them. But, without hesitation he dived into the river and grasped the drowning man, who had gone down for the second or third time. Once the man was brought ashore artificial respiration was administered and he recovered.

Born in Hamilton on June 16, 1930, PO Hasler entered the Royal Canadian Navy in October 1951 as an ordinary seaman.

He has since served at establishments on both coasts and at Montreal and Hamilton, and at sea in the aircraft carriers *Magnificent* and *Bonaventure* and the destroyer escort *Sioux*.

PO Hasler, his wife and two children make their home at 28 Erin Drive, Dartmouth, N.S.

Ships Welcomed On Europe Visits

The visits of six destroyer escorts of the Fifth Canadian Escort Squadron to Kiel, Germany, and Copenhagen, Denmark, during July were unqualified successes, according to the Canadian Ambassadors to West Germany and Denmark.

In a message to the Commander Fifth Canadian Escort Squadron, Captain C. P. Nixon, His Excellency the Canadian Ambassador to West Germany, John K. Starnes, said:

"I would like to express to you and all the officers and men under your command my appreciation of the magnificent way in which the Fifth Escort Squadron represented Canada in Kiel. There is no doubt that the visit was a great success. I would also like to express my personal thanks for the warmth of your hospitality."

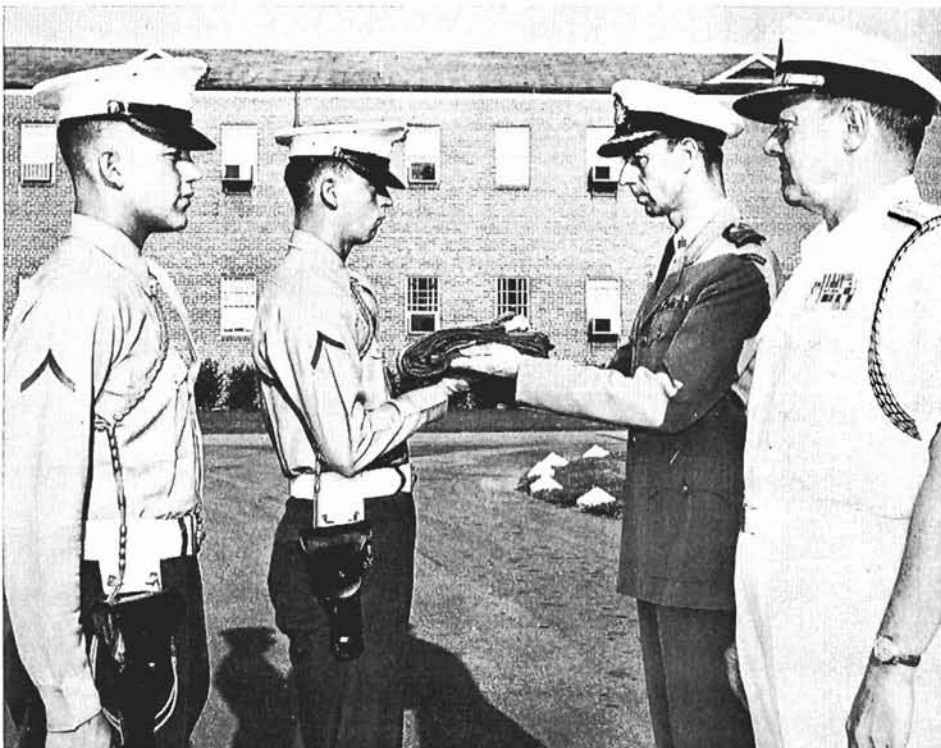

Ceremonies commemorating the 96th anniversary of the founding of the Dominion of Canada were conducted on July 1 at the headquarters of Admiral H. P. Smith, USN, Supreme Allied Commander Atlantic, in Norfolk, Virginia. Captain R. W. Timbrell, Canada's representative at the honour ceremony, hands the Canadian flag to a Marine colour guard for the national day honours. Vice-Admiral John McN. Taylor, USN, Chief of Staff (right), presented the Canadian colour for the ceremony. (SACLANT Photo)

From His Excellency, the Canadian Ambassador to Denmark, Hector Allard, the following message was received:

"The visit of the Fifth Canadian Escort Squadron to Copenhagen has resulted in much favourable comment and praise, including that from various officials and diplomatic colleagues, and interesting publicity. I join with many others in thanking you, your officers and your men for a memorable occasion.

"We would of course have liked to have had you here on July 1, our Na-

tional Day. However, as this was not possible, your arrival on the second day of the month resulted in extending our annual celebration over a three-day period.

"The appearance, conduct and bearing of your ships' companies was in the highest traditions of Canada's Navy and I look back to your seven-day visit with great pride and satisfaction. It was a pleasure to meet you personally and I sincerely wish you and your squadron bon voyage."

The *Chaudiere* and her five sister-ships, the *St. Croix*, *Terra Nova*, *Gatineau*, *Kootenay* and *Columbia* were on an eight-week training cruise that took them to Plymouth, England, Kiel, Copenhagen and Londonderry. The Canadian warships arrived at 'Derry on July 12 for an operational visit lasting until July 28, during which they took part in the exercises with the British Joint Anti-Submarine School.

Sign Gets Laugh —and Attention

It may or may not be original, but a little sign near HMC Dockyard, Esquimalt, got a few chuckles.

New grass was starting to sprout along a boulevard just finished near the naval base. Stuck in one corner was a notice which read: "Caution: New Blades!"

Assiniboine Rejoins Fleet

HMCS *Assiniboine*, first St. Laurent class destroyer-escort of the Pacific Command to undergo major conversion for a new anti-submarine role, was re-commissioned at HMC Dockyard on June 28.

The conversion featured installation of variable depth sonar and the addition of a helicopter flight deck and hangar. The ship now also has two funnels located athwart ship. Initial work was done by the shipbuilding firm of Victoria Machinery Depot Co., Ltd., with completion being handled in the Dockyard. The conversion was started in June 1962.

Commanding officer of the *Assiniboine* is Cdr. Walter Blandy, native of Victoria, who has described the converted ship as the most deadly anti-submarine warship anywhere.

The ship carries 235 officers and men, most of whom are from homes in Western Canada.

The *Assiniboine* will proceed in early autumn to Halifax to join the Atlantic Command.

PO Appointed to Moscow Post

PO Robert Brockley, of Windsor, Ont., and Halifax, has recently joined the staff of the Canadian Naval Attaché to the Ambassador of Canada to the USSR in Moscow. Accompanied by his wife, he will reside in Moscow for the next three years while carrying out his duties.

PO Brockley entered the Royal Canadian Navy as an ordinary seaman in November 1962. Following his basic training at *Cornwallis*, he specialized as an administrative writer and has served at establishments in Halifax, Esquimalt, London, Ont., and Montreal, and at sea in the cruiser *Quebec* and the *Bona-venture*.

He has been serving for the past year at HMCS *Niobe*, in London, England.

Officer Heads Technologists

Lt. Robert G. Armstrong is the new national vice-president of the Canadian Society of Laboratory Technologists (SLT). He is officer in charge of the clinical laboratory at the Canadian Forces Hospital in Halifax.

Lt. Armstrong served during the Second World War in the RCNVR, thereafter attending Ontario Veterinary College, Guelph, Ont. He married the former Jean Miller of Ottawa in 1946.

Let Each Look After His Own

The smallest Navy League Cadet embarked in HMCS *Crescent* during her Halifax to Lauzon refit run in July was a bespectacled nipper, Paul MacGillivray, 12-year-old Haligonian.

Cdr. V. J. Murphy, the captain, was quizzing him on the bridge to test his nautical know-how. Asked what he'd do if the ship had a disaster and began to sink, Cadet MacGillivray replied:

"I'd put on my life jacket and jump overboard, sir."

Cdr. Murphy pointed to hungrily cavorting whales and porpoises through which the *Crescent* was steaming at the time and asked:

"But what about them?"

Answer: "They'll have to get their own life jackets, sir."

It took quite a while to restore the command position to normal.

He rejoined the Navy in 1949 as a petty officer, serving in the Korean war theatre, and was commissioned in 1956. He has been in charge of naval laboratories on both coasts.

In 1958 he was elected president of the Vancouver Island Academy of CSLT and in 1960 Nova Scotian branch director of the national executive. Later he was elected national chairman of public relations and membership. He was public relations chairman for the second North American conference of medical laboratory technicians in Washington in 1962.

This year he chaired the 27th national convention of the CSLT June 23-27 in Halifax at which time he was raised to national vice-president.

Wartime DOP Dies in Halifax

A member of the fifth term at the Royal Naval College of Canada which



CAPTAIN E. A. THOMPSON

he entered in August 1914, Captain E. A. Thompson, RCN (Ret), died suddenly in Halifax on July 4.

Captain Thompson had retired before the Second World War but returned to the Navy to serve for most of the war as Director of Officer Personnel. He was awarded the OBE on New Year's Day, 1946, the citation observing:

"For the greater part of the war he has been almost entirely responsible for appointments of all officers, ashore and afloat. The remarkable lack of misfits, particularly at sea, is a tribute to his psychological acumen and justice."

A private funeral for Captain Thompson was held on Friday, July 5, from All Saints Cathedral, Halifax.

First RC Chaplain Of Fleet Dead

The Rt. Rev. Basil Martin, RCN (Ret), the first Roman Catholic Chaplain of the Fleet in the Royal Canadian Navy, died on July 25, at Truro, N.S., at the age of 62 years.

Funeral services, with naval honours, were held from Immaculate Conception Church, Truro, on July 29.

A native Haligonian, Monsignor Martin came from sea-faring ancestors on both sides of the family. At the outbreak of the Second World War he sought entry to the Royal Canadian Navy but the chaplaincy service had not been organized at that time and Monsignor Martin worked among naval personnel with the Canadian Army rank of major.

When the RCN formed its chaplaincy service in February 1941, Monsignor Martin became senior chaplain Halifax and a member of the naval service.

In November 1942 he was transferred to Ottawa as staff chaplain and served as assistant principal chaplain until becoming Chaplain of the Fleet (RC). He organized the Roman Catholic chaplaincy service for the RCN in Britain and he served for three months at sea in the armed merchant cruiser HMCS *Prince David*. He was awarded the OBE in the 1945 New Year's Honours List and retired the following September after having served for nearly six years.

Monsignor Martin brought to the RCN considerable experience as a naval padre. From 1927 to 1937 he was a parish priest in Bermuda and during that time served as a part-time chaplain with the Royal Navy.

On his retirement from the RCN, Monsignor Martin returned to his former parish at Ketch Harbour, in the archdiocese of Halifax. He was succeeded as Chaplain of the Fleet (RC) by Rev. M. P. MacIsaac.

THE LAST DAYS OF SAIL

Part Four

IT was two years before there was any great amelioration in general living conditions in the Royal Navy. By that time "Jackie Fisher" had become First Sea Lord and had embarked on a scheme of long overdue reform so far as the lower deck was concerned. The following circular was issued to the fleet:

"The attention of receiving officers is to be drawn to the fact, that as regards fresh meat and other provisions received from contractors, the prices at which articles are supplied, are not to influence their judgment. Quality alone, as provided in the contract specifications, is to be the consideration which should decide the acceptance or rejection of all articles supplied to the fleet."

The result was an immediate improvement in our food. There was more flesh than bone on the meat and it was obvious that for years someone had been getting a handsome rake-off at the expense of our stomachs.

Admiral Fisher thought of everything. He stopped the practice of making tea for the whole ship's company in the coppers by issuing the following instruction:

"As regards the tea ration, it appears to be the general practice on board ship to place the whole quantity issued for the various messes into the coppers at one time, the result being a decoction instead of an infusion. My Lords have therefore decided that this practice is to be discontinued and that when practicable, the tea is to be issued to the messes in a raw state and facilities are to be afforded by supplying hot water to enable messes to prepare the beverage themselves."

This decision enabled us to distinguish between a "decoction" and an "infusion" and also had the undoubted advantage, only to be appreciated by the lower deck, that the tea no longer tasted of onions and salt pork, from which odour the coppers, however well scrubbed, could never be entirely free. The new practice of "wetting the tea" in "fannies" was welcomed by all.

Furthermore the men had no longer to pay a mess bill at the end of the month. In some cases, if they did not take up all their rations, they became entitled to a considerable mess allowance, receiving extra money in lieu, with which they were able to buy extras

from the canteen such as eggs and bacon and tins of sardines. Hitherto sugar, milk, tea, butter and potatoes had been the first things to go down on the canteen chit, adding quite a lot to the mess bill, but these things now became part of the ration.

Another reform was in regard to the length of service. A man was no longer forced to remain with the colours for 12 years from the age of 18. Now he could enlist for five years, with seven in the reserve, so that he could leave at the age of 23 and not be obliged to remain with the navy until he was 30 when he would find it hard to get a job in civil life. There was no full employment in those days, you must remember.

By
Arthur Walpole

The new scheme had an immediate effect. There was now no longer any shortage of recruits. The new short service ratings became known as "Ticklers" after a certain brand of jam which was issued at the same time.

Even so, life was tough in the navy in those days. I remember one morning when we were being inspected at divisions, an able seaman, one of the roughest of our rough company, was called out for being dirty. He stepped from the ranks and began to abuse the officer. Leading Seaman Livingstone who was in charge, thereupon knocked him cold and, muttering an apology to the commander, said audibly, "You'll have no more trouble with him, sir". Just that.

IN THE *EGERIA* we were uncomfortably overcrowded. I leave it to you to imagine what it was like in those cramped quarters with all the hammocks slung the regulation 18 inches apart. The lucky boys slung their hammocks in the foc'sle where they could get fresh air coming up through the hawsepipes. The less fortunate had to sleep half stifled in the other part of the deck. We had no sick bay on board. The sick or injured had to manage as best they could until the ship came to a port and they could be transferred to the naval hospital at Victoria.

During my service in the *Egeria* we had two fatalities. One of the boys was killed in an accident at Esquimalt. The other was Leading Seaman Livingstone, to whom I have already referred. Although he was a strict disciplinarian, he was generally popular. He unhappily died of pneumonia. He was caterer of my mess and I was chosen to be one of the funeral party, my first experience of the kind. I was one of the coffin bearers and we had to draw the corpse on a gun carriage for three miles to the cemetery.

Dead men's effects were sold immediately after the burial of their owners. They were laid out on the upper deck and put up for auction. Quite often large sums were realized, for once an item had been knocked down, it was handed back for sale again. I have known as much as £100 to be raised in this way apart from a whip round for the man's widow. In Livingstone's case the crew subscribed for a headstone and his grave was maintained by the ship's company while the *Egeria* remained in commission.

The now familiar battleship grey was not introduced 60 years ago. The *Egeria* had a black hull and was copper sheathed below the waterline, with white upper works and yellow masts. When we were under sail the two-bladed propeller was disconnected from the main shaft and hoisted up through the screw well, clear of the water, thereby increasing our sailing speed. We could sail at between six and eight knots, whereas our steaming speed, as I have said, was 11 knots. Sailing was frequently interrupted, as quite a lot of the men would be away in boats when we were surveying.

WE HAD two steam pinnaces, the *Herald* and the *Alert*, two 14-oared cutters, a jolly boat, a whaler, a captain's gig and a wardroom skiff, which hung at the stern rails for use by the officers. It was manned by two boys in turn to avoid favouritism, for the crew of the wardroom skiff had a cushy job. The pinnaces were Heath Robinson affairs about 25 feet long, with covered-in stokeholds amidships. The stoker fed the fire from sacks of coal on the deck and the stoker petty officer worked the engine under the enclosed hatch, putting out his head from time to time to get a breath of fresh air. Each pinnace was steered

by a tiller and there was a tiny cabin in the stern which could take six men at a pinch. There was a regular crew of five—a coxswain, two ratings, a stoker petty officer and a stoker. And both the *Herald* and *Alert* had jaunty brass funnels which had to be kept beautifully polished.

They were used in making the surveying lines for soundings, keeping a straight course between two marks which had to be large enough so that they could be seen right across the strait. To do so, big tripods were erected on a convenient rock. Often it meant scaling a cliff shortly after dawn with the officer carrying a theodolite and the rest of the party armed with pick-axes and spades to clear the selected space. Trees were felled to form the tripod and it was made conspicuous by wrappings of red and white canvas. A boy carried a pail of whitewash and paint for the purpose. When on such expeditions we took with us a day's rations for often we had to climb 2,000 feet but usually there were paths to make the ascent easier. And at night we were taken off by one of the pinnaces.

Often the erection of a tripod took the best part of a day. Sometimes we would find that when operations were due to begin the next morning, no tripod could be seen. It had been dismantled during the darkness by Cluchi Indians, who had purloined the canvas to make

wigwams. Incidentally, the boarding pikes came in very useful on occasion in the erection of the tripods when a smaller mark could be used. They saved the labour of cutting down trees, being firmly driven into the ground as a framework for the canvas but, of course, they could only be used in places where there was no danger from marauding Indians. Such a use for pikes was the only reason I could ever see for their inclusion in ship's stores.

The *Egeria* was equipped with a Thomson sounding machine which enabled her to take soundings without reducing speed. The pinnaces also had sounding devices of 100 fathoms of steel wire on a drum at the end of which was a 21-pound lead grab which would open on hitting the bottom. The sand brought up indicated the nature of the floor of the ocean. If it came up scratched we knew there was rock down below. It was hard work manipulating the lead grab when you had to drag it from the full 100 fathoms. A dial recorded the depth and a bell sounded when the grab touched bottom. We used an ordinary hand lead in shallow water and the sounding machine only came into operation when the water was too deep for the hand lead. The weight of a boat's lead was only seven pounds as against the 14-pound lead used in a ship.

AN INTERESTING feature of our routine work was tide watching. It was a job we all liked. A party of men was landed at a chosen point in charge of a petty officer. The tide pole was erected in a suitable position, the water being calm enough to avoid ripples which would confuse the tide watcher and yet far enough out to ensure a true record would be made of the rise and fall of the water. The tide pole, marked in feet and inches, was painted black and white. We lived in tents and took turns to serve two hour watches, making entries in our note books every half hour. At night we obtained light from a ship's lantern. We had a boat so that we could go fishing when off duty. Or we could go off to pick salmon berries, a larger edition of the common loganberry. In fact at such moments we could do as we pleased. We would remain on shore for a fortnight before being relieved—quite a pleasant break for all concerned.

In the course of our duties we landed from time to time at various towns and villages on the foreshore of the island. One was Alert Bay, named after one of our pinnaces, an Indian settlement with an elaborate but crudely decorated totem pole, some 12 feet in height, set in the middle of an open space. There were various deities at intervals, each one separated by a firm

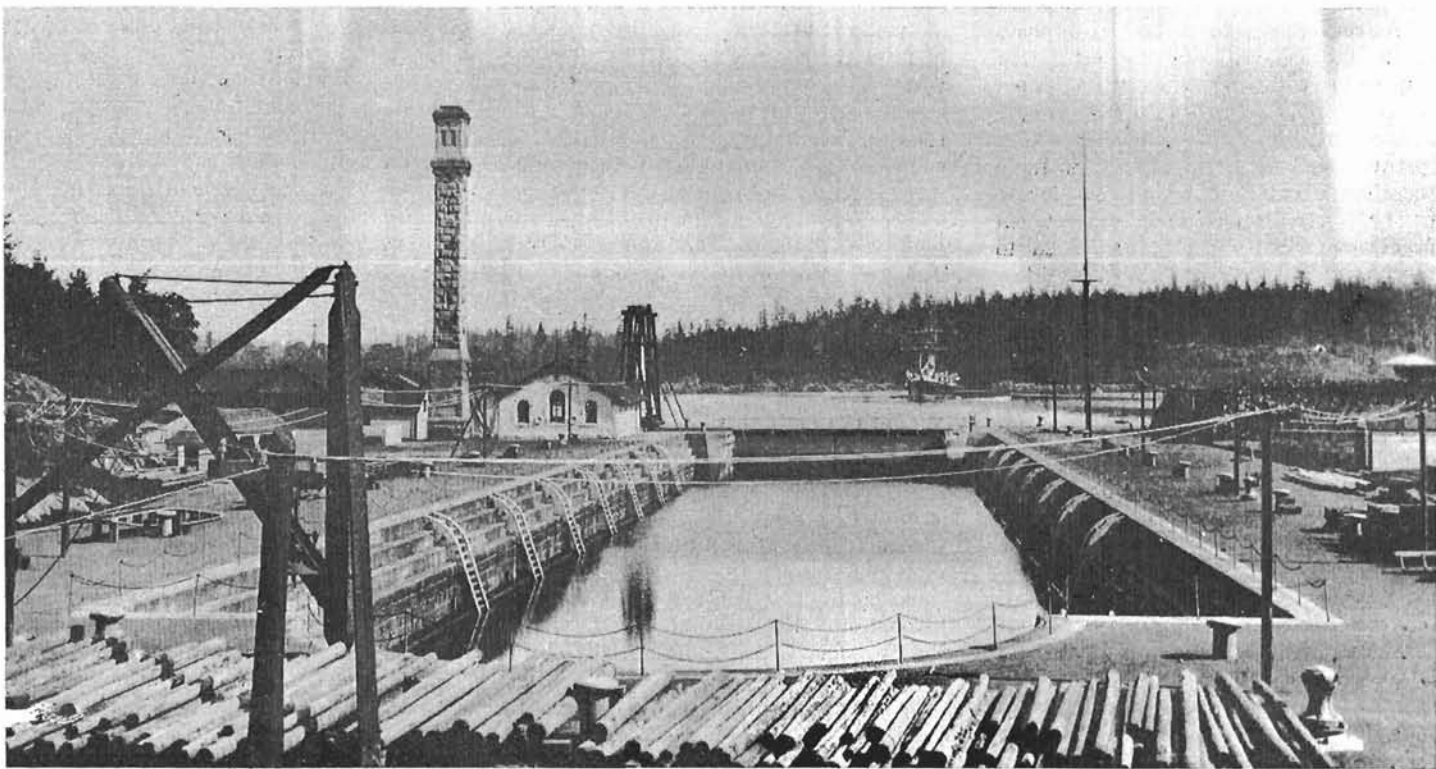

The Royal Navy's drydock at Esquimalt as it appeared a couple of generations ago. The drydock is still in service in HMC Dockyard and what appears in the picture as forested background is now the site of HMCS Naden. (E-37412)

dividing line. The natives on Vancouver Island belonged to the Haida tribe and those on the mainland to the Cluchis. They were not very numerous but were very mischievous. The island was gradually being industrialized. The second largest town, Nanaimo, was already the centre of a coal mining district. It was of far more interest to us that you could buy a tin of salmon for ten cents to vary the monotony of salt pork and hard tack.

THE MAINLAND was more interesting on account of its huge forests where lumbermen were always at work. We could watch them as we lay at anchor in one of the various creeks. You could see the immense slides running from the top of the cliff to the water's edge. The big logs were eased into position by lumbermen carrying poles with long spikes. They were giants among men. They had to be, for their work necessitated giant strength. Occasionally a log would change direction bringing about a jam, succeeding logs piling one on the other until they reached the dimensions of a small mountain. The slide could only be brought into use again by blowing up the encumbrance with dynamite. If nothing untoward happened, the big tree trunks would shoot far out into the creek where they were roped together in the form of rafts to be towed to distant sawmills by means of tug boats.

The lumberjacks used to come on board and invite us to their camps to have a closer view of how the work was done. As I have said, they were immense fellows but very cheery. With the warning cry of "Timber", they could fell the biggest tree in an incredibly short time. You would literally look up at a tall fir tree one minute and the next it was lying at your feet. Then began the task of lopping the branches and when the trunk was bare it would be hauled by wires by donkey engines to the top of the slide on its way down to the creek below.

The lumbermen were very hospitable and their huge meals cooked by Chinese servants were something I still remember. All we could offer in return was a singsong on board the *Egeria*. We sometimes entertained them at Vancouver City, when they came in for the July celebrations, with a firework display.

This was an annual event for which the *Egeria* joined up with the remainder of the fleet and there was a leave of 96 hours for each watch. The lumberjacks poured into the city with lots of money in their pockets, and how

they spent it! The saloons were packed all day and far into the night, for licensing hours were unheard of. If anyone tore a cloth in the many billiard halls, the damage was immediately paid for with piles of gold dollars. And in the merry condition of the lumbermen, there were many rents. After all, it was the only holiday they had in the course of the year. And naturally the gay women of the town shared in their lavishness. They were hardly ever quarrelsome. When all their money was gone, they cheerfully returned to their lumber camps in the mountains to save up for next year's spree.

AS A DIVERSION, the annual fleet regatta was held at the same time. The crew of the *Egeria* could not enter into the major events such as sailing and boatpulling but we came into our own in the profession of copper punts. Each ship carried copper punts for cleaning the copper sheathing above the water line. They were decorated in the form of swans or mermaids. The mermaids had a girl's head and a half submerged tail, with a rudder below to steer the punt. Others would be rigged as replicas of one or other ships in the fleet. It was here that we scored. Our punt was an exact model of the *Egeria*, every rope in place, every rope set, the little boats on their davits, gangway ladders hoisted and figures representing the crew on the deck.

TODAY when the best tinned salmon costs the earth, my mind goes back to the days when we saw the Fraser River in the spawning season. The estuary was discoloured for miles by the rushing torrent. It was alive with salmon, the fish being so numerous that it was hard to pull a boat through the water. And this is no tall angling story. Some of the fish even leaped into the boats and aboard the *Egeria* it was momentarily a case of salmon galore, cooked in every possible way, until you became heartily sick of it.

The natives had their own way of catching smaller fish, using a flat board studded with nails. They used to go out in pairs using an ordinary row boat. One man would row and the other, standing in the bows, would sweep the water with the board. If they happened

on a shoal they could bring up two or three fish at a time.

To get really a lot of fish at one swoop, a seine was used, a big net kept afloat by cork and weighted at the bottom. There was a bag in the middle in which the fish were caught. Such operations usually took place off a sandy beach and the seining party worked from the shore, the seine being taken out into the channel in the form of a semi-circle by a cutter. We used to go out seining in parties in the evening, and cook the fish at open fires on the beach and afterwards have the usual singsong.

The *Egeria* went to sea by both sail and steam. Certainly at the end of the surveying season we invariably entered harbour at Esquimalt under sail. On one occasion the sails were so frozen they could not be furled. There was only one thing to do—brail them up and wait until the weather cleared. An officer on the foc'sle had other ideas and called loudly to the men taking in the foresail to put more "beef" into it. Knowing that any amount of "beef" would not make any difference, one of the old hands, enraged, shouted back: "Shut up, you bald-headed old b . . ." He was duly entered in the captain's report, courtmartialled and given 60 days for insubordination. In the navy it is always best to keep your trap shut no matter how you feel. The inevitable "10A" followed all petty offences. It meant stoppage of the rum ration and all leave, with extra work in the dog watches.

Our surveying work generally ceased a month before Christmas and was not resumed until the beginning of March. During that period the *Egeria* was housed-in as a protection against the weather and thoroughly overhauled while the crew lived in hutments in the dockyard. She was fumigated and dried out. If necessary she went into dry-dock to be cleared of barnacles. It was here that the copper punts were used.

It also gave an opportunity to study the results of the season's work and to get new kit. Our duties took a heavy toll on our clothing and we were given a free issue of six yards of flannel, six yards of serge and six yards of duck to make new gear. If you had enough money, you would pay an experienced shipmate to do the work for you.

A fifth and final selection from Mr. Arthur
Walpole's autobiography will appear
in an early issue

HERE AND THERE IN THE RCN



Captain G. C. Edwards, commanding Officer, HMCS Shearwater, inspects the Sea Cadet Division at ceremonial divisions during which he talks to Sea Cadet Petty Officer Second Class Frederick Tessier of RCSCC Atlantic, Grand Bank, Nfld. Thirty-five Sea Cadets began a seven-week course in the Fleet School (Air) at Shearwater on July 3. (DNS-31318)



Summertime is training time for three RCNR medical wrens, all from Winnipeg, shown getting instruction in mouth-to-mouth artificial respiration procedures at the RCN hospital in HMCS Naden. From left: Gerri Sobovitch, Sub-Lt. Ann Kelley (instructor) from St. John's Newfoundland; Marilyn McVey and Doreen Bernicot. (E-72724)



Rear-Admiral J. V. Brock, left, has officially assumed the appointment of Flag Officer Atlantic Coast at Halifax. Commodore E. N. Clarke, Commodore Superintendent Atlantic, is in the Centre, and the previous Flag Officer, Rear-Admiral K. L. Dyer, now Vice-Chief of the Naval Staff is on the right. They are on the stairway to Command headquarters. (HS-72479)



These four young ladies from the Shearwater Swim Club turned in creditable performances at the Canadian swimming and diving championships at Montreal. Left to right are: Ann Marie McCarthy, Beverly Britton, who broke two Canadian records, Lynn Palmer and Arlene Henderson. The Shearwater girls were competing for the first time against the best talent from all parts of Canada. (DNS-31433)

Home from the Sea



CNA General Meeting Held

Naval veterans from as far as Sault Ste. Marie and Ottawa and delegates of other clubs affiliated with the Canadian Naval Association, converged on Toronto the week-end of June 16 for the annual general meeting, and election of officers of the CNA.

The locale was the well-appointed Chief and POs' mess of HMCS *York*, and the host club was the Pre-War RCNVR Association.

A special and welcome guest at the business session was Commodore R. I. Hendy RCN(R) (Ret). The chairman was the national president, H. A. Maynard, of Oshawa.

Correspondence brought to the attention of the meeting that another club will shortly be added to the growing list of affiliates. Cornwall Naval Veterans have organized and requested information on conditions necessary to qualify for membership in the CNA.

A letter from the secretary of the RCN Benevolent Fund Committee suggested that the CNA wait awhile before placing a CNA representative on that committee.

Sarnia was complimented on its capable handling of the recent reunion.

Many anticipated that the city holding the 1964 reunion would be announced at this meeting but, while verbal requests were made, the executive adhered to the rule that all bids must be in writing, so this news must await the next meeting.

The addition of the word "Royal" to the name of the CNA was again pressed, but Commodore Hendy advised that a slight change in the wording of a bylaw in the constitution would be advisable before seeking the permission to use the word. The change was approved and it is possible that the CNA will, in the not too distant future, be known as the Royal Canadian Naval Association.

The CNA beret flashes have come under some severe criticism from time

to time, and the president is investigating the possibility of having one designed from the national crest.

The CNA's new flag was strongly approved, and was a pleasant surprise for those who saw it for the first time.

Contacts have now been established with several western naval veterans' clubs, and the association looks forward, with reasonable optimism, to future affiliation.

The CNA sports chairman, Joseph Vechiola, reported that while the first annual CNA Sports Day on May 11 was not exactly an unqualified success, the experience gained should make the next one more successful.

Following "stand-easy", elections for a two-year term were conducted by Lt.-Cdr. R. A. V. Jenkins. It would seem that delegates were satisfied with the efforts of the previous executive since the slate of officers remained the same: H. A. Maynard, president; C. E. Moore, executive vice-president, S. R. Piner, first vice-president and publicity director; N. J. Yorston, executive secretary-treasurer, and Joseph Vechiola, sports director. The next meeting of the executive will be in Kitchener in October.—S.R.P.

40th Anniversary Of RCNVR Noted

When old salts of the RCNVR got together at HMCS *York* on April 20 to celebrate the Wavy Navy's 40th Anniversary, two of Toronto's originals from 1923 were there.

York's first commanding officer, Lt.-Cdr. Gordon B. Jackson, one of the first Canadians commissioned into the RNVR during the First World War, had support at the dinner from Alf Hearst, one of the first instructors when Lt.-Cdr. Jackson took command of the Toronto half company of the RCNVR in 1923.

Captain T. E. C. Orde presided at the dinner and indulged in some colourful yarning with the guest speaker, Rear-Admiral Patrick Budge.

HMCS *York's* present commanding officer, Cdr. Peter Wilch, not himself an RCNVR type, but an RNVR during the Second World War, represented Toronto's naval division.

Four ex-commanding officers of *York*, Captain Geoffrey Sheddon, Captain L. D. Stupart, Commodore R. I. Hendy and Commodore J. W. F. Goodchild, also attended. There were 150 at the dinner. Also at the head table was the president of Toronto's Pre-War RCNVR Association, C. E. (Pony) Moore.

As the toast to fallen shipmates was made, every light in the ship was turned out, then a single brilliant spotlight illuminated the White Ensign as it went slowly to the dip.

With a staging like that, a bugle playing the Last Post, old shipmates all around, and awakened memories, there were bound to be moist eyes.—P.W.

Morgan Heads Toronto NOA

Election of J. H. Morgan to the presidency of Naval Officers' Association of Canada, Toronto branch, was announced in July. He succeeds J. E. D. Stuart.

Mr. Morgan, a retired RCNR officer, joined the RCNVR at *Chippawa*, the Winnipeg naval division, in 1943 and continued on active service until the end of the war. Until his recent retirement from HMCS *York* in Toronto, he had been an active reserve officer in both the Winnipeg and Toronto naval divisions. Mr. Morgan heads up his own firm, Leased Sales and Merchandising Personnel, in Toronto.

Members of the executive and directors for the coming year are R. I. Priddle, vice-president; J. E. D. Stuart, immediate past president; John G. Kingsmill, treasurer; A. G. Richmond, secretary; W. E. Paterson, assistant secretary; P. L. Robinson, membership secretary, and directors H. Gardiner Cowan, W. R. Duggan, C. G. Emery, J. R. Faulds, J. L. Morris, J. K. Murray, Dr. M. J. O'Brien, C. Rathgab and A. C. Theobalds.

THE RCN'S PLOT

A NOTABLE contribution in the anti-submarine field has been made by a Canadian engineering firm, working in co-operation with the Royal Canadian Navy. This has involved the development and production by Marsland Engineering Limited, of Waterloo, Ontario of a superior anti-submarine plotting system for use in warships.

Two of the systems were borrowed by the United States Navy from the RCN in 1959 and proved so superior to the equipment in use that a \$4 million contract was placed by the USN with Marsland for similar systems. Other NATO navies are showing interest.

Before 1953, RCN practice was to procure and fit Admiralty type plotting systems. However, none was available in a reasonable length of time for fitting in the St. Laurent destroyer escorts and it was necessary to write an RCN specification. This was for the most part a performance specification, which left the methods of achieving the desired results to the designer.

The specification was circulated to industry without arousing much interest but among the replies was one from Marsland Engineering Limited, indicating that the company appeared to have both the know-how and the facilities to produce the required systems.

In 1955—the year in which the first of the St. Laurent class ships was commissioned—a contract was awarded to Marsland Engineering to produce a pre-production model of the Canadian system. The evaluations were satisfactory and the order was raised to a total of 73 systems. Four more were ordered in 1958, the total of 77 systems being used for fitting in the new construction destroyer escorts, the Tribal class destroyers, the *Sioux*, *Crusader* and *Fort Erie*, and training divisions.

In the meantime, at their own expense, the manufacturers had been seeking to improve the plotting system and by 1958-59, more than five years after the original order was placed, had achieved a major breakthrough, resulting in marked improvements in overall accuracy, reliability, slewing speeds, and the time required to calibrate the system. As a result, a contract was raised in 1961 for the modification of much of the RCN holdings, including all shipborne equipment and a portion of the training equipment, to include improvements.

The Marsland system takes information from the ship's speed log, gyro compass, radar and sonar and provides in return an accurate and continuous display of the location of two targets (they could be a submarine and an attacking helicopter) and an up-to-the-second dead reckoning of the ship's position. This is done by means of projected spots of light on a translucent screen that forms the top of the plotting table and by electro-mechanical latitude and longitude counters.

In normal use, both the plotting table and the dead reckoning indicator derive their position information from electrical signals originating in the speed log and gyro. For training purposes, manual control of speed and course is provided.

In conventional plotting methods, the course of the ship is plotted manually on charts. This is done by drawing vectors at regular time intervals, the length and direction of the vectors corresponding to the distance travelled and heading of the ship. The accuracy of a manual plot depends on how closely a straight vector represents the average course of a ship over a chosen time interval. Such variable factors as

winds, bad steering, compass errors and poor seamanship tend to reduce the accuracy of this method of plotting.

As the course vectors are drawn at specific time intervals (say every hour) they represent approximations. Accordingly, there may be discrepancies between the plotted course and the true course.

In the case of the automatic plotting table, the plot proceeds continuously instead of at fixed time intervals and actual values of speed and course are being processed instead of approximations. Thus, automatic plotting can be highly accurate where wind and current are not exerting undue effects.

On the plotting table itself, the ship's position is the centre point of a polar diagram (a compass rose with range circles added) projected onto the translucent table top. A record of the ship's course can be made simply by tracing the position of the origin on the translucent screen by means of a pencil. Targets are shown on the screen by coloured spots of light, one red and one green, representing respectively sonar data and radar data.

This is another instance of Canada being in the forefront in the development of anti-submarine equipment and one in which the manufacturer has taken helpful initiative.

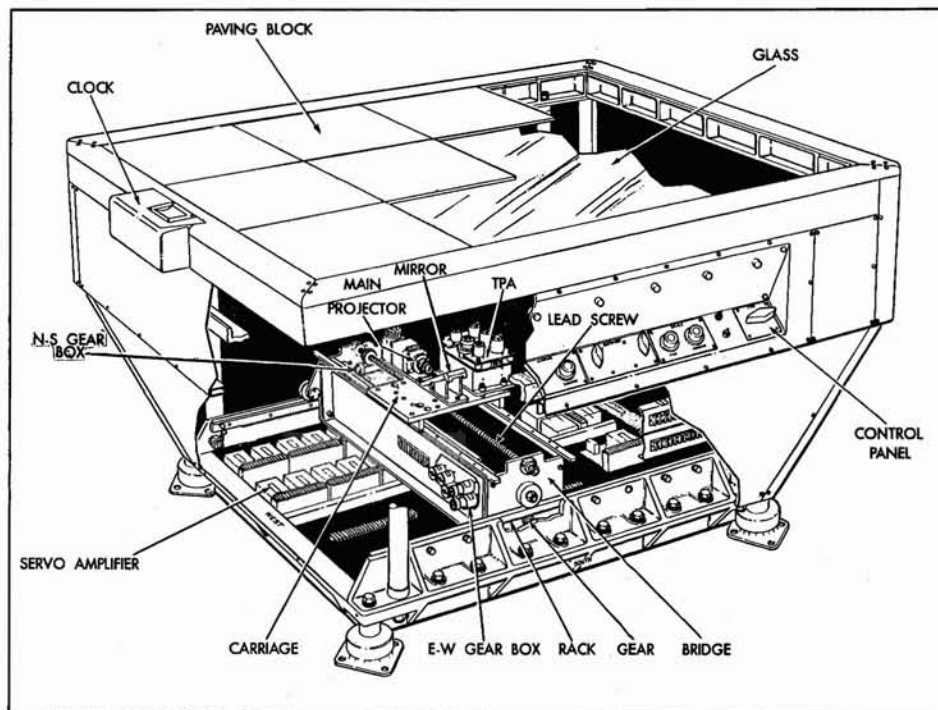

This is one model of the RCN's plotting table, which is about the size of a large office desk. It has a glass top on which rest squares of translucent plastic. The heart of the plotting table is the "bridge" on which is mounted the main projector and two target plot attachment projectors. The bridge moves in an E-W direction on rails and the projectors are movable in an N-S direction. The plot shows the movements of the ship, and two "targets", say, a submarine and a helicopter.

AFLOAT AND ASHORE

ATLANTIC COMMAND

HMCS Bonaventure

After a frigid refit in Saint John, N.B., the *Bonaventure* arrived back in Halifax looking somewhat shabby from her three long months amid snow and ice. A hectic three-week storing and ammunitioning period, mercifully broken by the long Easter week-end, had the ship ready to embark 880 Squadron and depart for the warmer climate of Charleston, South Carolina.

Three days of work-ups and chipping en route removed most of the rust from

the crew and a little from the ship. The flight deck had suffered considerably from the rigours of winter, and an afternoon was set aside for an Open Invitation Chipping Match, when blisters and small mounds of paint scale grew proportionally.

The ship entered Charleston on a bright sunny morning and crept rather apologetically past rows of immaculate American ships to Pier Kilo, where an immediate start was made on the task of painting her overall.

The weather was hot during the next two weeks but, amid sweat, toil and Number One's tears, the ship lost

her grime and rust, and emerged looking resplendent and respectable once more. Considerable wrathful indignation was aroused among the crew at one stage because a paper from back home had announced that the ship was in Charleston for "rest and relaxation". This had cocked the eyebrow of the average Navy wife who had been receiving paint-stained letters telling tales of sweat, sunburn and blisters.

Just for the record, there is nothing relaxing about painting an aircraft-carrier!

Towards the end of the stay the ship was prepared to go to Haiti but the crisis died down and the qualifying of pilots in deck landings carried on.

After a week in Halifax the *Bonaventure* sailed again for exercises with the Fifth Squadron, and it was on the second day of these that the CS2F Tracker crashed into the sea tragically taking the lives of Lt. D. F. Matheson and PO R. A. Hammer.

A proportion of the remainder of the exercise was spent mournfully hooting around in the inevitable fog banks looking for warm weather both inboard and out but the exercises were successfully concluded and the ship returned to Halifax on June 22.

NAVAL DIVISIONS

HMCS Hunter

Lt.-Cdr. Dalton E. Charters, commanding officer of HMCS *Hunter*, the Windsor, Ontario, naval division, has been promoted to acting commander, effective July 1 of this year.

Cdr. Charters, who has been commanding officer at *Hunter* since May 30, 1961, when he succeeded Captain William G. Curry, has been active in naval life since 1948. At that time, as a freshman at Assumption University he joined the second class of University Naval Training Division cadets for instruction at *Hunter*.

In September 1960 he became executive officer of the Windsor division.

A lawyer in civilian life, Cdr. Charters is a member of the firm of Donaldson, Charters and Brockenshire. He is married to the former Pierrette Lanoue.

While at university, Cdr. Charters remained with the UNTD and was com-



missioned at *Hunter* as a sub-lieutenant following his graduation. He then attended Osgoode Hall and entered private practice on graduation, retaining his connection with the naval reserve.

HMCS *Scotian*

The annual inspection of HMCS *Scotian*, the Halifax naval division, took place on May 27 at divisional headquarters in the Mine Base by Point Pleasant Park.

Inspecting officer was Captain Murray A. Davidson, Chief Staff Officer to the Commanding Officer Naval Divisions.

More than 100 officers, men and wrens were on parade. Three reserve personnel were awarded the Canadian Forces Decoration, Chief Petty Officers H. B. Cleveland and J. C. Anderson and PO K. F. Eisan.

For *Scotian* this is the 40th anniversary year as a naval division, since she was one of the original 16 set up across Canada in 1923. There are 21 today, from St. John's, Newfoundland, to Prince Rupert, B.C.

HMCS *Malahat*

A double winner of HMCS *Malahat's* divisional prizes for the past training season at the Victoria naval division was AB B. H. Wilby, who won first prize for seamanship and first prize for sports.

Ord. Sea. C. R. Dawson won the Captain G. A. V. Thomson trophy as the best new entry. Ord. Sea. L. E. Thomas won the communications prize and Ord. Sea. W. C. Warren the prize for the best kit.

AB K. Sturmev won the award for other professional subjects.

The Captain Jackson trophy for the most proficient division in *Malahat* was won by General Training IA class, whose divisional officer is Sub-Lt. D. Walton.

SEA CADETS

RCSCC *Columbia*

The fourth annual inspection of RCSCC *Columbia*, Aldergrove, B.C. by Cdr. J. W. McDowell, came as the climax to an exciting year.

E. D. Stone, president of the B.C. Mainland Division of the Navy League, presented the R. J. Bicknell proficiency trophy to the corps for the third successive year. In addition, *Columbia* has been awarded the *Powell River News*

trophy as the best all-round corps in the Pacific area and Able Cadet P. Irons received the Assistant Area Officer's dirk for obtaining the highest pass mark in the Pacific area in the leading cadet paper.

During the Lower Mainland Junior Tattoo in May, *Columbia* provided a royal guard for the Lieutenant Governor, Major General G. R. Pearkes, VC.

Part of the ceremonies was the presentation of fanfare trumpets from

youth groups in the Fraser Valley to the Royal Canadian Engineers band. PO T. Metcalfe, of *Columbia*, Canada's Sea Cadet of the Year, made the presentation.

To round off the year, *Columbia's* regatta crew of Able Cadet E. Mackenzie and Able Cadet F. Carstensen were selected as the result of elimination trials to represent the B.C. Mainland Division at the National Sea Cadet Sailing Regatta in Vancouver in August—J.R.T.



Navy League Cadets stow personal gear in HMCS *Crescent* at the start of a cruise from Halifax to Lauzon, Quebec, July 12-15. CPO Cadet Gary Rafter and Cadet Paul Heerebot were among 15 Micmac Corps cadets embarked as the destroyer escort headed up river for refit. (HS-E2560)



The destroyer escort *Sioux* in early July played host at Hamilton to 480 children of YMCA clubs in the Galt area. Shown is a group of Preston children with their club counsellor Miss Barbara Michener, of Preston, and their tour guide, AB Keith Godwin, formerly of Preston. (COND-8581)

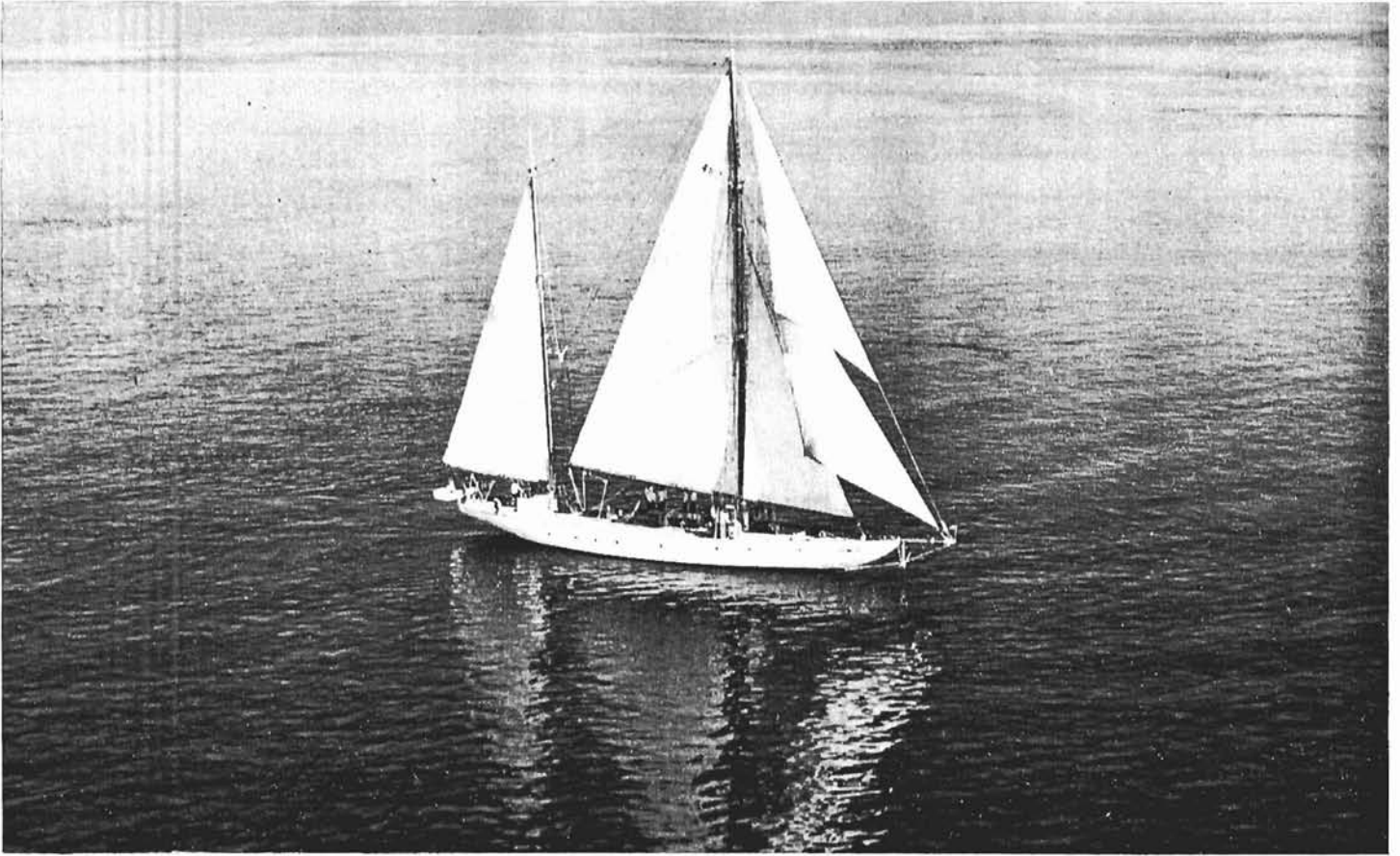

SWIFT BUT NOT SURE

By

John Andrews

Staff Reporter,

The Vancouver Sun

The Admiral summed it up very nicely.

"Gentlemen," he told the sunburned group clustered around the *Oriole's* wheel, "we are about to make our grand entrance".

Then things began to happen with startling suddenness.

Pushed by a strong following wind and sea, the *Oriole* lifted to a surging 12 knots. Her straining spinnaker pole began an almost unbelievable whipping bend to starboard.

Skipper Bill Walker quickly ordered all hands aft. A moment later, a guy snapped. The huge white spinnaker split with a loud crack as air tore through a hole in its 6,600 square-foot surface.

With the remains hastily cleared away and more sail hoisted to take its place, the *Oriole* swept through Race Rocks Passage.

She made the finish line just 35 hours after a dull, dead-calm start the day

before. It was a start that lost her the race even before she eased achingly across the starting line, bound on a 136-mile run in the 1963 Swiftsure.

I first went aboard the *Oriole* as she lay alongside in Victoria harbour the night before the start.

Trim and neat, she looked a winner as she bobbed lightly beside the other flag-draped yachts.

The Author

Like people in other professions, sailors often cannot see the woods for the trees and it's refreshing to have someone drop in from outside once in awhile to point out what is really going on. In this instance, the visitor is John Andrews, marine editor of The Vancouver Sun, who underlines what her fans have always said, that given half a chance, the Oriole could win the annual Swiftsure classic (which she has invariably lost) in a walk.

I went below and met the most important men aboard. The first was Bill (Lt.-Cdr. W. D.) Walker, the *Oriole's* captain.

Looking absolutely fit and brown as a native, he flashed a grin and gave me the run of the ship. "You're port watch," he told me, as he passed over the crew list.

While I had a look at it, Bill left to wish *bon voyage* to the other skippers and it was then I ran into important man number two.

"Who are you?" he demanded.

"A reporter," I mumbled, meekly.

"Well, I'm the ship's cook," he said. "And that's my galley. In there, I'm the boss!"

I didn't argue and so, assured he was still in command, Benny Theriault, leading seaman, Cape Bretoner, and "the best dam' cook in the navy", decided I would do.

It was the start of the best friendship my stomach ever had.

At dusk, the *Oriole* slipped for Esquimalt and once alongside, the crew removed as much gear as possible to lighten ship.

Before turning in, I was told by a grinning group that I had been assigned a hammock at sea.

Cox'n Dave Ferguson (wearing the biggest grin of all) had also neatly arranged another hammock for *Sun* photographer Brian Kent.

The other civilians aboard, Verne Vosper, a tide and current expert and tug skipper, and John Seale, CBC photographer, drew bunks.

On race morning, long faces all around.

We had a flat calm. No wind, an inbound tide, and a crowded pack to play who-gets-to-the-line-first with.

The gun caught the *Oriole* flat-footed. Well astern of the line, she just managed to ease her bow up to the marker ship, the frigate *Beacon Hill*.

Then she began to slip rapidly astern.

Bill Walker could do nothing. He tried everything. Different sails; shifting weight; muttered threats; pleading promises. We just sat there, sullen and unmoving, our anchor holding us off the nearby shore.

It was while Benny was pumping us full of his waist-bulging food, almost three hours later, that Bill made a dramatic move.

He was the first of about two dozen becalmed skippers to sense a change in the air. Quickly, he ordered all hands on deck.

We began to run the heavy anchor chain aft. More than 200 feet of it was down and as we grunted and groaned our way along the deck, Bill hoisted his spinnaker and mizzen staysail.

Both light nylon, they caught, filled cautiously and with slight way on we crossed the line.

The air stayed light for another two hours, however, and by the time we reached Race Rocks Passage, the lead boats were five hours ahead.

It seemed our big 90-footer had not even the slightest chance of overtaking.

With Rear-Admiral E. W. Finch-Noyes, (Ret), spelling Bill Walker at the helm, we held council.

What wind the *Oriole* had was contrary. To get any distance she would have to beat her way in short legs up Juan de Fuca Strait.

She was at a great disadvantage. For the *Oriole*, in spite of her great spread of canvas, just can't point into the wind.

As she smashed her way through a now growing sea, Bill decided to tack her well out toward the American shore, then beat back and so on, all through the night.



We did have prospects of freshening wind; that at least gave us hope of catching a good part of the fleet, still well ahead.

As dark came, we were alone. Long reaches had taken us over many miles of water. But we had gained little over the true course.

Still, the wind was holding. With *Oriole's* great sail, we might make up a good portion of our lost time.

I managed (without aid of seamen or "mick sticks") to sling my hammock and turned in.

When the middle watch was called, you could feel the change. A heavy sea rolled the *Oriole* with complete disregard for crew and crockery.

Stinging rain lashed us and we were ordered to wear life jackets and step carefully.

I found a cosy corner aft near the mizzen and talked over our position with the Admiral, who had taken the helm.

The *Oriole* was doing well, he said. The more wind the better. The bigger the sea, the easier for her; the harder for the smaller boats.

We'd make the Swiftsure mark by mid-morning, the admiral reckoned.

He was right on the button. At 10:30 a.m. we slipped round the anchored frigate and began the haul for home.

Before we made the mark we saw the lead boats shoot past with all sail flying. The *Adios* was well out in front with most of the pack about an hour astern of her.

Once the *Oriole* had the following wind she acted like an express train; spinnaker drawing like a cloud, she shot away.

By mid-afternoon, she had overhauled a dozen boats. While passing through Race, she was drawing a bead on half a dozen more. That's when her spinnaker let go.

The *Oriole's* time over the homeward leg was 10 minutes faster than that of the first boat to finish. With help, she can do even better.

She needs a deeper keel. Then Bill Walker can dump 10 tons of ballast and point her much higher. The *Oriole* also needs new sails. All this costs money.

How can she get them? Simple: every man in the navy chips in with a minimum 25 cents. No red tape. No government money problems. The navy takes care of its own.

And why? Well, in years past, most West Coast yachtsmen were inclined to laugh loud and long whenever the *Oriole's* name was mentioned.

Seems she usually finished last, if she finished at all.

The *Oriole* has a cracker-jack crew and a fine captain to lead them.

It's time the laughing stopped.

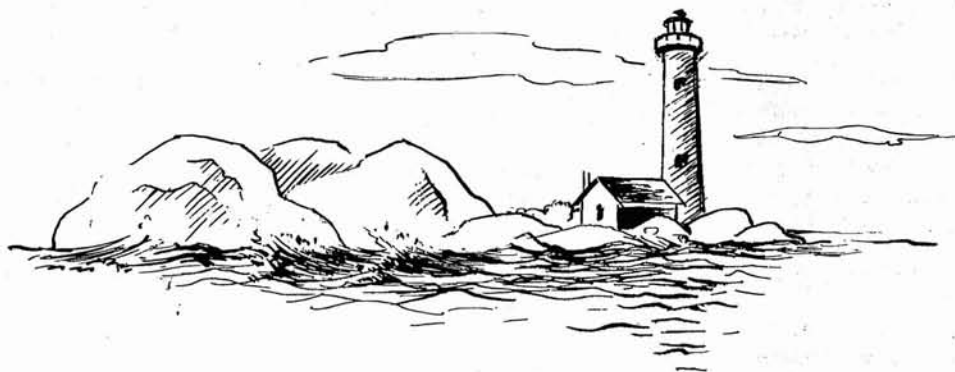

'POLISH'D MANNERS AND FINE SENSE'

AT A MILITARY funeral the casket is always carried feet first, except that of a clergyman, which is carried head first.

This interesting and occasionally useful rule is laid down in *Service Etiquette*, by Captain Brooks J. Harral, USN, and Oretha Swartz, the second edition of which, with revisions, has just been published by the United States Naval Institute.

Etiquette is a codification of the conventional rules of behaviour in a culture and is not quite the same thing as good manners, although both tend to reduce friction and avert conflict among people. Thus a person can be letter perfect in etiquette and at the same time a complete rotter. This is hardly possible in the case of a person possessed of natural good manners.

Nevertheless, a knowledge of the etiquette and customs of the area of society in which one finds oneself can smooth one's path through life and, in the services—and, as Kipling might put it, show the way to promotion and pay.

Although it is written specifically for the Armed Forces of the United States, *Service Etiquette* contains much that is valid for persons serving in the Royal Canadian Navy (and their wives) and also much to guide the steps of those

BOOKS for the SAILOR

who are not in uniform. It is, in fact, a text-book of good manners and social customs of broad application and one that can save those who have access to it from frequent bewilderment or embarrassment.

The nine sections of the book are entitled: "Manners and Dress", "The Social Side of Life", "Your Table Manners" (including hints on toasts and tipping), "Entertaining", "General Correspondence and Invitations", "Easy Conversation" (introductions and farewells, and good manners before an audience); "On Your Own" (going to the theatre, reserving hotel accommodation), "Strictly Service" (saluting and other service customs) and "Personal Matters in Everyday Life", wherein guidance is given concerning service weddings and funerals.

Although his rank is given as captain, the male co-author, Brooks J. Harral, is actually a retired rear-admiral who formerly headed the Department of

English, History and Government at the U.S. Naval Academy. As a submariner in the Second World War, he was awarded five major medals. The other co-author, Miss Swartz, is a former newspaperwoman.—C.

SERVICE ETIQUETTE, by Captain Brooks J. Harral and Oretha D. Swartz; published by the U.S. Naval Institute, Annapolis, Maryland; 447 pages; \$6.

GUERRILLA WARFARE

NATIONS, despite all the atom rattling that goes on, have no desire to fight a nuclear war and, for that very reason, lesser forms of conflict—although they may be just as final for the individual participants—are the more likely to occur.

Thus, in today's world, we have refinements of the arts of blackmail, economic pressure and, when the going gets rough, guerrilla warfare.

Suppressing partisan guerrillas is a tedious and costly, but not impossible, process, as the successes of the British in Malaya and of the regular army in Greece proclaim. The lessons of the 12-year-long British campaign are being applied, with modifications, in Vietnam today.

Over the past three years the *United States Naval Institute Proceedings* has published a number of articles on various aspects of guerrilla warfare. These studies have been assembled in a paperbacked volume entitled *Studies in Guerrilla Warfare*. For the most part these articles deal with land operations but attention is drawn to the kinship of human torpedo and inshore mining forays, and other restricted-water operations.—C.

STUDIES IN GUERRILLA WARFARE, published by United States Naval Institute, Annapolis, Maryland; 100 pages, illustrated; \$2.50.

New Catalogue Of Match Books

A revised listing of HMC Ship's book matches has been prepared by Patrick E. Griffiths, 30 Callie Road, Hamilton. A limited number of copies are available and may be obtained by serious collectors from Mr. Griffiths without charge.



Lt.-Cdr. Alan Easton, RCNR (Ret), author of the successful "50 North", was speaker at a meeting of the directors of the Montreal NOAC branch at the Bluenose Inn restaurant in Place Ville Marie recently. Here are Eric Harvey, president of the Montreal Naval Officers' Association, Lt.-Cdr. Easton and Ron King, a director of the association. (Photo by Business & Industrial Photographers Ltd.)



MEMORIAL TO 'MAGGIE'

UNUSUAL carved wood panels were unveiled in Our Lady of Fatima Roman Catholic Church at Shannon Park on the noon of June 22.

Commodore M. A. Medland, Commodore Personnel Atlantic Coast, unveiled the panels in the Sanctuary of the church. Our Lady of Fatima is one of two churches in Shannon Park administering to the spiritual needs of the naval married quarters population.

The panels were carved by Quebec sculptor Médard Bourgault and are a gift of the ship's company of the former HMCS *Magnificent*, aircraft carrier which preceded HMCS *Bonaventure* in RCN service.

Father Régis Pelletier, Roman Catholic Chaplain, who was responsible for the panels being produced, said that a bronze plaque recognizing the gift will be placed in the church.

Positioned on each side and over the altar, the panels depict religious scenes which are significant to the members of the church. The panel on the right side depicts the "Storm at Sea", in which Christ is shown asleep in the bow of a boat having some resemblance to a naval whaler.

The left panel depicts Christ receiving children, whose garb suggests naval dependents. In the background is the likeness of one of the latest RCN destroyer escorts.

Over the altar is a carving of "Our Lady of Fatima".

Each panel measures six feet by six feet and is up to three inches in depth. The artist carved the panels from Canadian pine.

Father Pelletier said that the gift of money from the *Magnificent* had been

held in trust since the ship was returned to the Royal Navy in 1957. He said that the money had been given from the carrier's canteen profits to erect a commemorative of the *Magnificent* in the church. Several ideas were considered over the past few years but none, up to the wood carvings, seemed to fit the need.

Chaplain Pelletier noted that the wall behind the altar was rather barren. He felt that if this wall were replaced with a wooden face containing wood carvings, the chapel's appearance would be enhanced.

Subsequently, with the permission of the Flag Officer Atlantic Coast, he engaged Médard Bourgault to make the wall carvings. M. Bourgault took several months to complete the commission. His work was installed in early June.

OFFICERS

Rank	Basic	2 Yrs	4 Yrs	6 Yrs	8 Yrs	ALLOWANCES		
						SUBSISTENCE		Marriage
						Single	Married	
Captain.....	\$899	939	979	—	—	139	165	40
Commander.....	709	734	759	784	809	126	150	40
Lt.-Cdr.....	555	580	605	630	655	113	135	40
Lt.....	428	448	468	488	508	96	125	40
Cmd. Off.....	408	423	438	453	468	95	125	40
	Basic	3 Yrs		6 Yrs				
Sub-Lt.....	331	371		386		90	125	40
Act. Sub-Lt.....	235	—		—		75	110	40
Cadet.....	73	—		—		65	—	—

Medical officer allowances are increased and similar professional allowances are introduced for legal officers.

Qualified aircrew officers engaged in flying duties and officers under training for aircrew qualification receive aircrew allowance at the rate of \$75 to \$150 according to their rank, in addition to regular pay and allowances. Qualified submarine officers, serving in a submarine in commission, receive a monthly allowance of \$75 to \$115, and half those rates when undergoing training or serving in "annotated positions". Non-qualified officers are paid \$30 a month while on casual duty in a submarine.

A special allowance of \$30 per month is paid to naval officers in certain specific appointments.

Subsistence allowance is payable only when rations are not provided and quarters are not available, and is thus not normally applicable to junior officers. Marriage allowance is not paid to married officers under 23 years of age.

MEN

Rating	Basic	2 Yrs	4 Yrs	6 Yrs	ALLOWANCES			Kit Upkeep
					SUBSISTENCE		Marriage	
					Single	Married		
CPO 1.....	\$324	334	344	354	95	110	30	8
CPO 2.....	289	296	303	310	85	105	30	8
PO 1.....	251	257	263	269	85	105	30	8
PO 2.....	219	224	229	234	75	105	30	7
Ldg. Sea.....	195	199	203	207	65	100	30	7
	Basic	Trained	3 Yrs	6 Yrs				
Able Seamen.....	\$138	—	159	186	65	100	30	7
Ord. Sea.....	112	119	—	—	65	100	30	7
Ord. Sea. (under 17).....	60	—	—	—	—	—	—	7

Three new trade pay levels have been introduced, in Trade Group 3—3X, 3Y and 3Z—bringing to six the number of trade groups now in effect. There will be no advancements to the new groups until a current evaluation of all trade groupings has been completed. Trade Group pay is as follows: TG 1—\$12; TG 2—\$36; TG 3—\$54; TG 3X—\$60; TG 3A—\$63; TG 3Y—\$66; TG 3Z—\$72; TG 4—\$72; and TG 4A—\$90. QRCN Art. 204.32 ensures that a promotion or regrouping of a man will not reduce his pay, but that his rate of pay will remain unchanged until the rate of pay to which he subsequently becomes entitled is greater than that which he received before promotion or regrouping.

Qualified aircrew men engaged in flying duties receive flying pay of \$75 a month. Trained submarine personnel serving in submarines in commission receive submarine pay at the rate of from \$65 a month for leading seaman and below and \$75 a month for chief and petty officers. Men undergoing basic submarine training courses are paid at half this rate, as are trained submarine personnel serving in "annotated positions", e.g., spare crew or crews of submarines in refit. An allowance of \$30 a month, all ranks is paid to non-qualified personnel on casual duty in a submarine in commission.

A foreign service allowance is paid for service in ships outside Canadian waters, provided the ship is away for a continuous period of not less than 30 days, at the following rates: CPO1, \$16.50; CPO2 and PO1 \$15; PO2, \$12; Ldg. Sea., AB and Ord. Sea., \$9.

Marriage allowance is not payable under 21 years of age. However a special rate of separated family allowance is payable for men under age for marriage allowance. See QRCN 205.24 para (b).

RETIREMENTS

AWARDS OMITTED

The notice of CPO George Charles Van Der Haegen's retirement on April 3, in the May *Crowsnest*, noted that he had been awarded the Long Service and Good Conduct Medal but failed to show that he had received two operational awards, the Distinguished Service Medal for services in HMCS *Sioux* in 1944, awarded January 14, 1945, and the British Empire Medal, for services in HMCS *Athabaskan* during the Korean War, awarded January 27, 1954.

PO RODERICK ARTHUR BOLT, CD; PIPT4; joined May 21, 1942; served in *Discovery*, *Naden*, *Cornwallis*, *Kamloops*, *Stadacona*, *Orkney*, *Antigonish*, *Athabaskan*, *Cayuga*, *Royal Roads*, *Ontario*, *Sussexvale*; retired July 1, 1963.

CPO GORDON HEWITT, CD; C1ER4; joined July 16, 1942; served in *Discovery*, *Naden*, *Burrard*, *Givenchy*, *HMS Mastodon*, *Stadacona*, *Hunter*, *Peregrine*, *Cornwallis*, *Niobe*, *Warrior*, *Magnificent*, *Churchill*, *Crusader*, *Quebec*, *Iroquois*, *Discovery*, *Beacon Hill*; retired July 15, 1963.

CPO PETER HLADY, CD; C2AM4; joined July 15, 1941; served in Calgary naval division, *Naden*, *Prince Robert*, *Canfisco*, *Star*, *Givenchy*, *Stadacona*, *Hamilton*, *Ettrick*, *Hochelaga II*, *Levis*, *Peregrine*, *Carlplace*, *Niobe*, *Warrior*, *Nootka*, *HMS Gosling*, *RANS Gosport*, *RCNAS Dartmouth*, *Shearwater*, *Bytown*, 18 CAG, *Magnificent*, *Cornwallis*, *Bonaventure*, *VU 32*; awarded CD August 18, 1953 (due July 22, 1953); retired July 14, 1963.

PO ARTHUR REGINALD KEDDY, CD; PIBN4; joined RCNVR May 11, 1943; transferred to RCN Oct. 3, 1945; served in *Stadacona*, *Protector*, *Cornwallis*, *HMS Loring*, *Niobe*, *Arnprior*, *Avalon*, *Peregrine*, *Uganda*, *New Liskeard*, *Iroquois*, *Haida*, *Huron*, *Nootka*, *Porte St. Jean*, *Magnificent*, *Scotian*, *Resolute*, *Bonaventure*; retired July 13, 1963.

CPO GEORGE DUNCAN MacINTYRE; C1CM4; joined July 2, 1938; served in *Stadacona*, *Skeena*, *Arleux*, *Cartier*, *Annapolis*, *Niobe*, *Iroquois*, *Cornwallis*, *Avalon*, *York*, *Cornwallis*, *Shelburne*, *Naden*, *Warrior*, *Scotian*, *Cayuga*, *Ontario*, *Fraser*; awarded Long Service & Good Conduct Medal; retired July 1, 1963.

PO ROBERT CHRISTOPHER MCGIRR, CD; PIET4; served in RCNVR July 15, 1941—Aug. 23, 1945; joined RCN Feb. 18, 1946; served in Calgary naval division, *Naden*, *Armentieres*, *Stadacona*, *Niobe*, *Hespeler*, *Avalon*, *Napanee*, *Scotian*, *Peregrine*, *Tecumseh*, *Givenchy*, *Charlottetown*, *Discovery*, *Antigonish*, *Ontario*, *ML 124*, *Cayuga*, *Stadacona*, *Labrador*, *Gaspé*, *Porte Quebec*, *Athabaskan*, *Saguenay*; retired July 30, 1963.

CPO GUY WALTER STANFORD, CD and 1st Clasp; C1RR4; joined RCNVR May 22, 1940, transferred to RCN Aug. 23, 1940; served in *Stadacona*, *Columbia*, *Montreal*, *Donnacona*, *Hochelaga*, *Cornwallis*, *Niobe*, *Peregrine*, *Warrior*, *Magnificent*, *Naden*; retired July 29, 1963.

CPO FENWICK RAYMOND THOMPSON, CD; C2ER4; joined July 8, 1943; served in *Brunswick*, *Cornwallis*, *Stadacona*, *Niobe*, *HMS Stayner*, *HMS Vernon*, *Loch Morlich*, *Protector*, *Warrior*, *Magnificent*, *Nootka*, *Iroquois*, *La Hulloise*, *Haida*, *Wallaceburg*, *Micmac*, *Penetang*, *Fort Erie*, *Kootenay*, *Columbia*; retired July 19, 1963.



Ships of the Second Canadian Escort Squadron steam over a shimmering tropical sea, down Mexico way, during a training cruise this past spring. (CCC2-1136)

Naval Lore Corner

Number 119 R.N.R. DRILL SHIPS

UNLIKE THE RCNR DIVISIONS ACROSS CANADA WHICH ARE "STONE FRIGATES", MANY OF THE BRITISH RNR DIVISIONS HAVE THEIR QUARTERS IN FLOATING DRILL SHIPS SECURED IN PERMANENT BILLETTS TO BERTHS AND JETTIES...

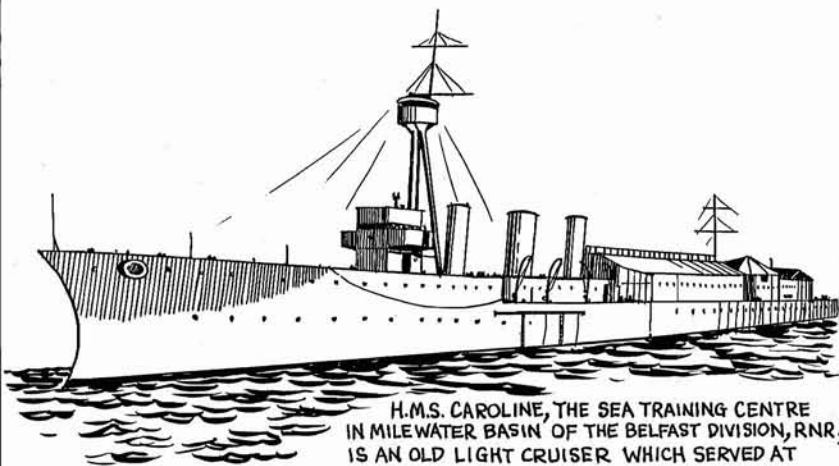

H.M.S. CAROLINE, THE SEA TRAINING CENTRE IN MILEWATER BASIN OF THE BELFAST DIVISION, RNR, IS AN OLD LIGHT CRUISER WHICH SERVED AT JUTLAND AND BECAME A DRILL SHIP IN 1926...

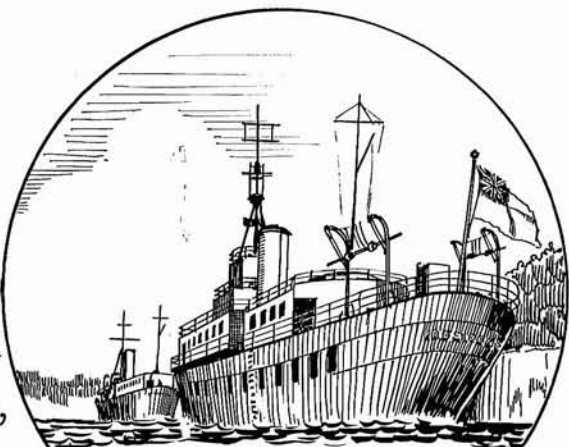

H.M.S. PRESIDENT & CHRYSANTHEMUM - RNR DRILL SHIPS OF THE LONDON DIVISION, SECURED ON THE THAMES EMBANKMENT, WERE EX-FLOWER CLASS SLOOPS BUILT IN 1917 AS Q-SHIPS...

HMS WESSEX (BELOW), THE DRILL SHIP OF THE SOLENT DIVISION, (RNR SEA TRAINING CENTRE) BERTHED AT NO. 14 BERTH, SOUTHAMPTON DOCKS, IS A FORMER SLOOP...

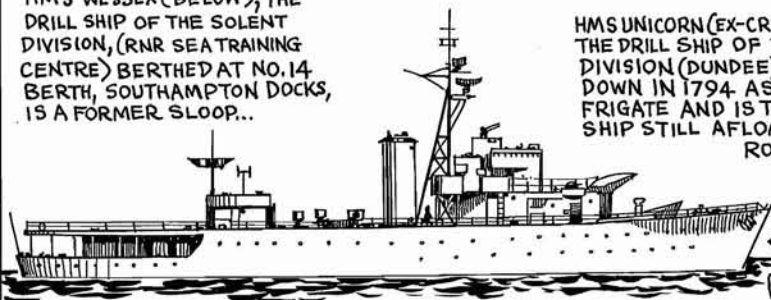

HMS UNICORN (EX-CRESSY) (RIGHT), THE DRILL SHIP OF THE TAY DIVISION (DUNDEE) WAS LAID DOWN IN 1794 AS A 44-GUN FRIGATE AND IS THE OLDEST SHIP STILL AFLOAT IN THE ROYAL NAVY...

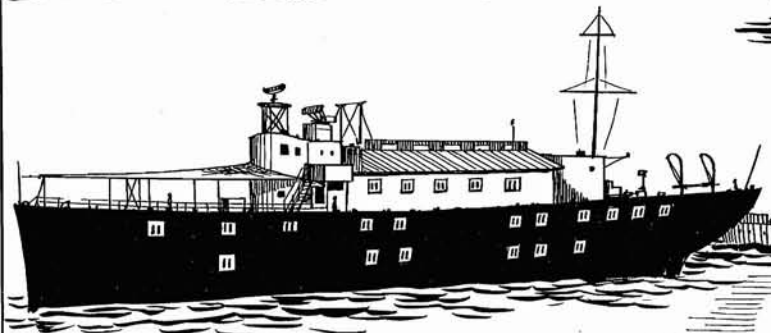

THE SEVERN DIVISION (BRISTOL) HAS TWO DRILL SHIPS. HMS FLYING FOX (ABOVE) IS THE RNR SEA TRAINING CENTRE AT MARDYKE WHARF. HMS LOCUST (UPPER RIGHT) IS AN EX-CHINA GUNBOAT...

HMS LABURNUM (RIGHT) WAS THE H.Q. SHIP OF THE MALAYAN R.N.V.R., SINGAPORE DIVISION. EXTENSIVELY ALTERED IN APPEARANCE, SHE WAS AN EX-2-FUNNELED WORLD WARI FLOWER CLASS SLOOP...

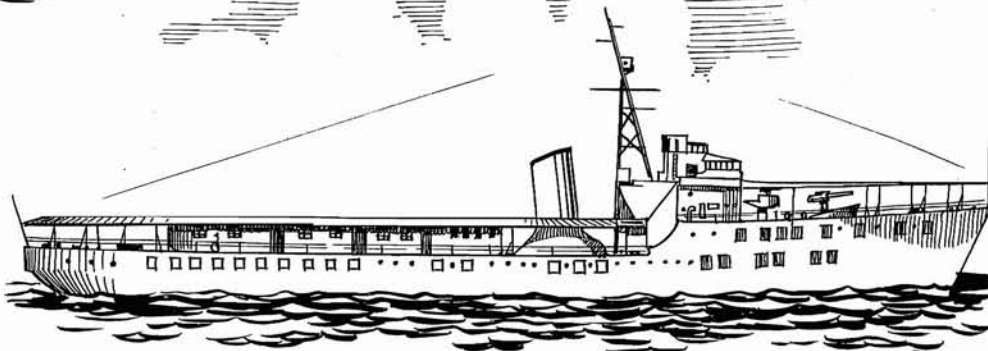

Roger Duhamel

QUEEN'S PRINTER—IMPRIMEUR DE LA REINE

If undelivered return to:

The Queen's Printer, Ottawa, Canada

En cas de non-livraison, retourner à:

L'Imprimeur de la Reine, Ottawa, Canada



The CROWSNEST





The CROWSNEST

Vol. 15 No. 9

THE ROYAL CANADIAN NAVY'S MAGAZINE

SEPTEMBER 1963

CONTENTS

	Page
<i>RCN News Review</i>	2
<i>An Ensign for 'Derry</i>	5
<i>Officers and Men</i>	7
<i>Weddings and Births</i>	7
<i>Assiniboine—First of Her Kind</i>	9
<i>The Last Days of Sail</i>	11
<i>The Laws of the Navy</i>	14
<i>North with the Coast Guard</i>	16
<i>Home from the Sea</i>	19
<i>Promotion</i>	20
<i>The Navy Plays</i>	23
<i>Retirements</i>	25
<i>Lower Deck Promotions</i>	27
<i>Naval Lore Corner No. 120</i>	<i>Inside Back Cover</i>

The Cover—In one afternoon Ord. Sea. Richard Olfert picked up more medals than he could win in a couple of wars by romping off with most of the first places in a new entry track and field meet at *Cornwallis*. Details of his prowess are given in the "Navy Plays" department. (DB-18159)

LADY OF THE MONTH

Fears that the drastic conversion program being undergone by the St. Laurent class destroyer escorts would destroy their sleek appearance have been allayed by the return to service of HMCS *Assiniboine*. Admittedly the twin funnels and box-like helicopter hangar will take a little getting used to—a small price to pay for the vastly increased anti-submarine capacity of the ship.

Commissioned last June 25, the *Assiniboine* has carried out post-commissioning trials in West Coast water before leaving for Halifax to join the Atlantic Command in late October. (E-73279)

Negative numbers of RCN photographs reproduced in *The Crownsnest* are included with the caption for the benefit of persons wishing to obtain prints of the photos.

This they may do by sending an order to the Naval Secretary, Naval Headquarters, Ottawa, attention Directorate of Naval Photography, quoting the negative number of the photograph, giving the size and finish required, and enclosing a money order for the full amount, payable to the Receiver General of Canada.

Sizes, finish and the National Defence standardized prices, follow:

4 x 5 (or smaller) glossy finish only ..	\$.10
6½ x 8½ glossy finish only40
8 x 10 glossy or matte finish50
11 x 14 matte finish only	1.00
16 x 20 " " "	3.00
20 x 24 " " "	4.00
30 x 40 " " "	8.00

SUBSCRIPTION RATE

The Crownsnest may be subscribed for at the rate of \$2 a year; outside of North America, \$3. Orders, accompanied by cheque or money order payable to the Receiver General of Canada, should be sent to:

THE QUEEN'S PRINTER,
Department of Public Printing
and Stationery,
OTTAWA, Ontario

Communications, other than those relating to subscriptions, should be addressed to:

EDITOR,
The Crownsnest,
Naval Headquarters,
OTTAWA, Ontario.



RCN NEWS REVIEW

On September 2, a total of 91 young Canadians arrived in HMCS Venture to begin training under the new RCN Short Service Officers Plan. Just 24 hours after their arrival this picture of Brodeur division, one of four to which the new officer cadets were allocated, was taken. (E-73609)

USN Submariner Flown to Hospital

An ailing submariner from USS *Tusk*, operating off Nova Scotia early in September, was taken by RCN helicopter to the Armed Forces Hospital at *Stadacona* for an emergency appendectomy.

The *Tusk* was 58 miles southeast of Halifax when the helicopter, an HO4S piloted by Lt. Don Neilly, made contact and took the patient on board. He was flown to *Shearwater* and taken by ambulance to the hospital.

Co-pilot was Lt. J. A. DeLisle and crewman was Ldg. Sea. James Dark.

A Pluto Tracker aircraft accompanied the helicopter on its flight. ("Pluto" is a tracker fitted with an inflatable life raft on the wing. Pluto always accompanies helicopter over-water mercy flights.)

Fitness Program Proving Worth

The Royal Canadian Navy late in 1962 announced the introduction of "a planned program of physical and recreational training designed to produce and maintain a high standard of physical fitness among its officers and men." A year later reports indicate the results have been good.

It was recognized that, where once the sailor got ample exercise in the performance of his daily duties, his job in today's technical navy was becoming increasingly dependent on mental ability and manual skills and less on physical prowess. Nevertheless, it was essential that officers and men be in good physical shape, both for the efficient performance of normal duties and to meet emergencies where strength and stamina were pre-eminent.

As a substitute for exercise once automatically obtained, the RCN prescribed for its personnel a program en-

compassing PT, group and individual exercises, instruction in sports fundamentals and organized sports and games. The emphasis was placed on voluntary participation, using naval facilities and equipment and under the guidance of skilled instructors, rather than on formal physical training.

Minimum standards were set and, to determine the level of fitness and ensure the effectiveness of the program, instructions were issued that all officers and men under 40 years of age were to be tested at least semi-annually.

The scheme went into effect last November 1. In the ensuing six months more than 14,500 naval personnel were tested. The results produced some interesting statistics and discoveries:

- Of those tested, 95.4 per cent obtained pass marks.
- At HMCS *Cornwallis*, the RCN's new entry training establishment, 498 recruits were tested in the second week after their arrival. The recruits came from all parts of Canada, their average age was 18½ and 75 per cent had grade nine education or higher. More than one-quarter of them—26.5 per cent—failed.
- After eight weeks of training at *Cornwallis* they were tested

Navy Golfer Sinks Tee Shot

Lt.-Cdr. Michael Thompson, a Canadian naval officer from the destroyer HMCS *Gatineau*, scored a hole-in-one at the Kitzburger Golf Club near Kiel, Germany, in early July.

Lt.-Cdr. Thompson put his five-iron tee shot in the cup at the 165-yard seventh hole. He was playing in a foursome that included Captain C. P. Nixon, Commander of the Fifth Canadian Escort Squadron.

Six ships of the squadron—the *Gatineau*, *Chaudiere*, *St. Croix*, *Terra Nova*, *Columbia* and *Kootenay*—were in Kiel for a five-day visit in the course of a training cruise to Europe.

again. This time none failed. Three quarters easily exceeded the standard and were marked "good" to "excellent".

- Using test results as a criterion, the over-all standard of fitness of naval personnel in the 30 to 39 age group is higher than that of those between 19 and 29.
- An unexpectedly large number of officers and men 40 and over voluntarily showed up for, and often led, PT programs.

All those who failed the tests have since either passed, as at *Cornwallis*, or are exercising "overtime" to bring themselves up to the required standard.

As the over-all physical condition of personnel improves, it is expected the test standards will be raised, to keep pace.

Another possibility is the establishment of minimum standards for the 40-45 age groups, to still the objections of the "over-40s" who took exception to being excluded from the program.

From reports received, it is evident that the Physical Achievement Test has been accepted in the Navy as a challenge, has stimulated interest in personal fitness and has encouraged participation in physical training programs and sports.

Associate Minister Visits East Coast

Hon. Lucien Cardin, Associate Minister of National Defence, visited armed forces establishments on the East Coast in early September.

On his arrival at HMCS *Shearwater* on September 3, the minister viewed a static display of naval aircraft and a model of helicopter "hold-down" equipment.

In the afternoon Mr. Cardin toured the air station and a proposed married-quarters site, before conferring with Rear-Admiral Jeffrey Brock, Flag Officer Atlantic Coast.

The following morning he toured HMCS *Stadacona*, home of the fleet school, the Joint Maritime Warfare School and HMC Dockyard. He also paid visits to the British submarine HMS *Auriga* and HMCS *St. Croix* and lunched on board the *Bonaventure*.

In the afternoon Mr. Cardin was given a briefing on the Canadian Maritime Command Atlantic, then visited Eastern Command Army Headquarters and was briefed by Maj-Gen. R. W. Moncel, General Officer Commanding Eastern Command.

The minister flew by Sea King anti-submarine helicopter on September 5 to HMCS *Cornwallis*.



The down-haul gear (nicknamed "bear trap") which will steady the descent of the Sea King helicopter to the flight deck of the converted St. Laurent class destroyer escorts, is explained to Hon. Lucien Cardin, Associate Minister of National Defence, by Lt.-Cdr. Joseph Sosnkowski. At the left is Rear-Admiral J. V. Brock, Flag Officer Atlantic Coast. (DNS-31693). In the upper picture, Admiral Brock and Captain G. C. Edwards, commanding officer of HMCS *Shearwater* (left), watch the take-off of a CHSS-2 carrying the associate minister and Commodore R. L. Hennessy, Commodore Personnel, Atlantic Coast, on a demonstration flight. (DNS-31706)

Before returning to Ottawa on September 6, Mr. Cardin visited RCAF Station Greenwood, home of the 404 and 405 Argus long-range anti-submarine squadrons.

Changes Made in Senior Posts

Appointments for three senior officers of the Royal Canadian Navy were made in August and September.

Commodore Frank B. Caldwell became Naval Member Canadian Joint

Staff (London), on August 5. He holds the additional appointment of Commanding Officer, HMCS *Niobe*, RCN establishment in Great Britain.

Commodore Caldwell had been Assistant Chief of the Naval Staff (Plans) at Naval Headquarters, Ottawa, since August, 1962.

He succeeded Commodore Angus G. Boulton, who took up the appointments on September 9 of Commanding Officer, HMCS *Naden*, Commodore RCN Barracks and officer-in-charge RCN Depot,

Esquimalt. Commodore Boulton had served in the London appointment since July 1960.

Commodore Morson A. Medland, Commodore Personnel, Atlantic, became Assistant Chief of Naval Staff (Plans) at Naval Headquarters on September 9.

Hydrofoil Given Type Designation

The type designator and hull number "FHE 400" has been allocated to the RCN prototype anti-submarine hydrofoil ship which will be built by The de Havilland Aircraft of Canada, Limited, of Downsview, Ont.

The letters "FHE" stand for "fast hydrofoil escort" and the class has been officially defined as "a ship equipped with hydrofoils, capable of very high speed offensive operations against submarines".

Collar-attached Shirts Approved

The introduction of drip-dry shirts with attached collars for wear by officers, men and wrens in Class 1 uniform has been approved by Naval Headquarters. But it may be a year before they are available.

The new style shirts will eventually replace shirts with detached collars in naval supply as stock sizes of the latter are depleted. They will be worn by officers, chief petty officers, and petty officers 1st class of the Royal Canadian Navy and Royal Canadian Naval Reserve, officers of the Royal Canadian Sea Cadet Corps and wren officers and wrens of the RCN and RCNR.

Because of the civilian trend to shirts with attached collars, the procurement of shirts with detached collars has



One of the happier duties performed by Lt.-Cdr. Aubrey Karagianis before his retirement from the service was his part in attesting his 16-year-old son Gerald Leonard into the RCN, in August. The ceremony took place in HMCS Malahat, Victoria, naval division. At centre is CPO Edwin Moodie, in charge of RCN recruiting offices in Victoria. (E-73173)

become increasingly difficult. Naval personnel also have a laundry problem with detached collars, especially while at sea.

Before selecting a suitable drip dry fabric of Canadian production, user trials were carried out by a group of officers at Naval Headquarters. Shirts made from different fabrics were tested and reported on for appearance, comfort and maintenance.

The material selected is a blend of 65 per cent terylene and 35 per cent cotton which has an excellent minimum care or drip dry properly. The terylene fibres give crease resistance, crease recovery, strength and wear resistance. The cotton fibres give appearance, comfort and moisture absorbency.

The new shirts are the normal RCN style but with attached fused collars and soft double cuffs. As in the past they will be issued gratuitously to officer cadets, men on promotion to Petty Officer 1st Class and to wrens on entry. The issuing of the new shirts will effect a small annual saving as the unit cost is slightly lower than the shirt with detached collar.

The introduction of the new shirt will be gradual until current stocks of the old type are depleted and for a number of years there will be two styles of shirt worn by naval personnel.



Elected a Serving Brother of the Venerable Order of the Hospital of St. John was CPO Evan I. Thomas, a medical instructor at Camp Borden. Formerly attached to the medical division of the HMCS Naden Fleet School, CPO Thomas has been with the RCN since September 1940. An investiture at which he will receive his medal from the St. John order, of which His Excellency the Governor General is Prior for Canada, is scheduled for November 1 in Ottawa. (E-65548-211)

COOKS QUALIFIED FOR MERCHANT SERVICE

THE WAY has been opened for Royal Canadian Navy cooks to go to sea in the merchant service after release from the RCN.

The Minister of Transport has consented to issue a Certificate of Qualification at ship's cook to RCN personnel who have qualified at least to the Trade Group Two level. It is likely that RCN trained cooks who apply will be much in demand.

The possession of the certificate will enable a Cook TG2 or above, on release from the RCN, to apply for a berth as ship's cook in any foreign-going or home-trade merchant ship registered in the British Commonwealth. This broadens the horizons of possible employment to the four corners of the world. This gives a man the opportunity, for example, of entering one of the world's famous shipping lines, or even as serving as chef in a luxurious yacht or cruise liner.

A man of the cook trade who wishes to take advantage of this opportunity should apply through his commanding

officer to Naval Headquarters. Naval Headquarters will check his service certificate and his trade history sheet, and then, if warranted, will apply to the Department of Transport for the certificate.

In order to encourage only those who are actually contemplating a merchant service career after release from the RCN, Naval Headquarters has restricted those eligible to apply to those Cooks Trade Group Two or above who have signified their intention of not re-engaging or to those who are within five years of proceeding to pension.

Authority for applying for this Certificate is contained in NGO 5.00/2 and applications have already started to arrive in Naval Headquarters. So far, all applicants have been in the RCN for a considerable period and are close to retiring on pension. It is interesting to note that although these men have going to sea off and on for up to 20 years, they are still responsive to its lure.

An Ensign for 'Derry

A WHITE ENSIGN worn by the last Canadian warship, the frigate *Lauzon*, to sail from Londonderry, Northern Ireland, following the end of hostilities in Europe in 1945 was presented to St. Columb's Cathedral there on July 21.

Also presented to the Very Rev. L. R. Lawrenson, Dean of Londonderry, to be placed in the cathedral along with the ensign, was a plaque with the following inscription:

"Ensign worn by HMCS *Lauzon*, last Canadian ship to sail from Londonderry, 1945. Presented by the Naval Officers' Associations of Canada on behalf of RCN officers and men who visited this city during World War II and in memory of those who gave their lives in the Battle of the Atlantic."

The ensign was paraded to the cathedral by a colour party from ships of the Fifth Canadian Escort Squadron, at that time participating in exercises

based on Londonderry. Cdr. T. R. Durlley, RCNR (Ret), a past president of the NOAC and president of the Quebec division of the Navy League of Canada, received the ensign from the colour party and turned it over to Rear-Admiral Walter Hose, RCN (Ret), one-time Chief of the Naval Staff, who is honorary president of the NOAC. He, in turn, presented it to the Dean of Londonderry.

During the service of dedication, Rev. Canon Harry Ploughman, RCN, Chaplain of the Fleet (P), preached the sermon. Captain C. P. Nixon, Commander Fifth Canadian Escort Squadron, read the first lesson and the squadron Chaplain (P), Rev. Theodore Fenske, the second. Squadron personnel in attendance included many of the cadet midshipmen from Royal Military College and Canadian universities borne in the squadron's destroyer escorts, the *Chaudiere*, *Kootenay*, *Gatineau*, *Terra Nova*, *St. Croix* and *Columbia*. Also among the 200 naval personnel attending the service were many officers and men who had seen service in the Battle of the Atlantic and who had sailed to and from 'Derry on mid-ocean convoy duty.

Six platoons of officers and men, one platoon from each ship, marched the ensign to the cathedral, with Lt.-Cdr. J. H. Wilkes as parade commander. The colour party was composed of Petty Officers Jack Douglas, Don Mitchell, and Norman Taphouse, and CPO John Orr.

Following the ceremony, Captain Nixon was host at a luncheon on board the *Chaudiere* at which the guests included Rear-Admiral Hose, Sir Basil A. F. McFarland, chairman of the Londonderry Harbour Commissioners, Dean Lawrenson and prominent civic and religious dignitaries.

The presentation was the first of its kind for the Royal Canadian Navy outside of Canada and resulted from an exchange of ideas between the Naval Officers' Associations of Canada and the RCN.

The Londonderry cathedral contains similar tokens of wartime associations with the Royal Navy and the United States Navy.

The ship from which the White Ensign came, the *Lauzon*, was a frigate of the Ninth Canadian Escort Squadron. She was paid off for disposal last May



The colour party bearing the *Lauzon's* White Ensign up the path to St. Columb's Cathedral, Londonderry. (CCC5-657)

24 in Halifax. During the Second World War she was part of the Mid-Ocean Escort Force, assigned to Escort Group C-6.

On June 8, 1945, it has been recorded by the Naval Historian, C-6 arrived in Londonderry with its last convoy. The war in Europe had been over for a month and the convoy system, which had been kept in being for a time in case U-boats, at sea when the fighting ended, refused to surrender, was discontinued during the course of this last passage to the United Kingdom.

Their services no longer required in the North Atlantic, the ships of C-6 left Londonderry on June 13. Records show that the *Lauzon* was the last of the ships to sail.

As the warships proceeded down the River Foyle, the townspeople lined the wharves and banks to give a rousing and heart-warming send-off to this, the last Canadian Escort Group to leave their shores. The ships in harbour had their flags flying and their whistles blowing to cheer C-6 on its way, and aircraft from the Fleet Air Arm and from Coastal Command flew overhead and dipped in salute.

The frigate spent a busy summer in the ferry service instituted between St. John's, Newfoundland, and Quebec City, to return servicemen to their homes without taxing Nova Scotia's port and rail facilities. Paid off in November 1945, she was sold for scrap but was recovered in 1951 and rebuilt as a modernized "Prestonian" class frigate. In this guise, the *Lauzon* gave nine and a half more years of service to the Royal Canadian Navy.

This year's ceremony in Londonderry came toward the end of an eight-week training cruise which took ships of the Ninth Canadian Escort Squadron to Plymouth, England; Kiel, Germany; Copenhagen, Denmark, and Londonderry. The cruise concluded with exercises in conjunction with the British Joint Anti-Submarine School, the Canadian ships returning to Halifax in early August.



The White Ensign worn by HMCS *Lauzon*, the last Canadian warship to sail from Londonderry in 1945 was presented to Londonderry Cathedral by Rear-Admiral Walter Hose, RCN(Ret), a former Chief of the Naval Staff and Honorary President of the Naval Officers Associations of Canada, who is shown presenting the ensign to the Very Reverend L. R. Lawrenson, Dean of Londonderry. At the left are Cdr. T. R. Durlley, RCNR (Ret), president of the Navy League of Canada's Quebec Division, and Lt.-Cdr. P. A. Scott, of HMCS *Columbia*. PO Don Mitchell, a member of the colour party, kneels in the foreground. The dean dedicated the ensign and Rev. Canon Harry Ploughman, RCN Protestant Chaplain of the Fleet, (standing beside the dean) preached the sermon. (CCC5-649)

OFFICERS AND MEN

UNTD Training Conference Topic

The 11th conference of commanding officers of University Naval Training Divisions from across Canada was held at the headquarters of the Commanding Officer Naval Divisions at Hamilton on August 19 and 20.

University Naval Training Divisions from every university in Canada, from Vancouver Island to Newfoundland, were represented and discussions covered all aspects of naval training for UNTD recruits.

The aim of the UNTD is to provide the Royal Canadian Naval Reserve with an adequate supply of trained officers with university education. Suitably qualified young men are selected and enrolled as cadets on entry to university, and receive training during the summer months which will qualify them for a commission in the RCNR.

Commanding Officer Of Scotian Dies

Captain George A. Brown, 46, commanding officer of HMCS *Scotian*, Halifax naval division; died at Camp

Weddings

Able Seaman L. R. Anderson, *Mackenzie*, to Marie Cecile Sanche, of Pinewood, Ont.
Sub-Lieutenant W. G. Buckeridge, *Columbia*, to Stephanie Netherton Jones, of Kingston.

Petty Officer David Campbell, *Mackenzie*, to Maureen Janet Jefferies, of Victoria.

Lieutenant Edward Austin Day, *Scotian*, to Elizabeth Ann McKean.

Sub-Lieutenant Raymond Colin Gamlin, VS 880, to Hillary Elizabeth Dampier, of Vancouver.

Able Seaman W. David Giles, *Fraser*, to Marilyn Maxwell, of North Cowichan, B.C.

Sub-Lieutenant Robert G. Hawkins, *Mackenzie*, to Daphne Arlene Martin, of Islington, Ont.

Ordinary Seaman Ross N. Holsworth, *Fraser*, to Kathleen Hensen, of Alix, Alberta.

Ordinary Seaman Bruce Hyatt, *Mackenzie*, to Fye Beatrice Wallin, of Calgary.

Leading Seaman A. L. Mack, *Mackenzie*, to Carol Elaine Manns, of Firdale, Man.

Ordinary Seaman John Russell, *Mackenzie*, to Lillian Ruby Howard, of Calgary.

Ordinary Seaman Ronald C. Smith, *Fraser*, to Donna Wilson, of Victoria.

Sub-Lieutenant J. Donald Sutherland, *Mackenzie*, to Ann Maureen Ryan, of Ottawa, Ont.

Ordinary Seaman David C. Tyson, *Mackenzie*, to Dorothy Helen Weselak, of Winnipeg.



Allan Simper is congratulated on joining the RCN as a technical apprentice by Lt.-Cdr. A. A. Butchart, as CPO Owen Simper, Allan's father, looks on. The ceremony took place at HMCS *Scotian*, Halifax naval division. (HS-72717)

Hill Hospital Sunday, August 25. His ashes were committed to the deep from HMCS *Cayuga*, following funeral services in all Saints Church, Bedford.

Captain Brown was born in Westmount, Que., and was educated in Montreal schools and at the University of Montreal.

He entered the former RCNVR in October 1935 and took his early reserve training and qualifying courses at Halifax and at sea, gaining promotion to the rank of lieutenant in 1938.

His acceptance for the air branch of the Royal Navy was interrupted by the outbreak of the Second World War and he remained in the RCNVR and was appointed to Naval Headquarters, Ottawa, as signals officer and flag lieutenant to the late Admiral P. W. Nelles, then Chief of the Naval Staff.

In 1940 he took torpedo specialist courses and then served in the destroyers *Restigouche* and *St. Laurent* in United Kingdom waters and in the North Atlantic. He also served in HMS *Rodney* (battle cruiser) until invalided back to Canada in 1941.

For the rest of the war he served in appointments ashore which included executive officer of HMCS *King's*, wartime officers' training school at Halifax, commanding officer of HMCS *Brunswick*, naval division at Saint John, N.B., sea training officer at *Cornwallis*, and staff officer (administration and

training) at HMCS *Hunter*, naval division at Windsor, Ontario.

Demobilized in 1947, Captain Brown went on the active list of the RCN(R) in 1948 and became executive officer of *Brunswick*. He was promoted to commander in 1949 and awarded the Volunteer Reserve Decoration the same year.

He took up residence in Halifax in 1953 and transferred to *Scotian*, as training officer. He was appointed commanding officer in 1958 and promoted to captain in 1959.

Captain Brown was a manufacturer's agent. He was vice-president (Reserves) on the national executive of the Naval Officers' Associations of Canada and president of the Halifax branch of the Navy League of Canada. He served on the board of directors of the United Services Institute.

Captain Brown leaves his wife, the former Ellen Brock, of Rothesay, N.B., three sons, Derek, 18, Brock, 15, and Mark, three, and one daughter Anne, 11.

Births

To Sub-Lieutenant Merlyn R. Bacon, *Mackenzie*, and Mrs. Bacon, a daughter.

To Able Seaman G. G. Buck, *Mackenzie*, and Mrs. Buck, a son.

To Lieutenant Norman Davy, *Mackenzie*, and Mrs. Davy, a daughter.

To Lieutenant-Commander Howard C. Wallace, *Bytown*, and Mrs. Wallace, a son.

To Able Seaman D. E. Wesner, *Mackenzie*, and Mrs. Wesner, a son.

NEW SHAPE - - NEW CAPABILITIES

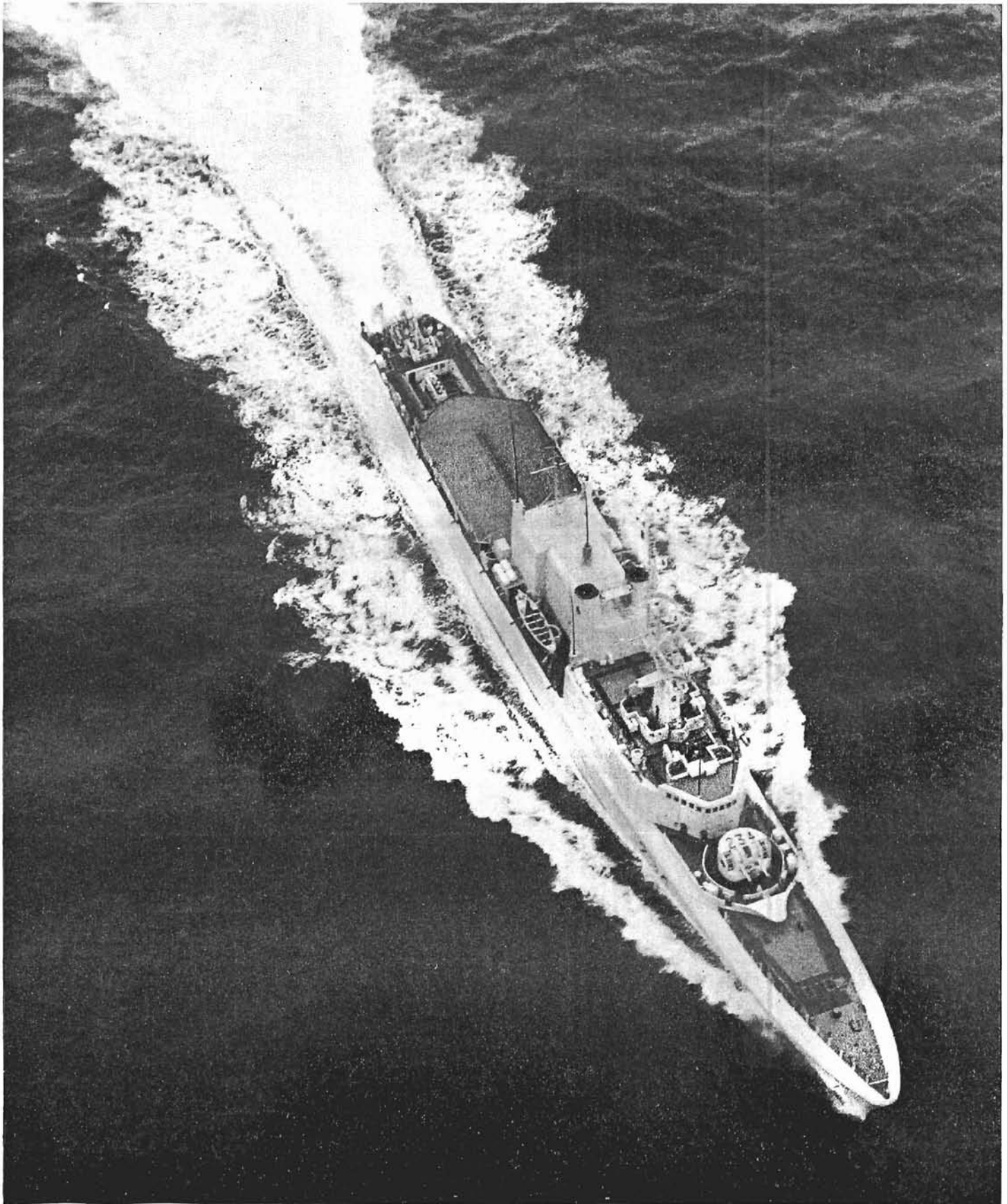

A helicopter's eye view of the Assiniboine taken during trials in West Coast waters. Note the ship's pennant number on the gun shield. (E-73651)

ASSINIBOINE

First of Her Kind

AMAZEMENT and curiosity were dominant in the voice of the person calling the Esquimalt dockyard.

"There's an unusual looking ship... like a little aircraft carrier or something," he exclaimed, "...just off the waterfront... and there's a helicopter hovering over the stern."

Residents of Greater Victoria are used to seeing many interesting and unusual ships. But this was something new and different.

Off the city's shores and into the Strait of Juan de Fuca almost every

day as August ended, HMCS *Assiniboine* was going through a series of post-commissioning exercises.

The radically altered warship is the first of the St. Laurent class destroyer escorts to complete a major conversion to what is, in effect, a new class of ship.

At her stern has been added the massive and revolutionary submarine detection equipment known as Variable Depth Sonar. Its complicated electronic equipment can be lowered deep into the sea to pick up tell-tale traces of an underwater enemy.

Just how drastic the conversion was is indicated in this picture taken in December 1962 which shows her upper deck stripped and her interior partially gutted. (E-69891)

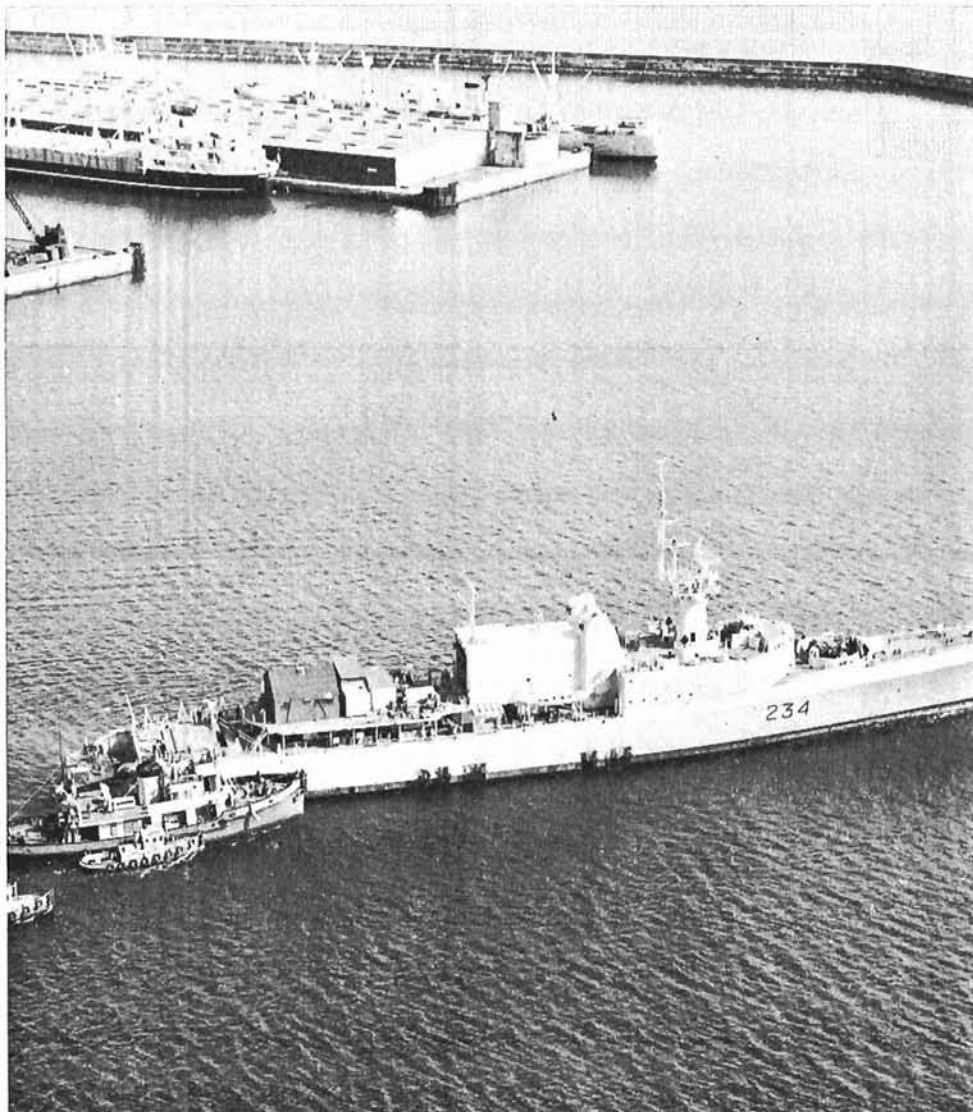
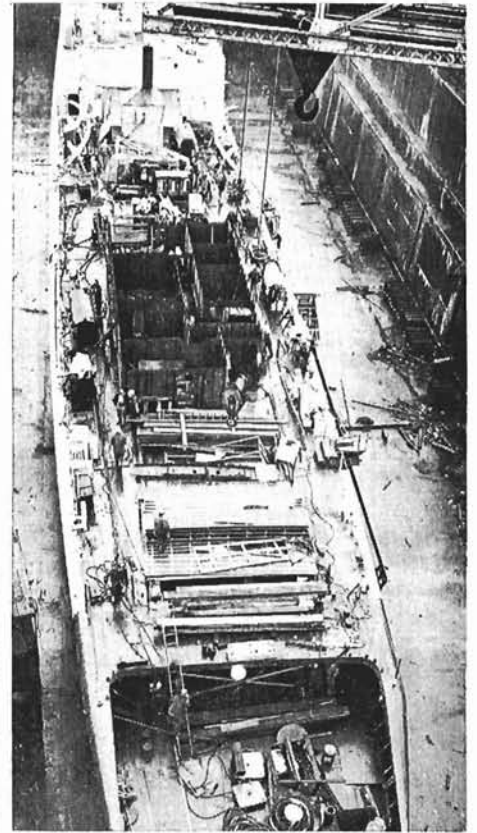

By April 30 of this year, the Assiniboine's conversion was well advanced and she was towed from the yards of the Victoria Machinery Depot Company Limited to HMC Dockyard, Esquimalt, for completion. (E-71937)



HMCS Assiniboine, first of the St. Laurent class destroyer escorts to undergo drastic conversion to what is essentially a new type of warship, has her new flight platform tried out by a Vertol helicopter. (E-73280)

And her superstructure has undergone a tremendous facelifting. Amidship there is a large helicopter hangar, and abaft of that a flight deck. Twin funnels are another major change in the ship's appearance.

Conversion of HMCS Assiniboine was no little task. Over a period of 14 months the shipbuilders and experts of Victoria Machinery Depot Co., Ltd., and the RCN, worked long and hard to convert the warship into her present image. It meant practically stripping everything in the ship above the upper deck from amidship to her stern and starting all over again.

The big conversion job incorporated a number of additional changes and improvements. The ship now has a larger and better equipped recreation space located forward; and there is increased space in all mess decks. Other compartments have been modified and improved.

There are seven St. Laurent class destroyer escorts with the Pacific Command. The same major conversion now completed in the Assiniboine has also been finished in the St. Laurent, and initial work has started in the Saguenay, Ottawa. To follow are HMCS Ships Margaree, Skeena and Fraser.

HMCS Assiniboine was the first, the lead ship. She has been assigned to the Atlantic Command where she will be equipped with the RCN's new anti-submarine helicopter, the CHSS-2 Sea King.

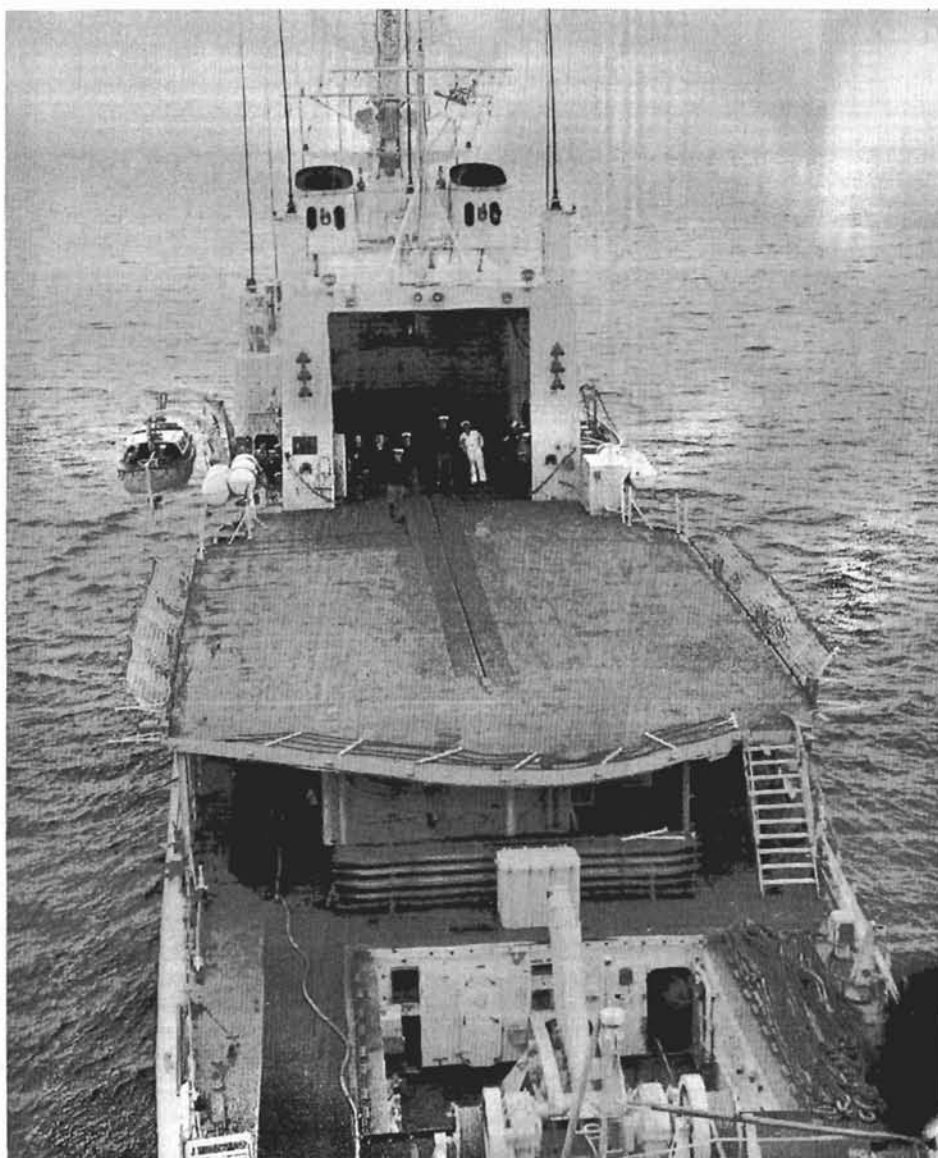

This is a 'copter-eye-view of the converted Assiniboine in which such new features as the variable depth sonar winch, triple-barrelled anti-submarine mortar (there used to be two sets of mortars) and the athwartship twin funnels can be seen. The slot in the flight deck is to accommodate the "Bear Trap" or down-haul winch, which will steady helicopters landing on a pitching deck. (E-73287)



THE LAST DAYS OF SAIL

Part Five

THERE IS a story in the navy that the sailor King William IV when inspecting the fleet, noticed a man with a button missing and asked why. The rating insisted that the men had no time to repair their clothes, whereupon King William is said to have ordered that one afternoon a week, preferably Thursdays, should be given over to repairing clothes.

I imagine that if in real life a man in those days had spoken at a royal inspection in such a way, he would have ended up on the yard arm but the fact remains that in my day Thursday afternoon was the official time to "make and mend clothes". Many sailors had their own sewing machines and up on deck they would come. Others would spend their time embroidering handkerchiefs, carving ship models, putting models into bottles, mending boots or cutting each other's hair. It is not for nothing that it has been said that Jack Tar was a handy man.

We also had our amusing moments. Once when I was sentry of the lifebuoy at the stern of the ship I saw what I thought to be a sea serpent. There could be no doubt about it for it was a warm sunny afternoon. I was about to report to the officer of the watch when I noticed that he too was looking intently into the water. The "sea serpent" turned out to be nothing more than a school of dolphins disporting themselves in single file. When one submerged, another immediately took his place. At least it was more real than the Loch Ness monster, for although it was not a sea serpent it was plainly there for anyone to see. And once during the middle watch the ship hit a sleeping whale. There was a big lurch and we thought we had struck an uncharted shoal. As the ship rode over the huge mammal, it let out an enormous yell. The *Egeria* was undamaged. What happened to the whale I do not know.

The *Egeria* was the only ship in port when Queen Victoria died on January 22, 1901, the fleet having sailed south on the annual post-Christmas cruise. We were housed-in as usual and serving as guardship at Esquimalt. Even at that long distance from home, everyone felt a sense of personal bereavement. The Queen had reigned for so long and done so much good in the 64 years she was

on the throne that it was impossible to realize that she was dead. I confess I was near to weeping when I heard the news. I had only seen her once, and then only her back, when as a boy of 15 my mother took me to see the Diamond Jubilee Procession at St. Paul's Cathedral. She was then a frail, lonely old woman but still stalwart enough to rouse the nation in the blackest days of the subsequent South African war which, incidentally, was still going on.

By
Arthur Walpole

I AM STILL old fashioned enough to regret the good things of the Victorian age, when children held their parents in respect, when men were proud to do a full day's work, when we were not at the mercy of shop stewards and when a pound was worth 20 shillings. True, there have been many improvements since then, better housing, better schools, better wages. But general emancipation has brought perhaps worse evils in its trail such as youthful hooligans, the menace of the teddy boy and the beatnik and juvenile delinquency on a scale never known in history. But that is as may be.

When the old Queen died our gunner was in his element. The *Egeria* being

the only ship in harbour, we had to fire an 81 minute-gun salute, one for each year of the late Queen's life. The two 20-pounder guns were mounted on wooden carriages, trained right and left by means of handspikes and loaded by unlocking the breach and lifting the vent block out from the top to permit the charge to be rammed home. The vent block was then replaced and a quill friction tube fitted into the vent hole, the gun being fired by lanyard.

I was told off to hold a shovel over the vent block to prevent sparks from setting the awning on fire but the force of the blast blew the head of the shovel right through the canvas. It upset the routine a bit but the next round went off at the right moment, the awning being triced up out of the way.

I became an ordinary seaman on my 18th birthday and my pay became 1/3d a day. I felt like a millionaire. The Admiralty was not very generous in its remunerations in those days. The pay of an able seaman was 1/8d. You got an extra penny a day after three years service if you qualified for a good conduct badge. You could get another one after eight years and a third after 13, but only if you elected to serve for another 10 years to qualify for a pension.

ALTHOUGH our primary purpose in the *Egeria* was surveying, we also had to carry out the evolutions of a regular man-of-war. From time to

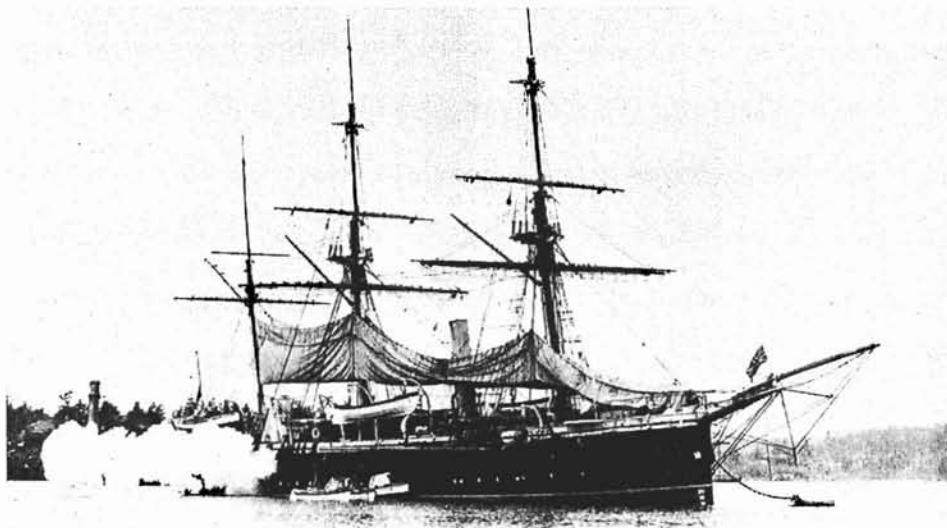

This picture, showing HMS *Egeria* firing minute guns on the day of the funeral of Her Majesty Queen Victoria, appeared in the November 1961 issue of *The Crownsnest*. In the accompanying account of his experiences on board the ship, Mr. Walpole tells how the awnings came to be in the disordered state shown. (E-40018)

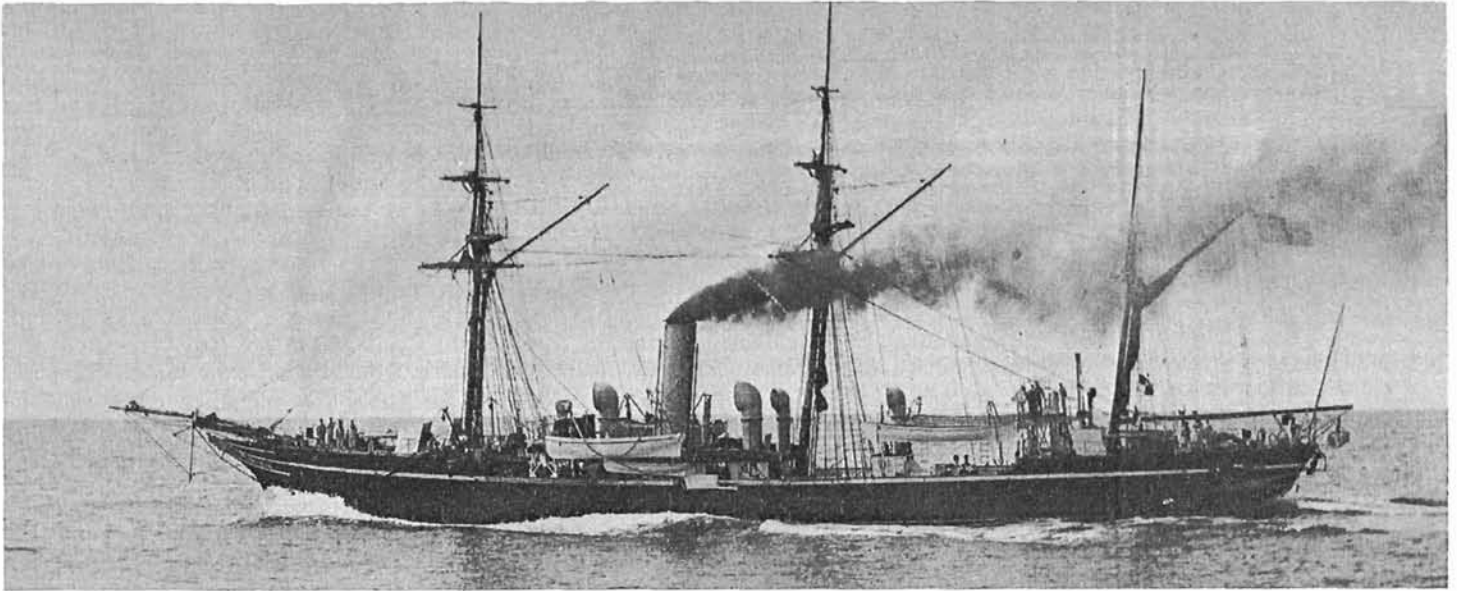

One of the mysteries of Canada's West Coast was the disappearance in December 1901 of HMS Condor, which sailed from Esquimalt for Honolulu and never arrived. Her fate has been linked with that of the U.S. collier Manhattan, also lost with all hands around the same time. It is thought the two ships were sunk by collision off Cape Flattery. (E-40014)

time there was the order, "Clear ship for action", later changed to "General Quarters". Then all hands went to action stations at the double. The two 20-pounders were cast loose and run out by means of tackles, with the gun trainer ready with his handspike at the side of the carriage and the captain of the gun on his haunches looking over the tangent sights. The two machine guns on the poop were manned and the marines drawn up ready to fire at the helmsman of an approaching enemy ship. And there were others with fire arms at the fore and main tops.

Decks were wetted and sanded, fire hoses rigged and pumps manned. Cutlasses were issued for boarding parties and pikes held in readiness to repel boarders. The pikes I remember were hefty affairs eight feet long and, as they were carried at the trail, it was the deuce of a job to avoid prodding the men in front in the buttocks.

Whips were rove at the yard arm to hoist buckets of water to the fighting tops to put out any small fires which might damage the sails. The wheel was double manned and the boom deck cleared of all spare gear. Everything that could float was lashed so that it could easily be thrown overboard and retrieved when the action was over.

The daymen formed a stretcher party under the surgeon's orders to carry wounded to the orlop deck. The galley fire was doused to obviate danger. Even if the exercise was carried out light-heartedly it was the same as if we were actually going into battle.

One thing every man on board could do and that was shoot with a rifle. We had intensive annual practice on the range at Esquimalt. It lasted for three days and we shot at stationary and moving targets. There was also snap shooting with targets appearing all over the place. And there were prizes for the best marksmen based on points of the scores made.

WHILE I was stationed at Esquimalt there was a tragedy in the Pacific fleet—the loss of the *Condor*. Like the *Shearwater* and *Icarus* of the same class, she was commissioned at Chatham on November 1, 1900, and, after fulfilling other duties, came to Esquimalt by way of Cape Horn. It was then the custom of the navy for men of the same rating to exchange to another ship if they wanted to and could find a substitute, and unhappily one or two of our men went from the *Egeria* to *Condor*.

As I have said, the *Condor* was one of our three sloops and on December 2, 1901, she sailed for Honolulu on a courtesy visit. She ought to have arrived on the 15th. But no more was heard of her and when she was reported overdue, the *Egeria* was sent in search. We were forced by bad weather to put into a place called Clayoquot and were out of touch with the outside world for some days, being in turn reported overdue.

My father was editor of *Hansard* at the time and he persuaded a member to ask a question in the House about

the tragedy. It was reported in *The Times* on February 11, 1902 as follows:

Mr. MacNeill (Donegal S.) asked the Civil Lord of the Admiralty whether the Admiralty had received any news in confirmation, or otherwise, of the disaster which was reported to have happened to the *Egeria* which went in search of the *Condor*?

Mr. Pretyman (Suffolk, Woodbridge). No, sir, the Admiralty have no reason to suppose in any way that anything has happened to the *Egeria*. The *Egeria* is not expected to be heard of for two or three weeks.

Two days later *The Times* reported:

"The Admiralty yesterday received the following telegram from Commander C. H. Simpson, of the *Egeria*, surveying vessel: Boat found at Ahouset is *Condor's* dinghy. Following is list of government stores found at Long Bay—a detailed list was given—'all from the upper deck'."

A further report stated:—

"Lloyd's agent at Vancouver, B.C. telegraphed yesterday as follows: The *Egeria*, returned, was aground at Clayoquot, but was afterwards got off undamaged and proceeded. Reports having picked up a piece of spar recognized as belonging to British gunboat *Condor*. Has boat previously reported on board."

The *Phaeton* which was also engaged in the search followed the course the *Condor* should have taken down the coast as far as San Francisco but found nothing.

On March 17, the Admiralty abandoned all hope and the next day *The Times* stated, "The announcement that the Admiralty have at length relinquished all hope of hearing any further news of the missing sloop *Condor* will be received with universal sorrow. The *Condor*, it will be remembered, left Esquimalt on December, 2, 1901, for Honolulu where she was due on the 15th of the month. From the date of her departure from Vancouver Island nothing has been heard of her and very little wreckage has been discovered. The most probable hypothesis appears to be that she came into collision with another vessel soon after leaving port and that both ships foundered".

In point of fact an American collier, the *Manhattan*, then in the vicinity, was reported missing at the same time as the *Condor*. The loss of the sloop remains a mystery of the sea, for no survivors were ever found.

OUR PART of the surveying mission came to an end after three years and we left the ship to a relief crew to carry on where we left off. The ship's company came back home by the same route across Canada as we had used when we first went out and by a strange coincidence we crossed the Atlantic in the same liner, the *Tunisian*. At Devonport we were lodged in the depot ship *Duke of Wellington*, for there were no naval barracks at that time.

Discipline in the depot ship was very slack. This was not surprising seeing that hundreds of men passed through her every week and only remained a few days on board. One able

seaman came aboard so drunk that he climbed down the bowsprit and painted the nose of the Iron Duke on the figurehead with red lead. He was arrested and brought before the captain the following morning. His punishment was to climb down to the figure head and remove the red lead. He refused. I am not surprised. The bowsprit projected well over the jetty and there was a deep drop to the stone pier below. Without the aid of a boatswain's chair, he would have risked his neck. He got 90 days instead.

At the appointed day we received our back pay and a railway warrant and were given six weeks' leave, a fortnight for each year of service on a foreign station. While at Esquimalt most of us had contributed to a fund to have a beano when we finally returned to London. The rendezvous was the Angel at Islington where three horse-drawn coaches were waiting. Quite a number of the crew turned up with their lady friends and went on a tour of the town. Some got into trouble in the course of the evening but the following day, when the magistrates heard who they were, they were more amused than anything and the fines were purely nominal.

THE *EGERIA* continued in service until 1911. I have been able to trace her subsequent history thanks to the courtesy and assistance of the Royal Canadian Navy.

She is said to have been the last three-masted fully rigged auxiliary ship in the Royal Navy, in which she was officially classed as a sloop. She spent several more years surveying the coast of British Columbia, includ-

ing Vancouver harbour, and, when the Canadian government took over Esquimalt naval base from the Admiralty in 1905, she was left behind as obsolete. In 1911 came strong pressure to have the Admiralty hand her over as a gift to the Boys' Naval Brigade at Vancouver. This was not done and she was put up to auction. After all the useful stores and fittings had been taken away, she was towed to Vancouver on December 17, 1911, to be sold.

The late Captain Eddie, examiner of masters and mates, had the idea of turning her into a training ship for the Navy League. A patriotic junk merchant was forthcoming with the funds to provide the money to cover the mortgage. She was taken over by a number of Vancouver yachtsmen under the command of Captain Eddie and moved to Deadman's Island. Some 20 local lads signed on for training and were quartered in the ship. Afterwards she was recovered from the junk merchant for \$6,000 for the Boys' Naval Brigade. She was completely refitted and made seaworthy so that she was able to make occasional cruises. When war broke out in 1914, there was no money available to keep her in repair and she was finally disposed of for scrap. She was beached on the north shore of Burrard Inlet, drenched with oil, explosives were placed on board and she was set on fire. Unfortunately three men were killed in the subsequent explosion. What remained of the metal of the old *Egeria* was picked up for salvage.

Eheu fugaces! All good things must come to an end. Looking back over a very long life, I can say that aboard the *Egeria* I spent the three happiest years of my service with the Royal Navy.

This is the last of five instalments selected from the autobiography of Mr. Arthur Walpole

A Note on 'The Laws of the Navy', Pages 14 and 15

"The Laws of the Navy", with accompanying drawings as reproduced on the centre pages of this issue, appeared once previously in *The Crow'snest*—in the November 1949 issue. Poem and drawings were copied from an illustrated booklet, entitled *Cornwallis*, published in the closing months of the Second World War. The cartoons are believed to have been drawn by Lt. (SB) Noel Langley, a talented RCNVR officer then stationed at HMCS *Cornwallis*.

The poem has an even earlier origin. It was written by Rear-Admiral Ronald A. Hopwood, CB, of the Royal Navy, and appeared for the first time in the *Army and Navy Gazette*, of July 23, 1896, and, to carry the story back a step further, the verse was

written in imitation of Rudyard Kipling's "Laws of the Jungle".

Another of Admiral Hopwood's poems that has become a part of naval tradition is "Our Fathers", first published on October 15, 1913.

"It is the jolly, breezy, ringing quality of his lyrics which has made Rear-Admiral Ronald A. Hopwood the chosen Laureate of the Fleet," said a London *Daily Telegraph* reviewer. "You will find his books of verse in the officers' cabins wherever His Majesty's ships are plying; you will find them in the bunks down below; and many copies are sent home to the girls they left behind them, as the right good seaman's ideal of a right good seaman's song."

THE LAWS OF THE NAVY

Now these are the Laws of the Navy, unwritten and varied they be,
 And he that is wise will observe them, going down in his ship to the sea;
 As naught may outrun the destroyer, even so with the Law and its grip
 For the strength of the ship is the Service, and the strength of the Service, the ship.



1
 Take heed what ye say of your rulers, be your words softly spoken or plain,
 Lest a bird of the air tell the matter, and so, ye shall hear it again.

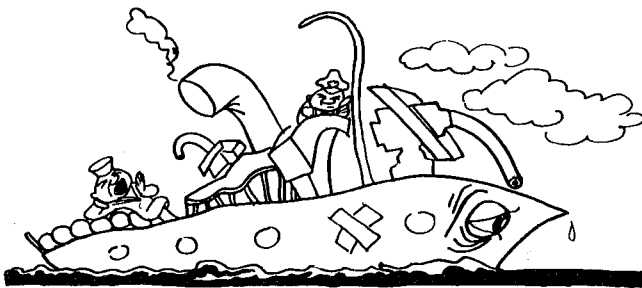

4
 When the ship that is tired returneth with the signs of the sea showing plain,
 Men place her in dock for a season, and her speed she reneweth again;



5
 So shalt thou, lest perchance thou grow weary, in the uttermost parts of the sea,
 Pray for leave, for the good of the Service, as much and as oft as may be.

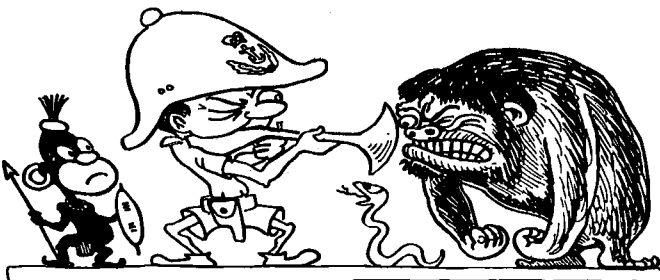

8
 If ye win through an African jungle, unmentioned at home in the press,
 Heed it not; no man seeth the piston, but it driveth the ship none the less.



9
 Do they growl? It is well, be thou silent so that work goeth forward again;
 Lo! the gun throws her shot to a hairsbreadth, and shouteth, yet none shall complain.
 Do they growl? And the work be retarded? It is ill, speak whatever their rank
 The half loaded gun also shouteth, but can she pierce armour with blank?



12
 Dost think in a moment of anger 'tis well with thy seniors to fight?
 They prosper, who burn in the morning, the letter they write overnight;
 For some there be shelved and forgotten with nothing to thank for their fate
 But that, on a half sheet of foolscap, a Fool "had the honour to state."

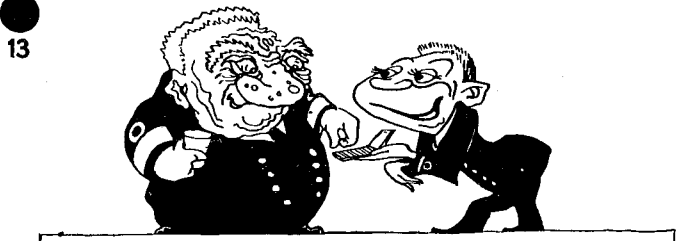

13
 If the fairway be crowded with shipping, beating homeward the harbour to win
 It is meet that, lest they should suffer, the steamers pass cautiously in;
 So, when thou nearest promotion, and the peak that is gilded is nigh,
 Give heed to thy words and thine actions, lest others be wearied thereby;
 It is ill for the winners to worry, take thy fate as it comes with a smile,
 And when thou art safe in harbour, they will envy but may not revile.

- - - by Rear-Admiral R. A. Hopwood

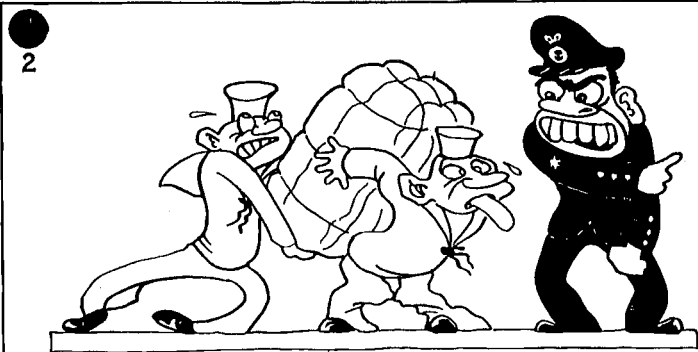

If ye labour from morn until even' and meet with reproof for your toil,
It is well; that the gun may be humbled, the compressor must check the recoil.

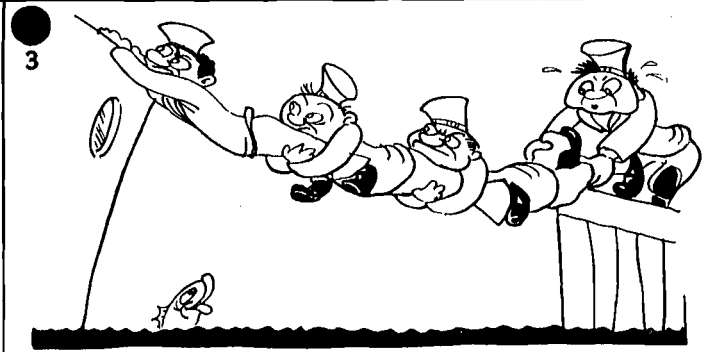

On the strength of one link in the cable dependeth the might of the chain;
Who knoweth when thou may'st be tested? So live that thou bearest the strain.



Count not on certain promotion, but rather to gain it aspire,
Though the sight-line shall end on the target, there cometh perchance a misfire.

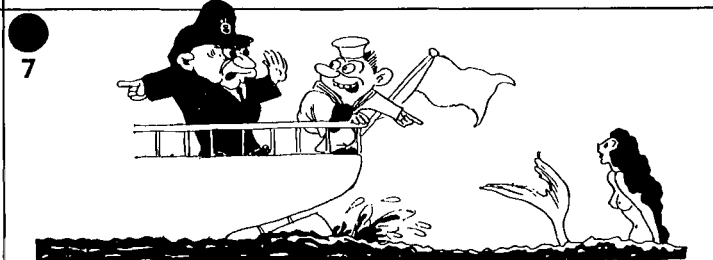

Canst follow the track of the dolphin, or tell where the sea-swallows roam?
Where Leviathan taketh his pastime, what ocean he calleth his home?
Even so, with the words of thy rulers, and the order whose words shall convey
Every Law is as naught beside this one, "Thou shalt NOT criticise, but OBEY."
Saieth the wise, "How may I know their purpose?" then acts without wherefore or why;
Stays the fool but one moment to question, and the chance of his life passeth by.



Doth the paintwork make war with the funnels? Do the decks to the cannon complain?
Nay. They know that some soap or a scraper unites them as brothers again;
So ye, being Heads of Departments, do your growl with a smile on your lip
Lest ye strive and in anger be parted, and lessen the might of your ship.

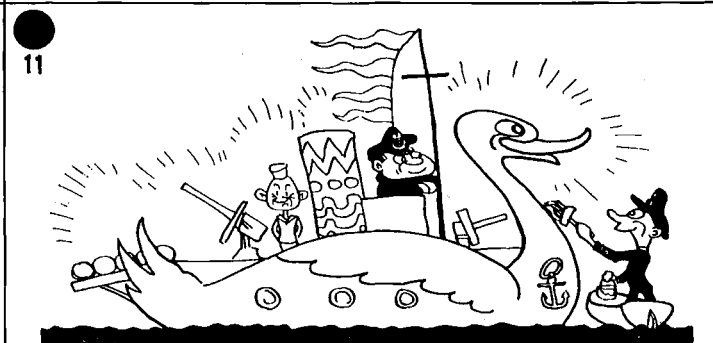

Dost deem that thy vessel needs gilding, and the Dockyard forbear to supply?
Place thy hand in they pocket and gild her; there be those that have risen thereby.

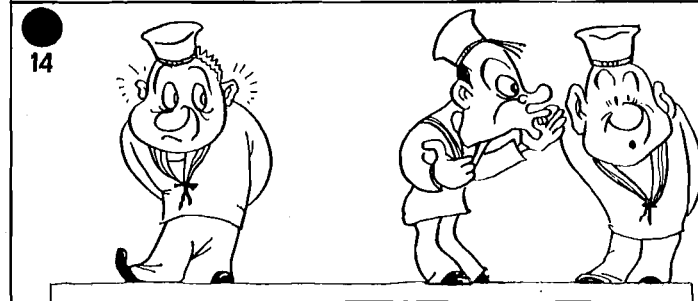

Uncharted the rocks that surround thee, take heed that the channels thou learn,
Lest thy name serve to buoy for another that shoal, the Courts-Martial Return;
Though an Armour plate belt may protect her, the ship bears the scar on her side,
It is well if the Court shall acquit thee; it were best hadst thou never been tried.

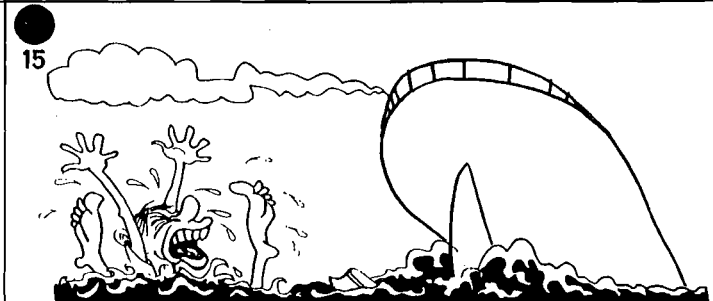

Now these are the Laws of the Navy, unwritten and varied they be
And he that is wise will observe them, going down in his ship to the sea;
As the wave rises clear of the hawsepipe, wanders aft and is lost in the wake,
So shall ye drop astern, all unheeded, such time as the Law ye forsake.

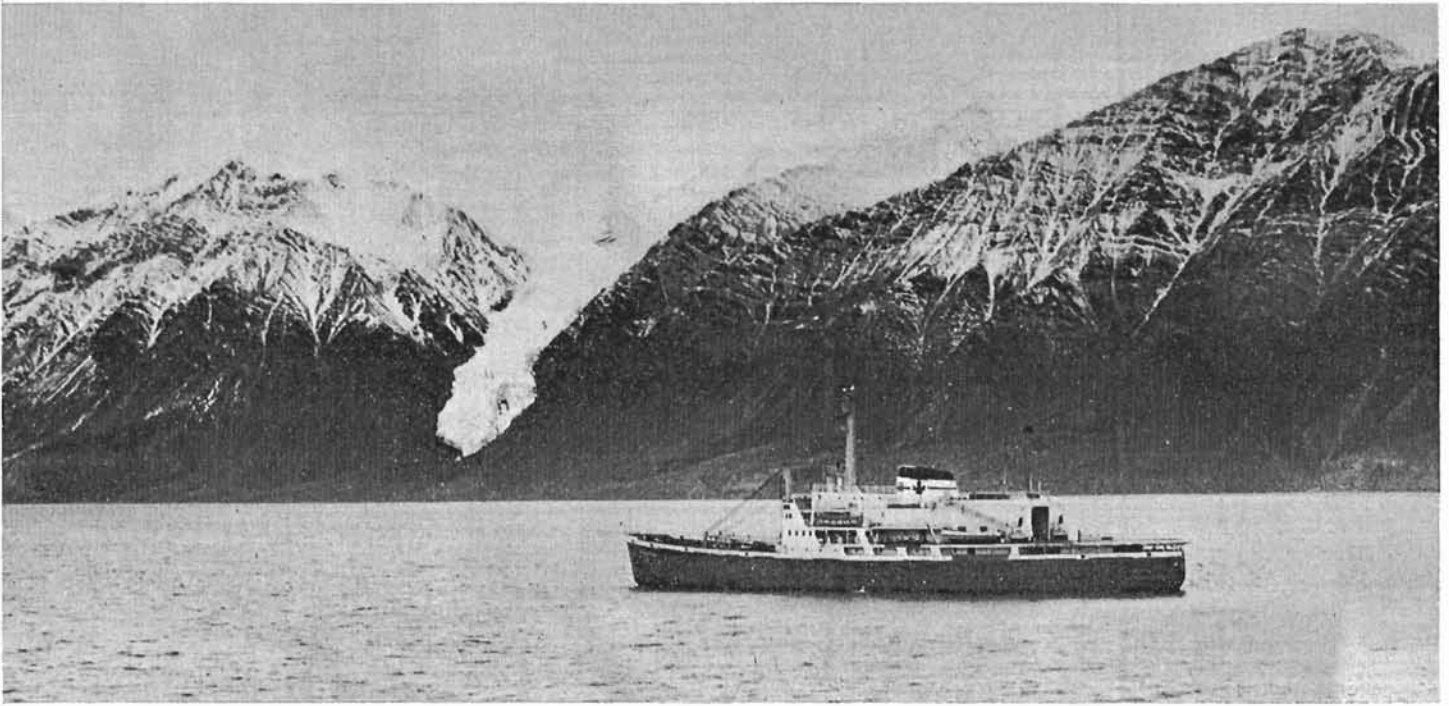

The Canadian Coast Guard's largest icebreaker, John A. Macdonald, in Tanquary Fiord, farthest north waterway of the Canadian archipelago, during the 1962 Arctic resupply operations of the Department of Transport. It was the first time any Coast Guard vessel had ever penetrated so far north. The fiord was previously uncharted. The photo was taken at midnight on August 24, 1962. (Department of Transport Photo)

NORTH WITH THE COAST GUARD

IT WAS MY good fortune to serve during the summer of 1962 in the Canadian Coast Guard Ship *John A. Macdonald*, the largest icebreaker in Canada and the pride of the fleet, on the most northerly voyage ever made by a Canadian ship.

All of the Arctic ships have fire-truck red hulls and it was not difficult to locate my ship in Montreal where I joined on July 25. I was welcomed aboard by the master, Captain James Cuthbert, whose opening remark was, "What do you think of my rhubarb?" He was referring to the image of a maple leaf on the funnel. This was my first indication that I was on board one of those happy ships whose personality equals that of the captain.

The *John A. Macdonald* departed Montreal on July 26 to engage in Arctic survey and supply tasks in the Arctic. Other vessels operating under the control of the Coast Guard in the Arctic during 1962 included six icebreakers, seven special shallow draft northern service vessels and two smaller shallow draft cargo vessels, an Eastern Arctic passenger and cargo vessel, three chartered tankers and seven chartered day cargo ships.

The icebreakers served as escort for the other ships while the convoys visited more than 40 ports of call, including defence outposts, weather stations, missions, trading posts and Eskimo communities. Four of the big icebreakers, CCG Ships *Macdonald*, *Labrador*, *d'Iberville* and *N. B. McLean*, covered thousands of miles of Arctic sea lanes, while research programs were carried out by scientific teams from the Department of Mines and Technical surveys, National Defence Department and related agencies. Similar work was done in the Western Arctic by the Victoria-based Coast Guard icebreaker *Camsell*:

Oceanographic and hydrographic studies, ice research and geomagnetic studies were major parts of the scientific undertakings. To the satisfaction of both the Coast Guard Ship's captains and the research parties, the channels of the Archipelago were ice-free to a greater degree than at any time since the Department of Transport's fleet began its annual supply operations to the High Arctic in 1954.

By
Lt.-Cdr. J. P. Croal

As a result of the ice-free channels, several new "firsts" were established by the CCGS *John A. Macdonald*. The run north through the usual fog and icebergs of Davis Strait and Baffin Bay was marked by an Arctic Circle Crossing Ceremony of most hilarious proportions, in which some 28 poor souls were indoctrinated by Rex Arcticus, his buxom wife and Court who arrived on board by way of the forepeak hatch.

After an inspection stop at the nuclear-powered automatic weather station at Sherwood Head, on the southern tip of Axel Heiberg Island, the ship took part in the supply run to the joint Canadian-U.S. weather station at Eureka, Ellesmere Island, along with CCGS *d'Iberville*, commanded by Captain Wilfred Dufour. It was the first time two vessels had even been to the weather station simultaneously. The *Macdonald* then proceeded north and east into the uncharted waters of Greeley Fiord and Tanquary Fiord on northern Ellesmere Island to land building material and equipment which was used this spring to establish a research station.

As we entered Tanquary Fiord in the late evening of August 22, the Chief

Officer, Mr. Mel Lever, and I were flown to the head of the fiord by helicopter to select the station site and a suitable landing beach. Shortly thereafter the ship anchored and the cargo was ferried ashore in the landing barges.

This operation continued for several hours after midnight, during which a strong wind whistled up the fiord, causing a choppy surf on the landing beach. Temperature conditions were just above freezing, with the midnight sun hidden by the high mountains surrounding us, and we felt as if we were in another world. Never before had this area seen such activity.

The *Macdonald's* seamen, mostly Nova Scotians and Newfoundlanders, were magnificent, often wading into the freezing surf to recover drums of fuel, and I was uncommonly proud to be a part of this Canadian heritage of glittering ice and the rugged beauty of the Arctic.

On completion of this operation our cache of cargo was marked by a large wooden cairn containing a metal cylinder with a list of the ship's crew and passengers. The cylinder bears a likeness of Her Majesty Queen Elizabeth II on one end, and the maple leaf on the other. I am sure that if anyone objects to such a use of these Canadian one-cent pieces, Captain Cuthbert, Mr. Pick, the Scottish second engineer, and I, the originators of the idea, will be happy to pay the cost of minting two new ones. This establishes the farthest north for any Canadian ship in Arctic waters.



Beacon erected by the crew of CCGS John A. Macdonald at the northernmost section of Tanquary Fiord. (Department of Transport Photo)

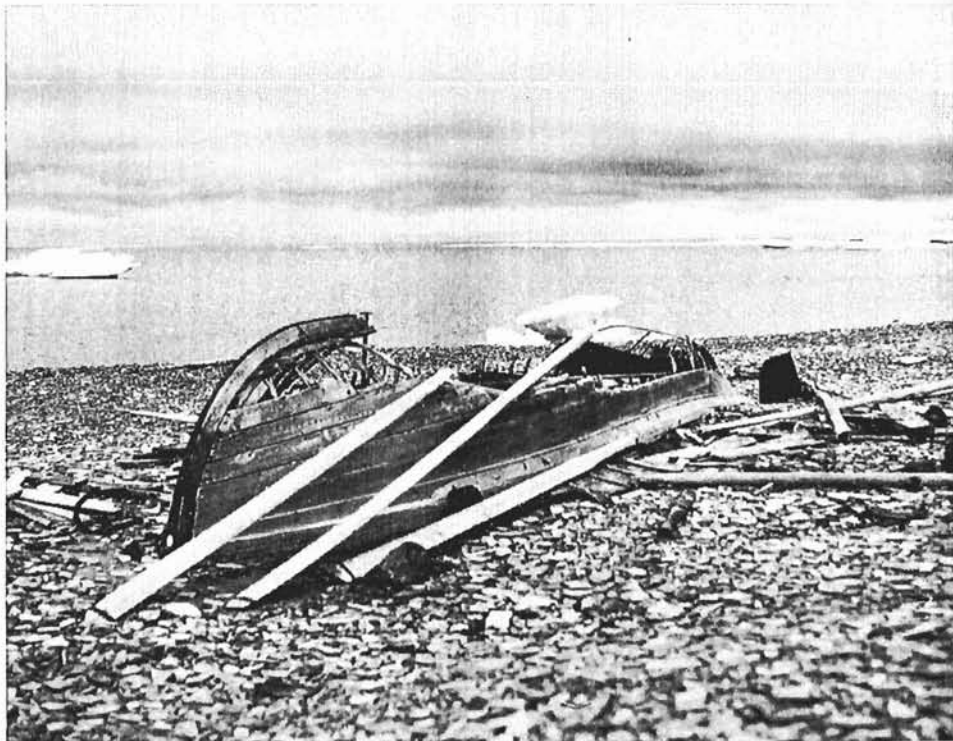

A wrecked ship's boat from the Penny expedition of 1850-51 found on the northeast corner of Cornwallis Island during the visit of CCGS John A. Macdonald. (Department of Transport Photo)

The *Macdonald* then returned to Eureka Sound and probed her way northwest into Nansen Sound, until stopped by the extremely heavy ice of the permanent polar pack.

She subsequently turned south and thence westward, making the first transit of the uncharted waters of Norwegian Bay, north and west of Graham Island, and of Belcher Channel. She turned south through Penny Strait, which she had penetrated from the south in 1960, and returned to Resolute Bay, where she had called earlier. She thus became the first ship to circumnavigate Devon Island.

Departing Resolute Bay, the icebreaker went westward in Viscount Melville Sound and M'Clure Strait, where oceanographic and hydrographic surveys were carried out, going northwest almost to Prince Patrick Island before returning.

She later made history by circumventing Prince of Wales Island, entering Peel Sound and returning to Viscount Melville Sound by way of M'Clintock Channel. This channel has long been regarded as treacherous due to extreme ice conditions.

Later the *Macdonald* proceeded south through Peel Sound, passed eastward through Bellot Strait into the Gulf of Boothia. There she escorted the Canadian Hydrographic Ship *Baffin* into Foxe Basin by way of Fury and Hecla

Strait. En route the *Macdonald* sustained ice damage to two of her three propellers, but was able to continue with the remainder of her duties, having during the course of the summer gone completely around Baffin Island.

CCGS *d'Iberville* was mainly engaged during 1962 in geomagnetic studies in Lancaster Sound and Barrow Strait area, related to fixing the present position of the North Magnetic Pole. She later took up her usual duties in Hudson Strait, providing icebreaker escort, when required, for grain ships operating between Churchill, Manitoba, and European ports. She remained on this duty until the close of the shipping season at the end of October.

CCGS *Labrador*, commanded by Captain Norman Clark, carried out the annual supply to Alexandra Fiord on the east side of Ellesmere Island, on completion of which she carried out extensive oceanographic and hydrographic surveys.

Early in October the *Labrador* made a special run to pick up scientists of the Arctic Institute of North America at a research station on the north side of Devon Island when deteriorating weather conditions made it evident the men would not be taken out by air as planned.

The *N. B. McLeun*, commanded by Captain Marius Gagnon, made two trips north in 1962. She first visited the Hud-



Chief Officer M. Lever, of CCGS John A. Macdonald, and Lt.-Cdr. James Croal, author of the accompanying article, put a J-5 tractor ashore at Tanquary Fiord. (Department of Transport Photo)

son Strait area for the commissioning of lights and other aids to navigation, then proceeded to Resolute Bay to embark a geomagnetic team. For some time this team worked aboard the *McLean*; later they transferred to CCGS *d'Iberville*. The *McLean* then returned south, took on a new cargo and returned to Lancaster Sound region to deliver supplies at several points.

In the Western Arctic, CCGS *Camsell*, commanded by Captain Arthur Davidson, escorted cargo vessels along the shallow coastal channels as far east as Spence Bay and Gjoa Haven. At one point she suffered some damage when

she struck rocks in an area where charts were of limited accuracy. She too carried a hydrographic party that added much to existing knowledge of these waters.

CCGS *C. D. Howe*, under the command of Captain J. A. Ouellet, carried out her usual Eastern Arctic run, with members of the Eastern Arctic Patrol aboard to administer matters pertaining to the health and welfare of the Eskimo population and to law and order in the North. On her return she brought back Eskimos requiring medical treatment at the special National Health and Welfare Department centres established for that purpose.

During the 1962 shipping season the Canadian Coast Guard ships and vessels of the supply convoys handled a total of 100,000 tons of cargo.

On completion of the summer Arctic operations the icebreakers undergo a refit to prepare them for their winter icebreaking duties in the Gulf of St. Lawrence and St. Lawrence River ports, and ports on the Eastern seaboard. However, this is another story.

As can be noted, the ships of the Arctic fleet spend long periods at sea each year, carrying out many tasks of importance to the economy and defence of Canada. Quite often these tasks are highly nerve-wracking to the officers and crew when operating in uncharted waters.

To break the monotony, ship's concerts are organized, bingo, card games and dart tournaments are popular, as well as jam sessions by those who are gifted with the ability to play musical instruments.

The humour of French Canada, Nova Scotia and Newfoundland is always evident in the friendly rivalry which exists between the icebreakers. One night on the *Macdonald's* bridge the officer of the watch, a French-Canadian, was having difficulty understanding a long garbled transmission on the RT. Throwing up his hands and obviously mimicking Captain Cuthbert's broad tongue, he said, "My God! Yon man canna speak French and he canna speak English".

The crews of the icebreaker fleet live up to an old Arctic saying: "You don't have to be crazy to work here but it helps". In 17 years of Arctic operations, I have come to realize there is a lot of truth in this saying, if one interprets it to mean the ability to maintain a sense of humour and to get along with one's shipmates under conditions of isolation and sometimes hardship.



Home from the Sea



McIlhagga New Head of NOAC

Election of L. B. McIlhagga, of Winnipeg, as national president of the Naval Officers' Associations of Canada occurred at the closing business session of the 18th annual general meeting of the NOAC in London, Ontario, in June.

During the course of the convention resolutions were considered which had more than purely naval interest, although many were specifically associated with the naval service. Bearing on the question of Canada's national flag was the resolution recommending that the Canadian navy's White Ensign be altered by adding the Canadian coat of arms similar to that worn by the nation's Red Ensign. The convention recognized the pride and tradition involved in the White Ensign, but felt that a distinctive flag was desirable to identify the Canadian naval service.

In considering the question of nuclear weapons, the convention took note of current commitments to NATO apparently involving the use of nuclear weapons by the Canadian Army and the Royal Canadian Air Force. The NOAC went on record as supporting the acquisition of the nuclear arms by the RCN if such a move were deemed necessary or desirable by the naval service in the light of NATO commitments or other requirements.

The convention noted the current plans for a new national War Memorial in Ottawa, and expressed its opposition to the expenditure of public funds on the type of memorial proposed. It was resolved that the association should communicate with other veterans' associations with a view to obtaining agreement on a more practical and living memorial than that now planned.

Serving with Mr. McIlhagga on the national executive will be: Rear-

Admiral Walter Hose, Windsor, honorary president; Vice-Admiral H. G. DeWolf, Ottawa, honorary vice-president; A. P. Gregory, Saint John, N.B., past president; C. H. Wills, Vancouver, honorary counsel; H. R. McDonald, Halifax, vice-president (Maritimes); J. J. Trainor, Ottawa, vice-president (Quebec); C. Van Laughton, Exeter, vice-president (Ontario); H. B. Vannan, Winnipeg, vice-president (Prairies); Roy Rich, Vancouver, vice-president (West Coast); and E. D. Burns, Montreal, secretary-treasurer.

LETTER OF EXPLANATION

Dear Sir:

Referring to the August 1963 issue of *The Crownsnest*, page 19, under the heading of "CNA General Meeting Held," I wish to record a correction to paragraph 5 of this news item. The RCNBF Incorporated has a voting membership of 75 naval and former naval personnel. The Canadian Naval Association requested representation in the fund and was advised that membership was restricted to individuals having an interest in the work which the fund was doing. The Canadian Naval Association was invited to submit a list of names of individuals who would be willing to serve as voting members from which, list an election would be made. In April, 1963, the General Secretary of RCNBF advised the executive secretary-treasurer of the Canadian Naval Association that there were no vacancies in our voting membership at that time.

As a matter of interest I am pleased to note that on May 27, 1963, Mr. Herbert A. Maynard was elected to be a voting member, and he has accepted his election.

Yours very truly,
H. McCLYMONT
General Secretary

PO Box 505,
Ottawa 4, Ont.



This is the 45-foot model of HMCS Huron that cruised northwestern Ontario on behalf of the Sault Naval Veterans' Association. It was one of the highlights and prize winners of the Rotary Club's annual Community Night parade in Sault Ste. Marie, and also was a winner in parades in Thessalon and Bruce Mines. Pacing the ship is Guy Gravelle, president of the Sault Naval Veterans. (Photo courtesy Soo Star)

PROMOTION

- How come old so-and-so was selected for promotion?
 Why were only three men of our rank and trade selected this time?
 Where do I stand for promotion?
 It is possible the "machines" have made a mistake?

THESE ARE some of the questions more often asked when the names of men who have been promoted are promulgated. The answers are available from various sources, but not everyone wants to be bothered "looking it up", or seeking an explanation from higher authority.

So perhaps a summary of the promotion system, how it works, and why it works the way it does, may not be out of place.

Who gets promoted?

You, too, can understand the promotion system. It is described in Chapter 2 of MAP (*Manual of Advancement and Promotion*). You are assessed at least twice a year by your immediate supervisor on a CNS 4000 form. These forms are sent to Naval Headquarters where the scores marked by your assessor are converted into points. These points are averaged out with points received from your previous assessments and the result is your "Average Performance Evaluation". This is the measurement of your performance in your present rank and although it's not perfect (no system which relies on human nature and human judgment can be perfect), it is the best device the Navy has for this purpose.

If you are in promotion zone, i.e. fully qualified, to your points for Average Performance Evaluation are added points for education, time in promotion zone and time in service. The total of these is called your "Composite Score". The names of all men in the port division in your rank and trade are listed

together in order of composite score. If you have the highest composite score, you'll be at the top of the "Status List", if you have the lowest score your name will be at the bottom. If there are four vacancies in the next higher rank, then the top four men on the list are normally selected for promotion.

The term "normally" is used in the last sentence because there is one circumstance under which a man would be skipped and the man next lower on the list selected instead. This occurs if a man has a high composite score—perhaps he has high education points and lots of seniority, giving him maximum points for time-in-zone service—but he has an average performance evaluation which isn't considered high enough to justify his promotion. In other words, he has a high score but he isn't performing very well in his present rank. He is skipped in the promotion selection until his performance improves.

So, the promotion system determines who is selected for promotion. As you know, the big factor is performance evaluation—your assessment. You can,

however, improve your position on the status list through educational credits, and sometimes those few extra points might make the difference.

Figure 1 shows part of a typical status list. JONES was not selected—his performance evaluation is lower than the minimum required for promotion to P1.

How many promotions?

At the beginning of each year Naval Headquarters makes a "Promotion Plan". This plan is a forecast of the number of men who will be promoted, during the year, in each rank of each trade. Basically the number to be promoted in a specific trade is determined by the number borne at the start of the year, expected wastage, the rank complement for that trade, and by the numbers of men who will be in the promotion zone. When all the planned promotions are taken into account, the probable borne strength during the year must not exceed the rank ceilings approved by the Rank Structure Committee and provided for in the year's financial estimates.

In selecting men for promotion in a promotion competition an attempt is made to select in each of the two competitions approximately half of the number planned for the year. This is not always possible. When two men are tied in composite score both may be promoted, at the same time, rather than one now and one six months later.

In trades which are up to rank complement, "trickle" promotions are made. This prevents complete stagnation and

Position	O.N.	Name	Rank/Trade	Points Ave. P.E.	Points Time in Service	Points Education	Points Time in Zone	Composite* Score	Selected for Promotion (8 req'd)
1	E63674	Arthurs J.	P2BN4	130.3	25.0	5.0	40.0	200	X
2	E71208	Brown Q.	P2BN3	126.8	25.1	5.0	40.0	197	X
3	E96512	Cross R.	P2BN4	123.6	26.9	5.0	40.0	196	X
4	E80000	Dow M.	P2BN3	136.2	15.3	5.0	37.7	194	X
5	E80312	Ervin J.	P2BN3	122.2	25.0	5.0	40.0	192	X
6	E69107	Fox M.	P2BN3	122.3	23.8	5.0	40.0	191	X
7	E36543	Howe S.	P2BN3	130.9	12.0	5.0	38.9	187	X
8	E00910	Jones B.	P2BN4	103.4**	26.9	12.5	40.0	183	—
9	E72222	Inch P.	P2BN3	120.3	16.1	5.0	38.9	180	X
10	E91564	Knoo T.	P2BN3	126.8	14.0	0.0	37.7	179	—

* This determines the order of names.
 ** This low performance evaluation could prevent promotion.

Figure 1

permits the best men in those trades to get ahead. A minimum of five per cent of the number in the promotion zone has been promoted annually in such trades. If it is not possible to promote the desired numbers in a higher rank in a specific trade, additional men are promoted in the next lower rank, if sufficient candidates are available.

Where do I stand?

This is the hard one. This is the one thing the Navy won't tell you. There are reasons for this. The promotion system, as it is now working is efficient. It is designed to promote the best men and, in general, it does this.

The old policy of telling a man exactly where he stood in the list often resulted in pressures on the assessor, tending to prevent truly objective assessments being made. This in turn produced errors in the system itself, reducing its efficiency in discrimination and accuracy in general.

The "Quarter of Average Performance Evaluation" printed on your status cards does give you some indication, if properly interpreted. This is not an indication of composite score standing but it tells you how your average performance evaluation compares with those of other men against whom you are competing.

How can a man in a lower quarter be promoted ahead of a man in a higher quarter? Well, take a look at Figure 1—the "status list" again. If CROSS is in the second quarter, you can see why he would have been promoted ahead of DOW, if only three had been promoted, although DOW could well be in the first quarter. Naval Headquarters is studying this item in view of the con-

fusion reported, and some changes may well be made to the information given to you on your status cards.

You have seen that performance evaluation is the big factor; that education and time increase your composite score. Your promotion opportunity is also affected by the number of openings which occur. Now, having an idea of these, perhaps you can make a better guess. One thing is sure, if you improve your performance evaluations, and get maximum points for education you will better your chances. It's worth the try!

The Machines

Machines are used in Naval Headquarters in calculating performance evaluations, scores and averages, in recording qualifications received, and in printing lists and cards. However, every operation is checked and double-checked by staff members, who are familiar with their functions in the system. When errors do occur, they are the fault of the human factor in the system, not that of the "machine". If more of the calculations and operations were done by hand than is now the case, the greater would be the probability of error.

Recently your Promotion Monitors visited Naval Headquarters and watched a promotion "run". This included screening the machine operations and the checking operations. What they saw made them confident that the chance of machine error was small indeed.

Errors, when they occur, usually result in incorrectly not crediting a man with a qualification—an Alternate Sheet item is skipped perhaps. Don't hesitate to query what you feel is incorrect information on your qualification card or

status card; if you're right, the records will be corrected and, if you should have been promoted, you will be.

Elimination

A secondary use of the promotion system is its use in indicating those men whose performance is so poor that it's questionable whether they should be kept in the Navy. After all of the CNS 4000 forms have been scored, the past performance assessments of all men in the lowest five per cent of the current assessments are scrutinized. Men whose performance has been very low over several assessments are placed on an "elimination list". No man, however, is placed on the list because of one poor assessment.

The elimination list is sent to RCN Depot where a board is held on men of senior rank, or a Commanding Officer's recommendation is obtained on men of junior rank. Recommendations are forwarded to the Senior Officer-in-Chief Command who then authorizes release, reversion or retention as the case may be.

What can you do?

If you and your messmates don't understand the promotion system see your Divisional Officer. If he can't explain or answer the query he will get the information from the Promotion Monitor. The better we all understand the system, the better it will work.

As a last word on promotion, remember that promotion must be earned. It won't happen to the man who sits around waiting for it. The only way to compete for promotion is to get out and work for it.

- AND YOUR CHANCES

THE JUNE issue of *The Crow'snest* carried a table showing the trade advancement ceiling. This time there is an opportunity to look into the crystal ball and predict one's chances for promotion.

Here is a summary of the intended promotions for the fiscal year 1963-64 by port division—Halifax, Esquimalt or Gloucester—with a comparison to the total number made during 1962.

To Rank				Promoted	
	HPD	EPD	GPD	Total	1962
C1	33	14	2	49	69
C2	83	36	10	129	129
P1	201	55	13	269	248
P2	299	72	27	398	384
LS	238	165	46	749	780



PROMOTION PLAN - 1963 - 64

TRADE		TO G1		TO G2		TO P1		TO P2		TO LS	
		HPD	EPD	HPD	EPD	HPD	EPD	HPD	EPD	HPD	EPD
Boatswain	(BN)	1 (26)	3 (12)	2 (51)	1 (35)	3 (60)	2(31)	3(62)	4(67)	20(72)	3(32)
Weaponman Surface	(WS)	1 (17)	0 (9)	5 (30)	3 (25)	5 (41)	1(10)	20(38)	5(9)	20(155)	24(41)
Firecontrolman	(FC)	2 (12)	0 (6)	1 (17)	1 (13)	2 (17)	1(20)	12(21)	1(11)	25(66)	2(25)
Weaponman Underwater	(WU)	1 (2)	0 (4)	4 (8)	4 (7)	16 (21)	8(13)	29 (53)	5(8)	30(64)	13(22)
Songman	(SN)	1 (7)	1 (6)	2 (4)	3 (10)	16 (27)	6(10)	9(18)	7(11)	40(112)	24(40)
Radar Plotter	(RP)	2 (4)	2 (5)	8 (19)	4 (8)	3 (21)	2(8)	9(16)	4(6)	40(107)	21(36)
Signelman	(SG)	1 (10)	2 (4)	8 (16)	6 (10)	8 (30)	4(7)	11(27)	6(14)	30(94)	14(24)
Radioman	(RM)	1 (13)	0 (5)	1 (16)	2 (6)	10 (41)	10(25)	18(32)	6(28)	44(146)	22(37)
Radioman Special	(RS)	2 (6) - GFD		10 (21) - GFD		13 (18) - GFD		27(48) - GFD		46(120) - GFD	
Engineering Technician	(ER)	6 (25)	2 (31)	23(175)	6 (124)	83 (135)	3(62)	59(101)	5(86)	117(502)	6(126)
Electrical Technician	(ET)	1 (31)	1 (18)	6 (29)	1 (20)	4 (28)	1(18)	24(41)	11(26)	23(151)	8(30)
Electronic Technician	(LT)	1 (18)	0 (13)	1 (17)	1 (20)	12 (26)	5(16)	17(35)	1(19)	2(2)	0(2)
Hull Technician	(HT)	1 (34)	1 (15)	2 (42)	1 (24)	0 (6)	2(6)	9(15)	6(12)	16(38)	9(15)
Weaponman Air	(WA)	0 (4)	-	0 (5)	-	1 (13)	-	1(8)	-	1(24)	-
Naval Aircrewman	(NA)	2 (2)	-	1 (2)	-	4 (6)	-	14(36)	-	16(36)	-
Naval Airman	(AM)	0 (6)	-	1(12)	-	1 (23)	-	3(43)	-	2(51)	-
Aviation Technician	(AT)	1 (18)	-	3 (60)	-	3 (56)	-	5(95)	-	6(138)	-
Air Electrical Technician	(EA)	0 (9)	-	2 (39)	-	2 (32)	-	3(30)	-	11(22)	-
Air Electronic Technician	(RA)	1 (12)	-	1 (32)	-	5 (42)	-	9(43)	-	15(35)	-
Ship's Writer	(WR)	1 (15)	0 (8)	1 (11)	0 (10)	-	-	-	-	-	-
Administrative Writer	(AW)	-	-	-	-	1 (17)	0(8)	1(24)	0(4)	4(23)	1(18)
Pay Writer	(PW)	-	-	-	-	1 (26)	0(9)	1(27)	0(7)	2(27)	1(11)
Ship's Storesman	(ST)	1 (20)	1 (10)	1 (20)	1 (19)	-	-	-	-	-	-
Victualling Storesman	(VS)	-	-	-	-	2 (35)	1(20)	2(38)	1(12)	2(33)	1(19)
Naval Storesman	(NS)	-	-	-	-	1 (30)	1(17)	2(37)	1(20)	3(64)	1(19)
Commissaryman	(OM)	3 (22)	1 (7)	2 (40)	1 (27)	-	-	-	-	-	-
Cook	(CK)	-	-	-	-	3 (43)	1(18)	4(86)	1(38)	12(108)	2(55)
Steward	(SW)	-	-	-	-	1 (27)	3(11)	7(35)	1(23)	20(66)	4(30)
All Medical Trades		4 (10)	0 (3)	6 (24)	0 (9)	7 (25)	1(24)	7 (12)	1(18)	14(29)	1(15)
Clearance Diver	(CD)	1 (1)	0 (0)	1 (2)	1 (2)	2 (2)	1(3)	5(10)	2(3)	4(7)	6(12)
Physical & Rec. Trainer	(PR)	0 (3)	0 (2)	0 (4)	0 (2)	2 (11)	0(7)	0(3)	1(2)	2(5)	1(4)
Meteorologist's Mate	(MO)	0 (0)	-	1 (3)	-	0 (1)	-	1(3)	-	3(6)	-
Bandsman	(BD)	0 (3)	0 (1)	0 (7)	0 (6)	2(38)	1(24)	10(14)	2(2)	6 -	1(1)
Photographer	(PH)	0 (2)	0 (1)	0 (5)	0 (1)	0(7)	1(2)	0(5)	1(2)	1(5)	0
WRENS		-	-	0	-	1	-	4	-	7	-

A more comprehensive look at the number of men to be promoted during the current year is given in the accompanying table. The figures in brackets indicate the maximum number who will be in the promotion zone and competing for the vacancies. It must be remembered that the basic policy with regard to promotion is that those who deserve it most get it first. *It is not a reward for past services but rather an indication of faith that the individual being promoted will be able to continue performing efficiently in the higher rank.* It is obvious, therefore, that men who are not performing with a standard of

at least the average of their group cannot be counted upon to perform with an average standard in the higher rank. In short, all of the men included in the bracketed figures are qualified for promotion according to minimum

regulations. However all of them are not necessarily eligible. There may be some whose performance standards are not high enough.

For example, in the Halifax Port Division 21 P2WUs are in the promotion zone. As many as 16 may be promoted to P1WU during the year provided that they are performing at a standard which is considered to be above average.

By the time this article is published over half of the promotions will have been made. The balance, up to the limits shown, will be announced about the end of January.



THE NAVY PLAYS

Fraser Wins Two Titles

In spite of having half of the ship's company on leave during August, the *Fraser* still managed to win two Pacific Command championships. The soccer team came through with several close and hard fought wins, including a 2-1 triumph over the *Cape Breton* for the trophy.

The softball team had an easier time of it, winning most of their games by a wide margin. The closest game was a 9-5 victory over *Naden* for the championship.

Cadets Compete in Highland Games

A group of 22 UNTD cadets this past summer got a taste of Gaelic when they were invited to participate in the annual track and field meet sponsored by the Highland Association of Antigonish, N.S.

The cadets were well represented in most events in the two-day games program.

A four-man team consisting of Cadets Andre Dallaire, Terrence Waterhouse, Clifford Nelder and William Shambrook placed second in the 440-yard relay, while cadet Richard Christy placed sixth in the mile run and cadet Robert Nugent placed fifth in the men's open three-mile event.

In the pole vaulting Cadets Clifford Nelder and Clayton LaFleur placed first and third, while cadet John Donaldson placed third in the junior division broad jumping.

Cadet Ian Richmond, of London, Ont., placed third in the piping competition.

During their stay in Antigonish the cadets were billeted in private homes.

There have been naval competitors in the past but this was the first time a UNTD team had participated in the Highland Games meet.

New Golf Course Near Shearwater

A tri-service golf course is being constructed on National Defence property at Hartlen Point near *Shearwater*. To be known as the Hartlen Point Tri-



Piped through the streets by Cadet Ian Richmond, accompanied by drummer Cadet David Freeman, a division of UNTD cadets marches through the town of Antigonish, N.S., where they competed in a two-day Highland Games track and field meet. (Hindle photo)



Competing in the Highland Games in Antigonish this year for the first time was a track and field team of UNTD cadets from HMCS Cornwallis. Front row, left to right, are Edward Graham, Robert Nugent, Terrence Waterhouse, Andre Dellaire, Clifford Nelder, William Shambrook and Gerald Marois; back row: Cadet Barry Keeler, Thomas Lundy, Allan Osborne, Leandre Hurtubise, Laoss Leivat, Richard Christy, Clayton LaFleur and John Donaldson, and Sub-Lt. Paul Arsenaut, coach. (DB-18106)

Service Golf Club, it was founded by the *Shearwater* Golf Club, and is now being constructed on a tri-service basis. Six holes are under construction with a planned opening date of early 1964.

Three holes were opened in mid-August for play on temporary greens and under winter rules condition.

The executive committee under the president, Cdr. Joe Paul, of *Shearwater*,

includes representatives of the three services. The club constitution permits membership to Army, Navy, Air Force, RCMP, Civil Service and retired service personnel. Construction is being financed by donations and by ships and establishments and by individuals purchasing a redeemable membership share at a cost of \$50. Annual dues are expected to be approximately \$35 per year.

Present plans include opening six holes with a temporary club house early 1964, expansion to nine holes in 1964 if possible, and eventually to 18 holes with a permanent club house.

The course is being constructed in the gun battery area at Hartlen Point with a magnificent view of the sea and the Halifax-Darmouth area.

Sailor Amasses Eight Track Medals

A one-man track team is what Ord. Sea. Richard Olfert proved to be when he turned out for a New Entry Track and Field Meet at Cornwallis this past summer.

He romped home with eight first place medals and thereby set an all-time new entry record for *Cornwallis*. His athletic efforts won him first in the 100-yard dash, broad jump, javelin throw, high jump, discus throw, shot

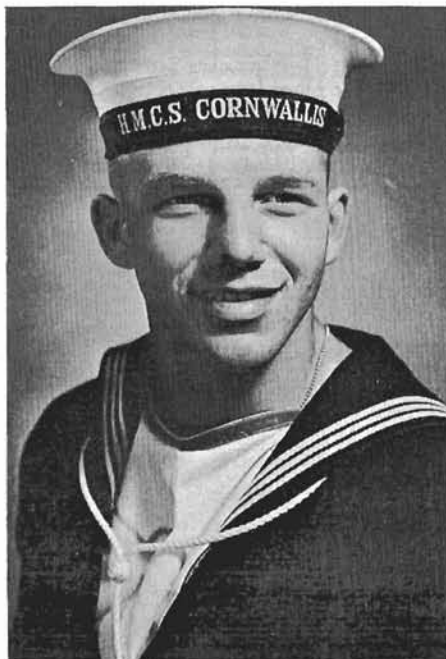

ORD. SEA RICHARD OLFERT

put and hop, step and jump. He was also a member of the winning mile-relay team.

His award-winning prowess was not confined to the playing fields. When passing out time rolled around for the *Saguenay* division, Ord. Sea. Olfert captured the "Best in Parade Training" award.

A former student at Sheridan Technical School in Sudbury, Ord. Sea. Olfert lists his special interests as track and field, and football.

Visitors Boast Skilled Bowlers

Halifax Bowling Centre's ten-pin lanes went international in early June when a pair of teams from the visiting United States task force triumphed over two Halifax squads. In another "grudge match", VS-39—the air arm of USS *Essex*—swamped a team from the *Essex* by 210 pins.

In an all-navy match, the RCN captured two strings from VS-39 but lost the pinfall decision as the Americans got a steady leadoff display of 539 by Bryron—an ABC-ranked trundler who would have picked up an ABC merit badge for a "triple" had he nailed one more pin in his third string. He fired a pair of 10s and then a 179 to just miss the award. High single for the winners went to Batdorf for a 210 that was matched by RCN's 210 in the 2454-2380 match.

The other outing saw USS *Essex* tumble the HBC house team, 2391-2322 with points again split.

In the all-American match—third in a series that has ranged from port to port—VS-39 took their third straight triumph at the *Essex's* expense, 2582-2361.

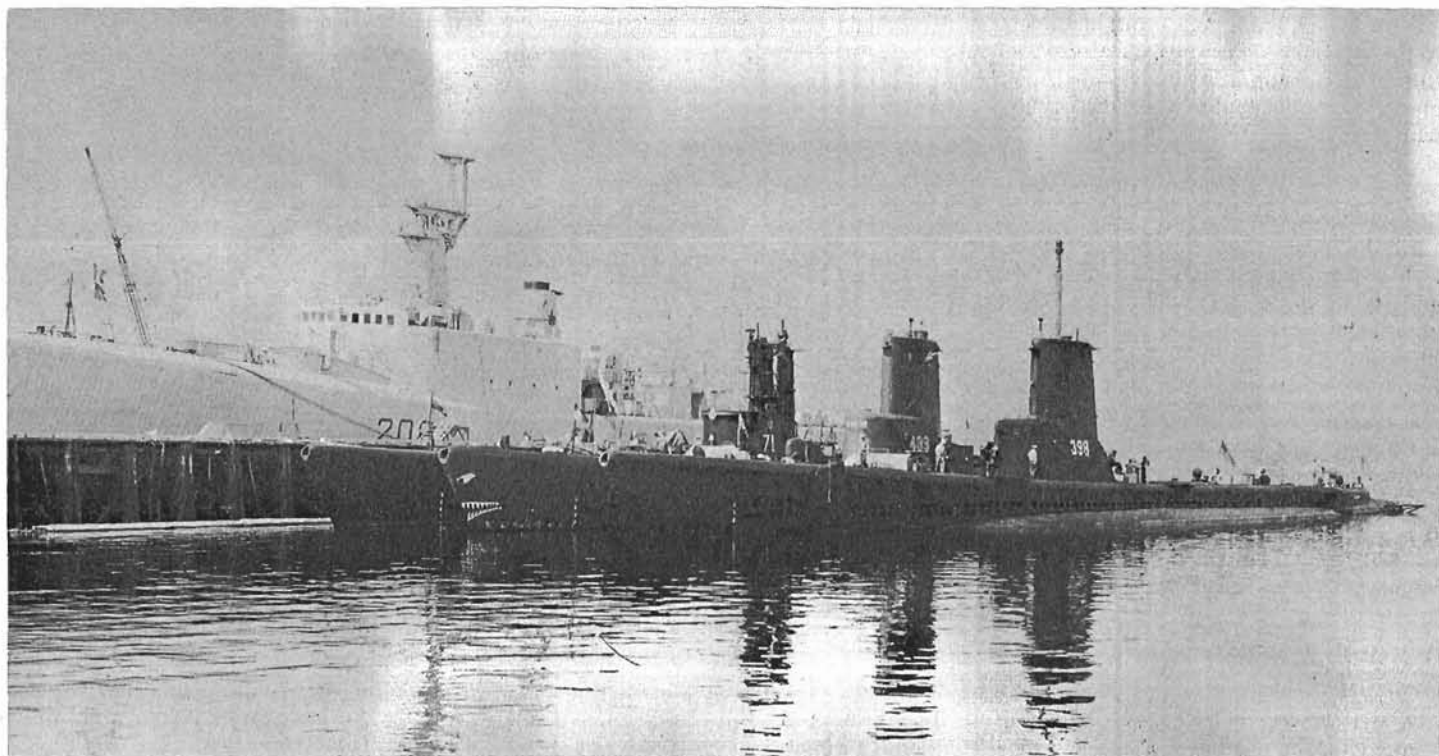

Esquimalt Harbour looked not unlike a submarine base early in September as two U.S. submarines, the *Spinax* and *Segundo*, joined HMCS *Gritse*. Nearly 3,500 persons visited the American submarines during a week-end open-house program. In the background is HMCS *Saguenay*. (E-73602)

RETIREMENTS

CPO MUNRO CHARLES BROOKES; C2WU4; served in RN, 1933 to 1948; joined RCN, Sept. 13, 1948; served in *Malahat*, *Naden*, *Stadacona*, *Magnificent*, *Haida*, *La Hullose*, *Huron*, *New Liskeard*, *Naden*, *Ontario*, *Ste. Therese*, *Jonquiere*, *Saguenay*; awarded Long Service & Good Conduct Medal; retired Sept. 12, 1963.

CPO THOMAS BERNARD CARTER, CD and 1st Clasp; C2BN4; served in RCN Sept. 13, 1937-Dec. 12, 1945; re-entered RCN Sept. 21, 1948; served in *Naden*, *Fraser*, *Ottawa*, *Restigouche*, *Comox*, *Venture*, *Stadacona*, *HMS Excellent*, *Niobe*, *Arrowhead*, *Hochelega*, *Westmount*, *Shediac*, *Dawson*, *Coppercliff*, *Avalon*, *Cornwallis*, *York*, *Discovery*, *Haida*, *Wallaceburg*, *La Hullose*, *Quebec*, *Cayuga*, *Queen*, *Beacon Hill*, *Venture*, *Jonquiere*; retired Sept. 20, 1963.

PO CHARLES LESLIE EHLER, P1ER4; joined RCNVR June 11, 1943, transferred to RCN Sept. 13, 1945; served in *Stadacona*, *Protector II*, *Cornwallis*, *Hochelaga II*, *Grou*, *Uganda*, *Quinte*, *Dundurn*, *Scotian*, *Iroquois*, *Portage*, *Cayuga*, *Athabaskan*, *Magnificent*, *La Hullose*, *Cabot*, *Huron*, *Prestonian*, *Toronto*, *New Liskeard*, *Buckingham*, *Swansea*, *Kootenay*, *Lauzon*, *Bonaventure*; retired Aug. 21, 1963.

CPO WILLIAM ELMORE ERICKSON, CD; C2ER4; joined RCNVR Sept. 7, 1943, transferred to RCN April 21, 1945; served in *Naden*, *Queen*, *Cornwallis*, *Stadacona*, *Avalon*, *Peregrine*, *Givenchy*, *Moncton*, *Prince Robert*, *Royal Roads*, *Ontario*, *Beacon Hill*, *New Glasgow*, *Fraser*, *Mallard*, *Micmac*, *Cape Breton*; retired Sept. 29, 1963.

CPO MARTIN BAUM GARDNER, C1MA4; joined Aug. 13, 1938; served in *Naden*, *Assiniboine*, *Stadacona*, *Ottawa*, *NOIC Saint John*, *Captor II*, *SNO Liverpool*, *Givenchy*, *Warrior*, *Ontario*, *Cornwallis*, *Malahat*, *Margaree*; awarded Long Service & Good Conduct Medal; retired Aug. 12, 1963.

CPO ROBERT STEEL GODDARD, CD; C2ER4; joined Aug. 4, 1943; served in *Star*, *Cornwallis*, *Stadacona*, *St. Clair*, *Scotian*, *Niobe*, *HMS Ferret*, *St. Laurent*, *Strathadam*, *Peregrine*, *Warrior*, *Montcalm*, *Iroquois*, *Swansea*, *Huron*, *New Liskeard*, *York*; retired Aug. 3, 1963.

PO CURTIS MacCUEN JOHNSON, P1SW3; joined Sept. 3, 1938; served in *Stadacona*, *Restigouche*, *Naden*, *Ottawa*, *Galt*, *Cornwallis*, *Niobe*, *Haida*, *Sioux*, *Captor II*, *Brunswick*, *York*, *Iroquois*, *Sans Peur*, *Scotian*, *Athabaskan*, *Swansea*, *CANAS Dartmouth*, *Magnificent*, *Portage*, *Shearwater*, *Haida*, *Saguenay*, *Crusader*, *Fort Erie*, *Crescent*; awarded Long Service & Good Conduct Medal; retired Sept. 2, 1963.

CPO ALBERT JOHN LEWIS, CD; C2WS4; joined July 15, 1941; served in Regina naval division, *Naden*, *Q066*, *Prince Robert*, *Givenchy*, *Lockeport*, *Stadacona*, *Clayoquot*, *HMS Waldegrave*, *Niobe*, *Kootenay*, *Cornwallis*, *Peregrine*, *Micmac*, *Scotian*, *Diving Tender No. 4*, *Sans Peur*, *Iroquois*, *Haida*, *Nootka*, *Magnificent*, *Buckingham*, *Iroquois*, *Wallaceburg*, *Shearwater*, *Huron*, *Point Edward Naval Base*; retired August 5, 1963.

CPO MURRAY JACK MASON, CD; C1AT4; joined RCNVR June 1, 1942, transferred to RCN Aug. 24, 1944; served in *Star*, *Naden*, *Givenchy*, *Nonsuch*, *Stadacona*, *Niobe*, *RNAS Worthy Down*, *HMS Merlin*, *HMS Kestrel*, *HMS Merganser*, *Peregrine*, *HMS Daedalus*, *Warrior*, *HMS Ringtail*, *RCNAS Dartmouth (826 Sqdn)*, *Magnificent (18CAG)*, *Shearwater*, *Cornwallis*, *30CAG*, *VF871*, *12TSU Toronto*, *Griffon*, *York*, *Shearwater*, *Naden (VU33)*; retired September 3, 1963.

PO GEORGE FREDERICK McGREGOR, P1BN2; served in RCNVR June 10, 1936 to Sept. 20, 1945; joined RCN Dec. 24, 1945;

served in *Stadacona*, *Protector*, *Cornwallis*, *Peregrine*, *Scotian*, *Haligonian*, *RCNAS Dartmouth*, *Warrior*, *Iroquois*, *La Hullose*, *Magnificent*, *Shearwater*, *Bonaventure*; retired September 21, 1963.

CPO JACK PEAKMAN, CD; C1ER4; joined RCNVR July 8, 1935, transferred to RCN Jan. 9, 1940; served in Calgary naval division, *Naden*, *Nootka*, *Stadacona*, *Restigouche*, *Goderich*, *Niobe*, *HMS Bulldog*, *Iroquois*, *Scotian*, *Uganda*, *Givenchy*, *Rockcliffe*, *Ontario*, *Kentville*, *Crescent*, *Antigonish*, *Churchill*, *Cape Breton*; retired August 18, 1963.

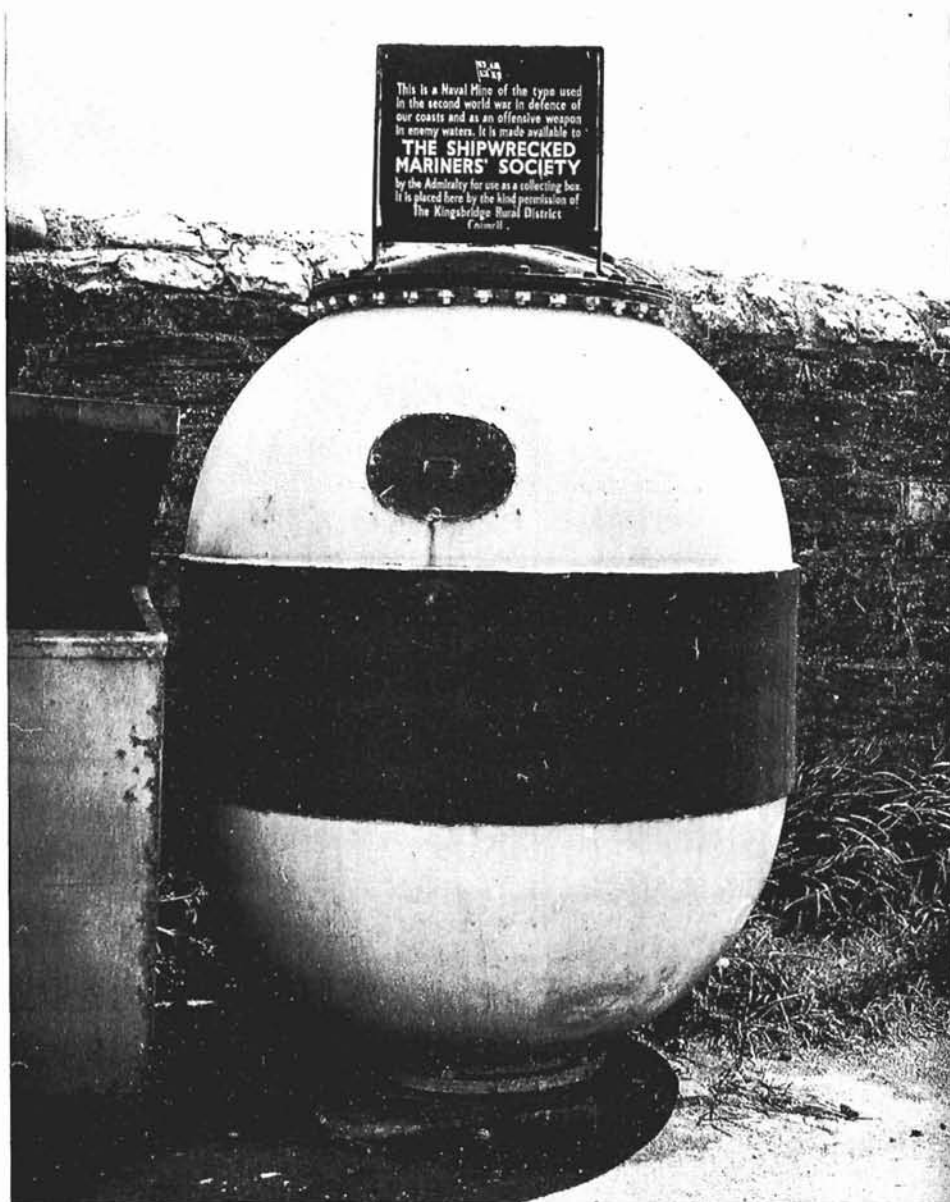

What may be an improvement on the idea of beating swords into ploughshares is illustrated by this picture taken in Hope Cove, near Kingsbridge, Devon, England, by Lt.-Cdr. Ernest H. Bartlett, RCNR (Ret), travel editor of *The Telegram*, Toronto. The plaque reads: "This is a Naval Mine of the type used in the Second World War in defence of our coasts and as an offensive weapon in enemy waters. It is made available to The Shipwrecked Mariners' Society by the Admiralty for use as a collecting box. It is placed here by the kind permission of The Kingsbridge Rural District Council".

CPO RICHARD FRANK POLLY, C2WS4; joined April 17, 1939; served in *Stadacona*, *Venture*, *Skeena*, *HMS Drake*, *Cornwallis*, *Niobe*, *HMS Excellent*, *Glasgow*, *Uganda*, *Naden*, *Warrior*, *Rockcliffe*, *Ontario*, *Bytown*, *Niagara*, *Sioux*, *Athabaskan*, *Beacon Hill*, *Jonquiere*; awarded Long Service & Good Conduct Medals; retired August 23, 1963.

CPO KEITH ARTHUR TOLL, CD; C1ER4; joined RCNVR May 12, 1942, transferred to RCN March 20, 1944; served in *Prevost*, *Star*, *Naden*, *Givenchy*, *York*, *Stadacona*, *Avalon*, *Humberstone*, *Cornwallis*, *Beacon Hill*, *Port Hope*, *Peregrine*, *Sault Ste. Marie*, *Oshawa*, *Givenchy*, *Ontario*, *Magnificent*, *Crusader*, *Fraser*, *Assiniboine*; retired September 4, 1963.

PO EDWIN JOHN WALSH, CD; PIRP3; joined RCNVR Aug. 13, 1943, transferred to RCN Apr. 12, 1945; served in *Stadacona*, *Montcalm*, *Cornwallis*, *Iroquois*, *St. Hyacinthe*, *Peregrine*, *Uganda*, *Scotian*, *Nootka*, *Lloyd George*, *New Liskeard*, *Swansea*, *Magnificent*, *Portage*, *Wallaceburg*, *Shearwater*, *Assiniboine*, *Terra Nova*; retired September 1, 1963.

OFFICERS RETIRE

LT.-CDR. ALEXANDER ALLAN BEVERIDGE, CD; served in RCNVR March 3 1941, to April 11, 1946; entered the RCN(R) active list, November 7, 1947; transferred to RCN September 23, 1948; entered RCNVR as a probationary writer; promoted to probationary paymaster sub-lieutenant on October 18, 1944; served in *Cornwallis*, *Bytown*, *Donnacona*, *Cataraqui*, *Naden*, *Shearwater*, *Niobe*, *Hochelaga*, *Magnificent*, *Micmac*, *Bonaventure*, *Assiniboine*, *Haida*, *Fort Ramsay*, *Avalon*, *Stadacona*, *Patriot*; last appointment *Patriot*, on staff of Commanding Officer Naval Divisions as Secretary and as Flag Lieutenant-Commander; commenced leave on July 31, 1963; retires on December 14, 1963.

LT.-CDR. JACK DOUGLAS, CD; joined RCNVR on May 16, 1941, as an ordinary seaman; promoted to probationary sub-lieutenant on April 27, 1942; demobilized September 30, 1947; entered RCN, March 1, 1952; Lt.-Cdr. Douglas served in *Stadacona*, *Halifax*, *Royal Roads*, *Givenchy*, *Burrard*, *Ingonish*, *Naden*, *Discovery*, *Rockcliffe*, *Antigonish*, *Cornwallis*, *Iroquois*, *Bytown*, *Assiniboine*; last appointment *Naden*, on staff of Commodore Superintendent Pacific Coast for Engineering Department Ship Repair Activity; commenced leave on August 17, 1963; retires on November 21, 1963.

CHAPLAIN (P) FREDERICK HODGSON GODFREY; joined RCN August 29, 1942, as Chaplain (temp); served in *Stadacona*, *Chatham*, *Naden*, *Givenchy*, *Niobe*, *Peregrine*, *Ontario*, *Cornwallis*, *Algonquin*, *Magnificent*, *Shearwater*, *Bonaventure*; last appointment *Cornwallis*, as Senior Chaplain (P); commenced leave on July 27, 1963; retires on January 29, 1964.

SURGEON COMMANDER MARCUS HARVEY LITTLE, CD; joined RCNVR April 30, 1942, as a probationary surgeon-lieutenant; transferred to RCN, April 18, 1946; served in *Stadacona*, *Warrior*, *Bytown*, *Donnacona*, *Quebec*, *Niobe*, *Cataraqui*; last appointment *Cataraqui*, for Canadian Forces' Hospital, Kingston, as anaesthesiologist with acting rank of surgeon captain; commenced leave on August 1, 1963; retires on February 3, 1964.

CDR. RAYMOND STERNBERG MARTIN, CD; joined RCNVR September 11, 1944, as a probationary sub-lieutenant (SB); transferred to the RCN, July 11, 1946; served in *Carleton*, *Cornwallis*, *Bytown*, *Unicorn*, *Stadacona*, *Naden*, *Ontario*; last appointment *Naden*, as Officer-in-Charge Academic Division and on staff of Flag Officer Pacific Coast as Command Education Officer; commenced leave on August 1, 1963; retires on December 26, 1963.

LT.-CDR. ERLING ALBERT PRESCOTT, CD; joined RCNVR September 10, 1940, as a victualling assistant; promoted to warrant officer (SB) on September 1, 1942; de-

mobilized November 3, 1945; entered the RCN(R) December 8, 1949; transferred to the RCN December 28, 1951; served in *Avalon*, *Givenchy*, *Naden*, *Stadacona*, *Cabot*, *Cornwallis*, *York*, *Nonsuch*, *Quadra*, *Patriot*; last appointment *Patriot*, on staff of Command Officer Sea Cadets as Deputy Command Sea Cadet Officer; commenced leave on August 21, 1963; retires on November 26, 1963.

LT.-CDR. STANLEY THOMAS RICHARDS, CD; joined RCN October 19, 1933, as a probationary sick bay attendant; promoted to acting warrant wardmaster, on June 1, 1942; served in *Naden*, *Burrard*, *Protector*, *Bytown*, *HMS Haslar*, *HMS Victory II*,

Skeena, *Ottawa*; last appointment Naval Headquarters, on staff of Surgeon General for Director Medical Plans and Requirements; commenced leave on August 26, 1963; retires on April 20, 1964.

CDR. WILFRED EWART SMITH, CD; joined RCNVR February 23, 1942 as a Sub-Lieutenant (SB); transferred to RCN, November 14, 1945; served in *York*, *Stadacona*, *Hochelaga*, *Bytown*, *Avalon*, *Poundmaker*, *Scotian*, *Nootka*, *Magnificent*, *Naden*; last appointment Naval Headquarters, on staff of Director Marine and Electrical Engineering (Electrical Engineering); commenced leave on August 5, 1963; retires on February 7, 1964.

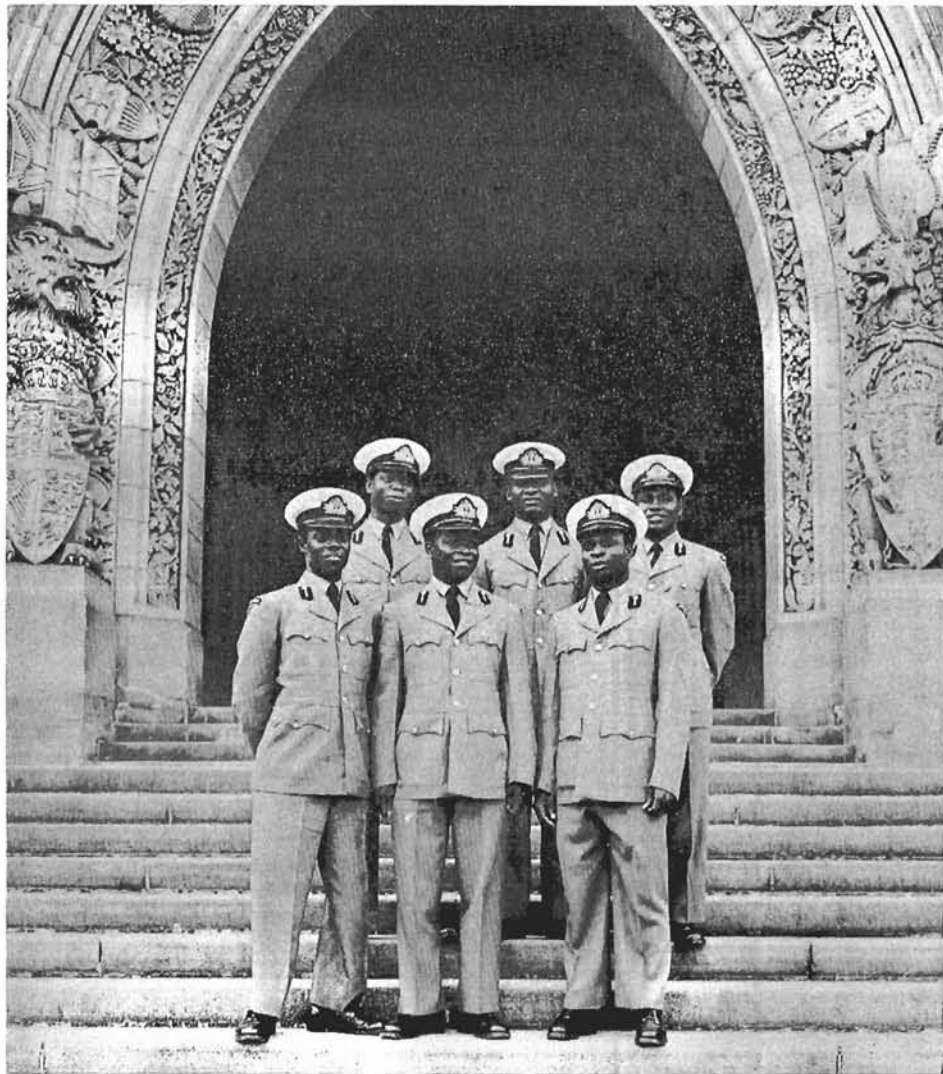

Six Nigerian officer cadets, who began their training at HMCS *Venture* a year ago, paid a mid-summer visit to Ottawa and are seen here on the steps of the Centre Block of the Parliament Buildings. (O-15129)

LOWER DECK PROMOTIONS

Following are lists of men selected by Naval Headquarters for promotion. These selections are subject to confirmation by the RCN Depot and the concurrence of the commanding officer in each case. The effective date of promotion is June 1, 1963. Names are grouped according to trade.

Pacific Command

For Promotion to Chief Petty Officer First Class

C2BN4 Miller, I. W.....431B-E
C2SN4 Watson, R. B.....9671-E
C2RP4 Cooke, R. E.....5399-E
C2SG4 King, J. W.....5096-E
C2ER4 Pepper, C. J.21709-E
C2ET4 Jenkins, C. F.....3801-E
C2HT4 Raines, W. F.....51832-E
C2ST4 Gardner, A. F.....18344-E
C2CM4 Rodgers, J.....40619-E

For Promotion to Chief Petty Officer Second Class

P1BN4 Breen, G. H.....4992-E
P1WS3 Donaldson, G. B.....3900-E
P1FC4 Boon, R. J.....23800-E
P1WU4 Bottomley, B. R.....6724-E
P1WU4 Hogg, A.....23272-E
P1SN4 Millan, F.....2711-E
P1SG4 Gornouk, W. A.....11124-E
P1SG3 Olynick, A. G.5913-E
P1SG4 Wyatt, S. H.3619-E
P1RM3 Rands, H. A.....5747-E
P1ER4 Earnshaw, I. W.....9764-E
P1ER4 Harding, F. E.....9693-E
P1ER4 Luining, A. L.....22574-E
P1ER4 McGowan, H. A.....24045-E
P1ET4 Hamilton, D. W.....10275-E
P1LT4 Hill, S. W.....9973-E
P1HT4 Day, R. H.....9762-E
P1NS3 Rourke, D. J.....9928-E
P1CM4 Campsall, J. E.....8282-E
P1CD4 Ackerman, G. W.....4482-E

For Promotion to Petty Officer First Class

P2BN3 Bannerman, R. D.....5665-E
P2WS3 Cook, F. C.10292-E
P2FC4 Young, J. E.17311-E
P2WU4 Crowe, D. J.16797-E
P2SN3 Cathcart, D. S.....10377-E

P2SN3 Mackie, W. A.....24221-E
P2SN3 Pinard, J. B.....8698-E
P2RP3 Peterson, D. M.....14717-E
P2SG3 Semple, W. E.16200-E
P2RM3 Bellefontaine, E. J.12155-E
P2RM3 Freeman, G. F.....11182-E
P2RM3 Norman, G. M.....17077-E
P2RM3 Smith, W. M.....10991-E
P2RM3 Stephens, W. R.....6822-E

P2ER4 Bird, R. H.....7708-E
P2ER4 Yurgensen, W. G.....35262-E

P2ET3 Marshall, D. V.....14940-E

P2LT4 Clouston, W. J.....7993-E
P2LT4 Corder, E. J.....17205-E

P2HT4 Perron, G. E.....8027-E

P2NS3 Neal, C. F.....11798-E

P2CK3 Langlois, H. F.....9555-E

P2SW3 Klee, H. K.....51566-E
P2SW3 Smithson, G.....10325-E

P2MA4 Ames, R. K.....17096-E

P2BD3 Lothar, P. W.....50543-E

Atlantic Command

For Promotion to Chief Petty Officer First Class

C2BN4 Wachowicz, A.4712-H
C2WS4 Bourret, H.....51440-H
C2FC4 Morrison, R. C.....5443-H
C2WU4 Buckland, J. R.....4517-H
C2SN4 Allday, B. J.....6627-H
C2RP4 Meadwell, J. G.....4981-H
C2SG4 McKellar, I. M.....4412-H
C2RM4 Layton, J. L.....4692-H
C2ER4 Bonner, L. R.....50635-H
C2ER4 Graham, C. E.....19522-H
C2ER4 Lennox, N. W.....14465-H
C2ET4 Reid, A. G.....6385-H
CC2LT4 Wings, G. H.....51464-H

C2HT4 Whitman, G. S.....51018-H
C2NA4 Saunders, J. E.....6906-H
C2AT4 Acquanno, F.....50301-H
C2WR4 Lambert, L. B.....50251-H
C2ST4 Jenkins, D. H.....5529-H
C2CM4 Marchment, G. R.....50558-H
C2CM4 Stevens, B. C.....51031-H
C2LA4 Joyce, F.....51538-H
C2MA4 Macdonald, J. J.....51724-H

For Promotion to Chief Petty Officer Second Class

P1BN4 Borgal, G. G.....3727-H
P1WS4 Derrick, J. H.....11627-H
P1WS3 Moffat, H. C.....7070-H
P1FC4 Donkin, C. F.....12100-F
P1WU4 Leger, J. W.....6569-H
P1WU4 Thorne, C. R.....51571-H
P1SN4 Diamond, A. J.....27158-H
P1RP4 McBride, F. C.....12305-H
P1RP4 McQuestion, R. J.....11512-H
P1RP4 Parise, E. J.....6414-H
P1RP4 Spence, K.12065-H
P1SG4 Beaver, K. J.....12058-H
P1SG4 Griffith, A. W.....11388-H
P1SG4 Martin, J. M.....10830-H
P1SG4 McGrath, S. J.....12106-H
P1RM3 Exley, E. W.....10523-H
P1ER4 Bauer, W. H.....10729-H
P1ER4 Cooper, L. E.....9257-H
P1ER4 Dawson, A. R.....9507-H
P1ER4 Dowhey, S.4937-H
P1ER4 Dunbar, W. E.....22423-H
P1ER4 Golden, K. V.....22442-H
P1ER4 Mackin, W. A.....22665-H
P1ER4 McKinley, R. N.....34260-H
P1ER4 Pattison, C. D.....25629-H
P1ER4 Self, R. H.....30597-H
P1ER4 Vanderpe, R. H.....29071-H
P1ET4 Dunbar, G. H.24922-H
P1ET4 Kramer, F. G.....11294-H
P1ET4 Macdonald, C.....12293-H
P1LT4 Green, J. E.....11924-E



P1HT4	Shedlowski, R.....	6451-H
P1NA4	Bonneau, J. L.....	11360-H
P1AM3	Leclerc, J. C.....	5900-H
P1AT4	Davis, D. R.....	50646-E
P1AT4	Greenwood, H. M.....	50833-H
P1EA3	Abbott, R. P.....	51842-H
P1RA4	Miller, S. R.....	1174-E
P1AW3	Lovett, W. A.....	6748-H
P1CM4	Carmichael, R. J.....	10512-H
P1LA4	Applejohn, R. H.....	51458-H
P1RR4	Dalglish, T. E.....	7391-H
P1HA4	Fortin, E. B.....	9914-E
P1CD4	Robinson, B. W.....	13201-H
P1MO4	Pilger, C. V.....	8673-H

*For Promotion to
Petty Officer First Class*

P2BN3	Farrell, C. S.....	12154-E
P2BN3	Thompson, J. J.....	13049-H
P2WS3	McLeod, W.	25506-H
P2WS3	Sheehy, R.....	10591-H
P2FC3	Pouliot, L. P.....	16344-H
P2WU3	Allison, R. J.....	35655-H
P2WU4	Ambrose, P. J.....	28271-H
P2WU3	Anderson, J. C.....	24521-H
P2WU3	Burke, G. A.....	12362-H
P2WU3	Guinchard, R. H.	13621-H
P2WU3	Leslie, A.....	14163-H
P2WU4	McGregor, R. H.....	19618-H
P2SN3	Blondin, R. G.....	18081-H
P2SN4	Campbell, G. A.....	18223-H
P2SN3	Clark, R. B.....	14551-H
P2SN3	Doubleday, H. E.....	12294-H
P2SN3	Howe, R.....	25398-H
P2SN3	Long, M. A.....	11467-H
P2SN3	Morgan, C. E.....	26949-H
P2SN3	Paquette, J. E.....	13421-H
P2RP3	Rycroft, V. S.....	8815-H
P2SG3	Aggett, R. G.....	16477-H
P2SG3	Bohn, T. E.....	11613-H
P2SG3	Forbes, J. A.....	24097-H
P2SG3	Gerrard, W. T.....	10924-H
P2RM3	Campbell, G. E.....	13077-H
P2RM3	Cruddas, J. J.....	18149-H
P2RM3	Dawson, G. A.....	13536-H
P2RM3	Foote, P.....	13725-H
P2RM3	Titford, C. W.....	11822-H
P2ER3	Allen, M. H.....	16183-H
P2ER4	Barr, P. J.....	12562-H
P2ER4	Backett, R. D.....	24543-H
P2ER3	Bell, C. A.....	11877-H
P2ER3	Bergeron, P. J.....	28449-H
P2ER3	Black, W. R.....	16699-H
P2ER3	Blommaert, A. J.....	14470-H
P2ER4	Bruce, W. E.....	16011-H
P2ER3	Canniff, P. J.....	39161-H
P2ER4	Cavana, J. W.....	26453-H
P2ER4	Ciappara, N.....	39116-H
P2ER4	Conners, M. R.....	14573-H
P2ER3	Crawford, C. C.....	16140-H
P2ER4	Currie, R. L.....	15736-H
P2ER3	Freeman, P. D.....	13590-H
P2ER3	Gamelin, S. O.....	16022-H
P2ER3	Grenier, J. O.....	14053-H
P2ER3	Grist, C. B.....	19955-H
P2ER4	Hamer, C. A.....	25461-H
P2ER3	Hardy, M. J.....	32076-H
P2ER4	Harnett, W. N.....	14558-H

P2ER3	Harrett, C. G.....	30573-H
P2ER3	Haynes, J. H.....	13565-H
P2ER4	Hill, M. J.....	26230-H
P2ER3	Hill, K. M.....	25030-H
P2ER3	Igoe, J. M.....	25471-H
P2ER3	Jackson, R. H.....	7341-H
P2ER4	Jenns, G. S.....	23249-H
P2ER4	Jessiman, H. R.....	7223-H
P2ER3	Johnston, J.....	18231-H
P2ER4	Jones, B. E.....	22302-H
P2ER3	Jones, S. H.....	10224-H
P2ER4	Kaye, R. L.....	10731-H
P2ER3	Kohls, E. W.....	11896-H
P2ER3	Lacroix, R. G.....	22430-H
P2ER4	Leal, E. R.....	29995-H
P2ER4	Legard, L. A.....	26274-H
P2ER4	Loughran, G. J.....	38396-H
P2ER4	Mackenzie, J. R.....	26095-H
P2ER3	Mackintosh, R. M.....	12349-H
P2ER4	McCulloch, J. C.....	11532-H
P2ER4	McIntyre, C. H.....	7347-H
P2ER4	E. B. McIntyre.....	18099-H
P2ER4	McLaughlin, J. D.....	16807-H
P2ER4	Morris, J. D.....	16116-H
P2ER4	Pennell, D. J.....	13693-H
P2ER4	Poidevin, J. J.....	16115-H
P2ER4	Rabideau, F.....	19937-H
P2ER4	Rae, D. W.....	7270-H
P2ER4	Reid, R. J.....	9103-H
P2ER4	Riddiford, D. B.....	26716-H
P2ER3	Ryan, E. T.....	43334-H
P2ER4	Smith, W. C.....	25168-H
P2ER3	Trudeau, A. J.....	13400-H
P2ER4	Upcott, G. B.....	18091-H

P2ER4	Urquhart, I. A.....	25045-H
P2ER3	Whittaker, V. P.....	9218-H
P2ER4	Wiens, F. N.....	10880-H
P2ER3	Wright, W. A.....	10899-H
P2ET4	Lauzon, R. J.....	24540-H
P2ET4	Watkins, P. D.....	9364-H
P2LT4	Beaupre, G. R.....	26381-H
P2LT4	Bessem, N. I.....	17610-H
P2LT3	Harvie, R. M.....	15937-H
P2LT3	McNaughton, G. W.....	26940-H
P2LT4	Reed, N. W.....	31255-H
P2LT4	Simmons, D. C.....	25922-H
P2WA3	Baldwin, C. W.....	13354-H
P2NA4	Brooks, D. C.....	7933-H
P2NA3	Greenbury, R. B.....	16063-H
P2AM3	Labrie, J. L.....	9904-H
P2AT3	Smethurst, W. E.....	15814-H
P2AT3	Snooks, F. E.....	13600-H
P2AT3	Stapleford, G. D.....	25392-H
P2EA4	Mercer, C. E.....	19253-H
P2RA4	Bailey, C. J.....	10711-E
P2RA4	Ley, C. T.....	24965-H
P2AW3	Penwaren, R. H.	12287-H
P2PW3	Blackbeard, D. G.....	15861-H
P2VS3	Taggart, R. A.....	13255-H
P2NS3	Paradis, J. H.....	9863-H
P2CK3	Palmer, J.....	50680-H
P2CK3	Stafford, R. D.....	12308-H
P2SW3	Hounsell, L.....	13549-H
P2MA3	Beaudry, J. A. R.....	18554-H
P2MA4	Evans, P. J.....	31226-H
P2MA4	Lallier, J. J.....	17974-H
P2MA3	Lee, G. A.....	32960-H
P2CD3	Cripps, I. R.	16617-H
P2PT3	Shanks, R. F.....	11736-H
P2BD3	Fisher, R. E.....	10119-H
Wrens		
<i>For Promotion to Petty Officer First Class</i>		
P2MX3	Rowley, G. I.....	W-36433
Supplementary Radio Stations		
<i>For Promotion to Chief Petty Officer Second Class</i>		
P1RS4	Eckstein, B. C.....	5704-G
P1RS4	Hudson, N. R.....	5133-G
P1RS4	Krafft, K. E.....	6217-G
P1RS4	Lamorie, R. N.....	13012-G
P1RS4	Lacellan, R. J.....	12216-G
P1RS4	Todd, G. D.....	14326-G
<i>For Promotion to Petty Officer First Class</i>		
P2RS3	Campbell, E. E.....	14545-G
P2RS3	Dodd, N. G.....	9207-G
P2RS3	Gouchie, K. J.....	143503-G
P2RS3	Lane, G. H.....	11802-G
P2RS3	Perry, N. A.....	10887-G
P2RS3	Ward, G. R.....	18904-G

LETTER

Sir:

The article "The New Hydrofoil" in the July issue of *The Crownsnest* draws attention to the prospect that in a few years a valuable new type of ship may be available for service in the RCN and other navies, thanks to Canadian technical initiative and foresight, backed up by a substantial research and development effort. The Defence Research Board and its Naval Research Establishment, aided all along by enthusiastic support from RCN technical officers, are pleased to deserve a large share of the credit for the progress to date. But, having been the Chief Superintendent of NRE in 1951 when that laboratory took over responsibility for conducting experiments with the 45-foot hydrofoil boat, *Massawippi*, I feel it should be recognized that major credit for initially arousing the interest of DRB in the naval potential of hydrofoil craft belongs to the *Massawippi's* owner, Cdr. D. M. Hodgson, RCNR, of Montreal, whose personal resource and effort sustained experimentation with hydrofoils at a time when it would otherwise surely have expired.

Yours sincerely,

J. E. KEYSTON
Vice-Chairman,
Defence Research Board

OTTAWA

Naval Lore Corner

Number 120 LINERS AT WAR

MANY FAST LINERS "JOINED THE NAVY" EARLY IN BOTH WORLD WARS TO SERVE AS ARMED MERCHANT CRUISERS (AMCs). THEY WERE ARMED AND USED TO PATROL THE SEA LANES AND TO PROTECT CONVOYS FROM RAIDERS. WHEN THIS THREAT WAS ELIMINATED THEY WERE CONVERTED TO OTHER EMPLOYMENT...



THE 460-FOOT BLUE FUNNEL LINER "MENESTHEUS" WAS ORIGINALLY EMPLOYED AS A MINELAYER (RIGHT) AND SAW SERVICE IN ENEMY WATERS. IN 1945 SHE WAS CONVERTED (IN VANCOUVER) INTO AN "AMENITIES" SHIP FOR THE BRITISH FORCES IN THE PACIFIC (ABOVE). MANNED BY THE M.N., HER FACILITIES INCLUDED A 400-SEAT THEATRE, BREWERY AND FEMALE FORCES QUARTERS. HER FORE FUNNEL WAS A DUMMY...

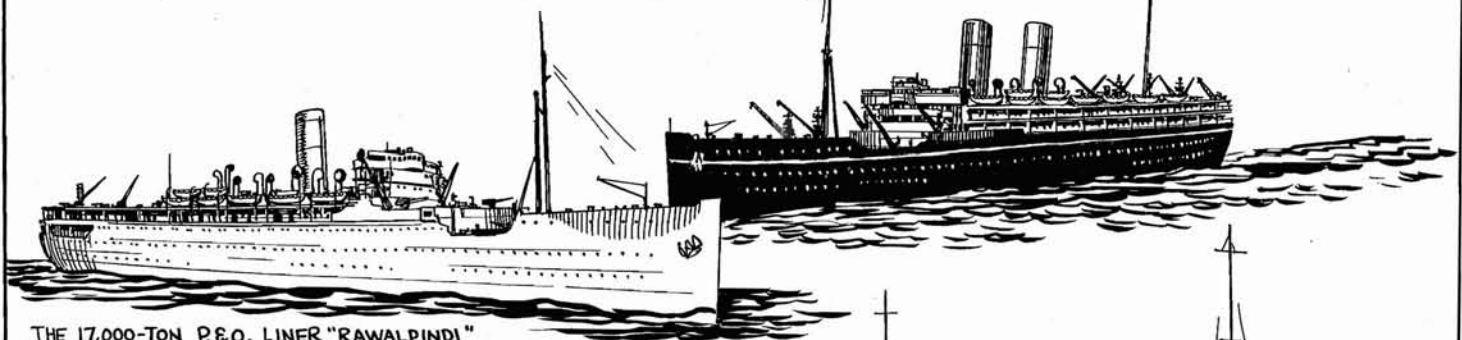

THE 17,000-TON P&O LINER "RAWALPINDI" (FAR RIGHT) WAS ONE OF THE FIRST LINERS IN WORLD WAR II TO BE CONVERTED INTO AN 'AMC' (ABOVE) ... AND ONE OF THE MOST GALLANT. SHE SINGLE-HANDEDLY ENGAGED THE GERMAN BATTLECRUISERS 'GNEISENAU' AND 'SCHARNHORST' WHILE ON PATROL IN THE DENMARK STRAIT WITH HER EIGHT WORLD WAR I 6-INCH GUNS, AND SANK WITH HER GUNS BLAZING...

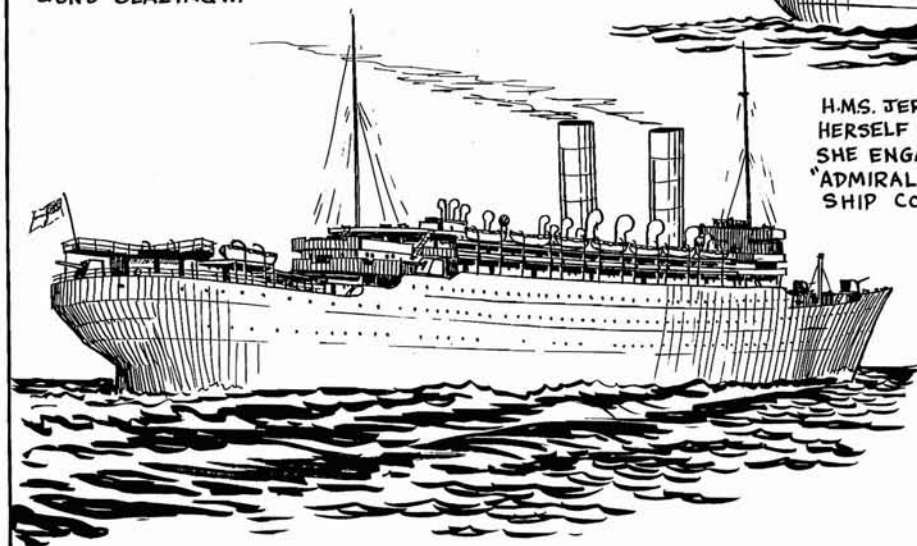

H.M.S. JERVIS BAY (ABOVE) GLORIOUSLY SACRIFICED HERSELF ON 5 NOV., 1940 IN MID-ATLANTIC AS SHE ENGAGED THE GERMAN POCKET BATTLESHIP "ADMIRAL SCHEER", THEREBY ENABLING HER 37-SHIP CONVOY TO DISPERSE. 22 REACHED PORT...

IN WORLD WAR I, THE EX-CUNARDER H.M.S. CARMANIA (LEFT) (19,500 TONS), AN AUXILIARY CRUISER WITH EIGHT 4.7-INCH GUNS, ENGAGED THE GERMAN HAMBURG-AMERIKA LINER "CAP TRAFALGAR", 18,500 TONS (A RAIDER DISGUISED AS AN UNION CASTLE LINER) ON 14 SEPT., 1914 OFF THE COAST OF BRAZIL. THEY FOUGHT A SHARP BATTLE IN WHICH BOTH SIDES FOUGHT GALLANTLY. THE "CAP TRAFALGAR" (TWO 4.1-INCH GUNS, 6 POM-POMS) FINALLY ROLLED OVER AND SANK. H.M.S. CARMANIA LIMPED BACK TO GIBRALTER...

Roger Duhamel

QUEEN'S PRINTER—IMPRIMEUR DE LA REINE

M. E. DIXON,
CONT. OF OFFICES SERV., &
SUPPLIES, DEPT. OF NAT'L
DEFENCE, 126 ELGIN ST.,
OTTAWA, ONT. CRO.F.

If undelivered return to:

The Queen's Printer, Ottawa, Canada

En cas de non-livraison, retourner à:

L'Imprimeur de la Reine, Ottawa, Canada



The CROWSNEST

NATIONAL LIBRARY
DEC 17 1963
LIBRARY

C 5 L. 6

Vol. 15 Nos. 10 and 11

October - November, 1963

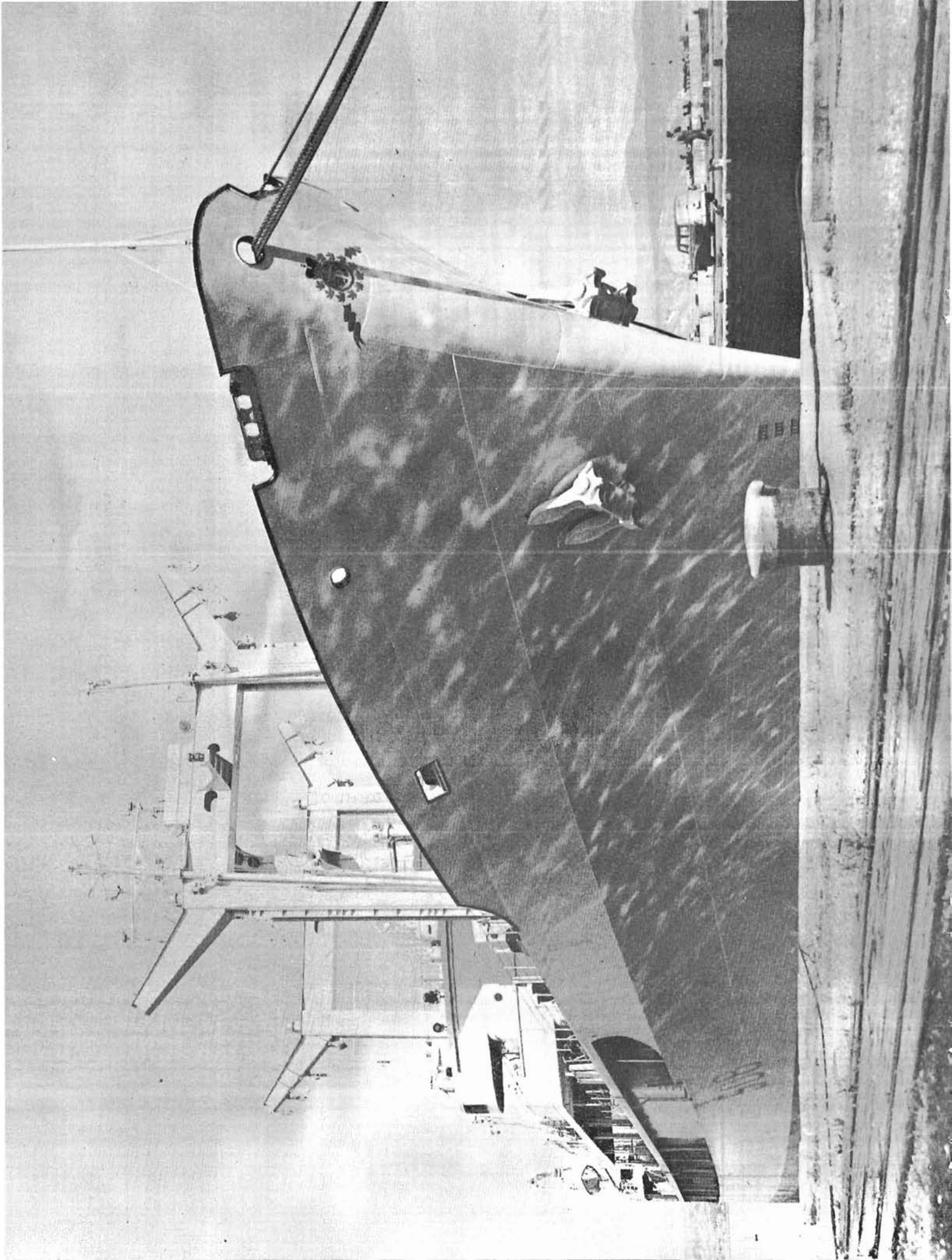

The CROWSNEST

Vol. 15 Nos. 10 and 11 THE ROYAL CANADIAN NAVY'S MAGAZINE OCTOBER - NOVEMBER 1963

CONTENTS

	Page
<i>Three Statements</i>	2
<i>RCN News Review</i>	4
<i>HMCS Provider</i>	7
<i>Arrivederci, Roma</i>	10
<i>Officers and Men</i>	11
<i>Weddings and Births</i>	11
<i>HMCS Qu'Appelle</i>	14
<i>Afloat and Ashore</i>	17
<i>Home from the Sea</i>	21
<i>Guz and the Oggies</i>	23
<i>Here and There in the RCN</i>	25
<i>Tri-Service Medical Training</i>	27
<i>Flagship at Halifax</i>	28
<i>Books for the Sailor</i>	31
<i>Perforated Wharf</i>	34
<i>Retirements</i>	35
<i>Naval Lore Corner No. 121</i>	<i>Inside Back Cover</i>

The Cover—Some indication of the impressive size of HMCS *Provider* is given in this picture, taken shortly before her commissioning at Lauzon, Quebec, on September 28. Ready for sea, she will sit nearly 15 feet lower in the water than shown here. ML-12839)

LADY OF THE MONTH

When HMCS *Provider* puts to sea with the fleet, she will give Canada's warships a new mobility, enabling them to remain on operational duty for long periods in distant waters. All 22,000 tons of her have been designed with a view to fuelling and supplying ships at sea expeditiously and while travelling at high speed.

The photograph on the opposite page, taken just a short time before her commissioning on the beautiful autumn day of September 28 (the sun-dappled hull bears witness to the fine weather), shows the naval badge that was painted on the bow to proclaim her a naval vessel even before the White Ensign was hoisted.

She will not be armed, but her store-rooms, tanks and magazines will carry the sinews of war. (ML-12859)

Negative numbers of RCN photographs reproduced in *The Crowsnest* are included with the caption for the benefit of persons wishing to obtain prints of the photos.

This they may do by sending an order to the Naval Secretary, Naval Headquarters, Ottawa, attention Directorate of Naval Photography, quoting the negative number of the photograph, giving the size and finish required, and enclosing a money order for the full amount, payable to the Receiver General of Canada.

Sizes, finish and the National Defence standardized prices, follow:

4 x 5 (or smaller) glossy finish only ..	\$.10
6½ x 8½ glossy finish only40
8 x 10 glossy or matte finish50
11 x 14 matte finish only	1.00
16 x 20 " " "	3.00
20 x 24 " " "	4.00
30 x 40 " " "	8.00

SUBSCRIPTION RATE

The Crowsnest may be subscribed for at the rate of \$2 a year; outside of North America, \$3. Orders, accompanied by cheque or money order payable to the Receiver General of Canada, should be sent to:

THE QUEEN'S PRINTER,
Department of Public Printing
and Stationery,
OTTAWA, Ontario

Communications, other than those relating to subscriptions, should be addressed to:

EDITOR,
The Crowsnest,
Naval Headquarters,
OTTAWA, Ontario.

THREE STATEMENTS OF VITAL CONCERN

1. *The Position of the Royal Canadian Navy*

Current naval issues and problems were discussed by Vice-Admiral H. S. Rayner, Chief of the Naval Staff, in a general message (CANGEN 221) despatched to the Fleet November 1. The text of this message follows:

NATIONAL DEFENCE policy is being widely discussed these days in political and military circles, on radio and television, in the press across the land, in your messes in ships and shore establishments, in your workshops and offices, and in your homes.

In this atmosphere many of the real issues and facts are apt to be lost in the maze of rumour, half truths and sheer speculation. This in turn, I feel sure, is causing some confusion and concern and it is for this reason that I would like to bring you up to date with happenings as I see them today.

On Tuesday, July 9, I appeared before the House of Commons special committee on defence to explain to the committee the purpose, role and tasks of the navy, the Royal Canadian Navy as it is to-day and some possibilities for the future. At that time I stated that in the present RCN we have an effective, modern navy with a sound base for future growth.

I want to repeat that statement to-day to the officers, men and women of the RCN, the RCNR and to the thousands of civilians who are immediately concerned in the day to day functioning of the Royal Canadian Navy.

On Tuesday, October 15, I appeared again before the House of Commons committee on defence to reject publicly some grave charges levelled against the Navy by a retired officer and to confirm to this committee and to the people of Canada my firm belief that the Navy is efficient and that the performance of our ships on operations in recent years has stood up well in comparison with ships of other navies.

The Minister of National Defence has announced in the House of Commons that the government is in the process of reviewing the entire field of Canadian defence policy and is examining all major alternatives with regard to the shape and size of the Canadian Armed Forces in order that the final configuration would most effectively meet our national needs.

On October 26 the Minister announced that one outcome of this review was the cancellation of the general purpose frigate building program. As you will have read in CANGEN 214, the Minister made it quite clear that this did

not mean the end of the navy's ship replacement program. In a more recent speech in the House, the Minister stated "our goal is to get for our navy the best equipment possible for the tasks and roles that it will be assigned in the years that lie ahead."

All of us can play our part by ensuring that we maintain and increase our effectiveness in the face of changing conditions. I am convinced that the Navy possesses the inherent capacity to do this, and that the Royal Canadian Navy will continue to be a strong and effective arm of the defence forces of our country.

Plans and studies are continuing for a ship replacement program that will keep the Royal Canadian Navy modern in years to come and which will provide effective forces to meet the foreseen requirements of the 1970s.

The Minister has stated that he hopes the current review of defence policy will be completed early in the New Year and at that time a statement of policy will be presented to the House of Commons.

I am confident that when that announcement is made, the constant loyal and energetic support which you have given over the years will enable me to report that the Navy is ready to proceed.

2. *Acquisition of Oberon Submarines*

The decision of the federal government to buy three Oberon class submarines for the Royal Canadian Navy was announced in the House of Commons on November 5 by the Minister of National Defence in the following words:

WE HAVE DECIDED to proceed with the acquisition of three Oberon submarines for the Royal Canadian Navy.

On April 11, 1962, the then Minister of National Defence announced that the Government had approved the acquisition of three Oberon submarines subject to satisfactory completion of negotiations with the British Government.

The Oberon class is the latest type of conventional submarine to be built for the Royal Navy. The first of the class was commissioned in November 1960, and more of these ships are now under construction for the Royal Navy and the Royal Australian Navy. The requirement for submarines of this kind was set out by the Minister at that time:

"In the training of anti-submarine units constant practice with submarines is necessary to achieve and maintain a high degree of efficiency. The Navy at the present time has one submarine, HMCS *Grilse*, on the West Coast, and in addition on the East Coast there are three submarines on loan from the Royal Navy for training purposes. The three

modern submarines to be procured will make a significant contribution to the training of anti-submarine forces both in the Royal Canadian Navy and the Royal Canadian Air Force. The effectiveness of the submarine itself in the anti-submarine role has been greatly enhanced in recent years by the development of new types of armament and detection equipment. The Oberon class submarine is equipped with modern armament and technical equipment for the anti-submarine role. In addition to the training role the submarines will be a valuable complement to the surface fleet and aircraft in undertaking their anti-submarine defensive task."

The conditions to be negotiated with the British Government included production sharing arrangements which would involve British purchases in Canada and British participation in the development of the CL-89 reconnaissance drone, an unmanned reconnaissance vehicle being developed by Canadair in Montreal. This project, in which the British are sharing half the development cost, is designed to meet the requirements of the Canadian and British armies for a simple, lightweight, low cost reconnaissance vehicle to gather intelligence in forward battle areas. As the implied conditions in re-

spect to the Oberon purchases have now been met, the Canadian Government has decided to proceed with the acquisition.

As indicated by the former Minister, these submarines will be used primarily for training purposes, but are also fully operational as anti-submarine weapons systems and they can be used in anti-submarine "barriers". These submarines will also be available for assignment to NATO in lieu of surface ships. I would like to emphasize that this decision should not be represented as new policy. The primary requirement is to exercise our existing anti-submarine fleet both

air and sea, to enable them to maintain maximum possible effectiveness. It is consistent, therefore, with the announced policy of the Government as expressed in my statement to the special committee on defence on June 27, 1963, "To make effective those weapons systems which have been acquired as part of the Canadian contribution".

As I indicated in the House of Commons a few days ago, we are undertaking a thorough study of our future naval requirements. Once these have been determined, it will be the policy of the government to undertake production in Canadian yards.

3. Cancellation of the GP Frigate

Cancellation of the Royal Canadian Navy's general purpose frigate program was announced in the House of Commons on Thursday, October 24, by Hon. Paul Hellyer, Minister of National Defence. The program was still in the advanced planning stage and no actual orders had been placed for construction or long lead items.

The cancellation will not affect Canada's current NATO commitment, for which the RCN has sufficient ships. Future planning will be guided by the outcome of a government study, now under way, of roles and tasks to be assigned to the Navy.

The following is the text of Mr. Hellyer's announcement to the House:

IN MY PRESENTATION to the Special Committee on Defence, on June 27 last, I stated that current procurement programs were being re-assessed to determine if they would interfere with the exercise of future policy options. Included in the projects under review was the General Purpose Frigate program. This project was approved early last year at an estimated cost of \$264 million. This was only the cost of the ships themselves. A more detailed analysis of the cost of these eight ships, including support equipment for them, has resulted in a current estimate of \$452 million. Even this figure would not likely be final, however, as some of the weapons systems proposed are still in the developmental stage. Certainly this means that some modification would be inevitable.

While the cost of these ships has been a very important consideration, our review has taken into account other aspects.

These ships were designed to provide in one type of ship an anti-submarine capability, an air defence capability for the fleet and the capacity to carry and land a limited number of troops and light equipment. Necessarily in order to design all these capabilities into one

ship, only modestly larger than the latest anti-submarine escort, it has been necessary to limit the capabilities in each field from those that could be achieved by more specialized ships.

As an anti-submarine ship the general purpose frigate would not be as effective as the latest RCN anti-submarine escorts capable of operating and carrying the HSS-2 heavy helicopter. This helicopter can carry both a dunking sonar and a weapons delivery system. The general purpose frigate would carry a light helicopter which would have a weapons delivery capability only.

One of the central and most costly features of the general purpose frigate system is the provision of air protection for the fleet. This capability involves an estimated expenditure of 100 million for the missiles and associated equipments. The rate of technological change in these missile systems is considerable, and the next few years may see improved systems available at less cost measured in relation to effectiveness.

The general purpose frigate would only have a small troop-carrying capacity. If it should be decided that troop-carrying capacity is a requirement of the RCN, it could be provided by more economical and effective means.

The immediate effect of this program in respect of employment in the shipbuilding industry is not great, Mr. Speaker, because the first keel was not scheduled to be laid down until December of next year.

For these reasons, Mr. Speaker, the government has decided not to proceed with the general purpose frigate program.

I would hasten to add, Mr. Speaker, that this does not mean the end of our ship requirements for the Royal Canadian Navy. On the contrary, we are carrying out studies to determine both the roles and tasks which will be assigned to our navy in the future and the most economical way of implementing them. In the anti-submarine warfare field, for example, we are studying the relative effectiveness of all known systems including aircraft, surface ships and submarines. Our review is concurrent with the NATO review authorized at the Ministerial meeting held in Ottawa in May.

In the meantime, we are aware of the necessity of keeping alive the skills which have been developed in our shipbuilding industry. We are considering accelerating the major reconversion program of the Restigouche class ships, after sea trials of operating heavy helicopters from the *Assiniboine*, one of the St. Laurent class, have been satisfactorily completed this winter. In addition, my colleague the Minister of Transport has an announcement of importance to the shipbuilding industry. On our part we will complete our long-range plans as quickly as possible in order that the placing of orders for future requirements will not be subject to undue delay and in order that the Royal Canadian Navy will have the best equipment we can provide to carry out its tasks effectively.



RCN NEWS REVIEW

Marching along together, the senior bands of HMCS Naden and the School of Music take part in the march-past during divisions at Naden on the occasion of the graduation of the first tri-service class of bandmen from the school. (E-73838)

New Ships Come; Old Depart

Important additions to the fleet and the passing of ship names familiar to many Canadians have highlighted activities of the navy afloat so far this fall.

The *St. Laurent*, refitted with variable depth sonar and helicopter flight deck, was commissioned October 4 at Esquimalt, for service in the Atlantic Command. The *Assiniboine*, first of the *St. Laurents* to be so fitted, arrived in Halifax October 26 from the west coast to begin extensive trials with CHSS-2 Sea King helicopters acquired earlier in the year for the RCN anti-submarine warfare arsenal.

The aircraft carrier *Bonaventure* and units of the First Escort Squadron meanwhile were engaged in a series of NATO exercises overseas, including British and Norwegian ports of call.

The *Haida*, most famous of the wartime Canadian Tribals, paid off at Halifax October 11. She will join other destroyers in reserve at Sydney. She was followed on the 30th by the *Sioux*, a veteran, like the *Haida*, of the Second World War and Korean conflict.

On the same day as the *Sioux* retirement, one of the latest destroyer escorts was heading home to Esquimalt the long way. HMCS *Saskatchewan* was leaving British waters and in mid-November will "chop" to the Pacific Command at the Panama Canal. This

Esquimalt-built escort of the Mackenzie class has served since May in the Atlantic Command on a series of exercises terminating overseas October 30.

The *Margaree*, *Skeena* and *Fraser* of the Second Escort Squadron from Esquimalt exercised with a U.S. Navy hunter-killer group culminating in a stop-over at Pearl Harbour, Hawaii. They were joined there later by the mobile repair ship *Cape Breton*.

West Coast frigates were on squadron exercises in home waters and five of their Halifax sister ships returned from Bermuda where they had exercised with HMS *Onslaught*.

Also in the East, three minesweepers of the First Squadron operated in the Gulf of St. Lawrence region until the end of the month. Their West Coast counterparts by that time were aimed for Prince Rupert, B.C., and a northern mine warfare exercise to last most of November.

COMBINED ISSUE

Because of important announcements and decisions affecting the Royal Canadian Navy, the October and November issues of The Crowsnest have been combined into one enlarged issue of the magazine. Regular publication will be resumed with the December Crowsnest.

At Lauzon, Quebec, two new ships joined the fleet. HMCS *Qu'Appelle*, fourth Mackenzie type to be completed, was commissioned September 14. The Navy's first fleet replenishment ship was commissioned HMCS *Provider* on September 28.

Storms Buffet Ships on Exercise

Severe storms in the North Atlantic and successful anti-submarine attacks highlighted HMCS *Bonaventure's* activities in the final week of a series of NATO exercises which ended October 25 at Rosyth, Scotland.

Commodore R. P. Welland, Senior Canadian Officer Afloat (Atlantic), made the following message to RCN ships on completion, "At the end of this NATO exercise that has much tried our patience and endurance with the weather, I want to say a very well done to the ships. The submarines were hunted successfully which means that a great co-operative effort was put forth on the part of all. Everyone can, I am sure, be genuinely proud of their ships' performances on this exercise."

Opposing forces in the NATO exercises also opposed the weather as large and small ships battled winds up to 70 mph with 40-foot waves. During the week two of the most intense cyclonic depressions ever recorded in the North Atlantic were encountered.

The hurricane force winds caused minor damage to some ships and forced the cancellation of phases of the exercise program.

In operations, Tracker anti-submarine aircraft of the *Bonaventure* rated highly, with Lt. James Cantlie, of VS 880 Squadron, as a stand out.

Lt. Cantlie contacted a submarine while on an aerial patrol about 50 miles north of Scotland. Two and a half hours later he again located a submarine visually about 25 miles from the first location. The contacts were subsequently evaluated as being the same submarine. However, during the final 24 hours of the exercise, Lt. Cantlie illuminated another submarine on the surface and subsequently carried out attacks after it submerged. Lt. Cantlie is the only crew commander with two submarines to his credit during the exercise.

Ships of the RCN participating in addition to the *Bonaventure*, were the *Algonquin*, *Cayuga*, *Micmac* and *Saskatchewan*, all destroyer escorts of the First Canadian Escort Squadron.

Assiniboine Joins Atlantic Command

HMCS *Assiniboine*, first of the St. Laurent-class destroyer escorts to be fitted with helicopter landing platform and variable depth sonar arrived in Halifax on October 26 to join the Navy's Atlantic fleet.

The twin-funnelled ship, commanded by Cdr. Walter S. Blandy, berthed in HMC Dockyard after a month-long trip from Esquimalt.

No stranger to Halifax, the *Assiniboine* presented a vastly different appearance from that of four years ago when she left for service on Canada's West Coast. The *Assiniboine* was the second St. Laurent class destroyer escort to join the RCN. Built at Sorel, Quebec, she was commissioned in the summer of 1956 and served in the RCN's Atlantic Command until 1959, when she was transferred to the Pacific Coast.

The *Assiniboine* is the first of seven ships of her class to complete a major conversion designed to vastly improve their antisubmarine capability.

Recommissioned in June 1963 following her conversion, the *Assiniboine* is equipped with facilities for operating a helicopter and with variable depth sonar for submarine detection. The former is a Canadian concept and the VDS was developed in Canada.

The *Assiniboine* will operate from her flight deck the new Sea King anti-submarine helicopter. A 120-knot, all-weather machine, equipped with the latest detection, navigation and weapons systems, the Sea King is capable of searching, locating and destroying the fast modern submarine.

Haida Paid Off On October 11

HMCS *Haida*, one of the most famous of the Royal Canadian Navy's Tribal class destroyer escorts, and to her ship's company still "the fightingest ship in the RCN", paid off into operational reserve on Friday, October 11.

For the brief ceremony the ship's company assembled for prayers by Roman Catholic and Protestant chap-



HMCS *Tecumseh*, Calgary's naval division, has been judged the most efficient division in Canada for the 1962-63 training year and for the first time has won the Naval Reserve Efficiency Trophy. The trophy was presented to Cdr. A. R. Smith, commanding officer, by Captain M. A. Davidson, Chief of Staff to the Commanding Officer Naval Divisions, at ceremonial divisions in October. A special guest was Cd. Off. W. H. Mitchell, who was the first Chief Petty Officer instructor of the Calgary half-company when it was formed in 1923. Mr. Mitchell now 84, still has a keen interest in the Navy and the Navy League. (Michael Burn photo, courtesy Calgary Herald)

Remembrance in a Far-off Land



Commodore R. P. Welland, Senior Canadian Officer Afloat (Atlantic), on October 31 placed a wreath at the War Memorial, Solheim Chapel, Bergen, Norway.

The memorial area contains plaques listing the names of 2,000 citizens of Bergen who were killed in the defence of their country during the Second World War.

The aircraft carrier Bonaventure was in Bergen for a six-day visit following a series of NATO fleet exercises in the North Atlantic.

A 48-man guard from the Bonaventure, under the command of Lt. Robert Hogg, and the ship's 18-man band, led by Lt. Peter Metcalf, took part in the colourful ceremony which was witnessed by local residents.

Mayor A. Michelsen, of Bergen, accompanied Commodore Welland to the Memorial to represent his citizens. Captain R. W. Timbrell, commanding officer of the Bonaventure, and Captain J. E. Korning, Canadian Naval Attaché at Oslo, represented the Royal Canadian Navy.

lains, followed by the playing of "Sunset" by the band of HMCS Stadacona. The White Ensign was lowered, after which "Carry On" was sounded and the ship's company marched off the ship. Only about 40 of her normal complement of 240 officers and men were on board for the paying-off ceremony.

Although none among her last com-

plement served in the ship during the Second World War, one man had been with her for about six years, including a tour of duty in the Korean theatre. He is PO Allan R. MacVittie.

PO MacVittie first served in the Haida following her refit in 1951, and stayed with her for 18 months. He then served another tour of duty in Korean waters

in a sister ship, HMCS Huron. This was followed by duty in the Magnificent and ashore at Stadacona. He returned to the Haida in June 1958 and had been with her ever since.

Second longest on board was PO Roy Papper, who joined in December 1958, followed by CPO Michael F. Nash, who served on board since August 1959.

HMCS PROVIDER

The RCN's First Fleet Replenishment Ship

THE LARGEST SHIP built in Canada for the RCN, HMCS *Provider* was commissioned on the sunny afternoon of Saturday, September 28, at Davie Shipbuilding, Limited, Lauzon, Quebec. The guest of honour was Hon. Paul T. Hellyer, Minister of National Defence.

The *Provider* has a loaded displacement of 22,000 tons and a service speed of 20 knots. She is designed to give the fleet greater mobility by her support of ships at sea with fuel, ammunition and stores.

Her keel was laid at Davie Shipbuilding, Limited, in May of 1961; and she was launched on July 5, 1962. Her sponsor was Mrs. Wright, wife of Rear-Admiral R. A. Wright, RCN (Ret).

Commanding the *Provider* is Captain Thomas Charles Pullen, previously commanding officer of HMCS *Shearwater*, from July 1960 to October 1962, at which time he was appointed to stand by *Provider* during her final stages of construction in Lauzon. Captain J. A. Heenan, RCN (Ret), who commanded the Fairmile mother ship, the first

HMCS *Provider*, during the Second World War, was a guest.

The principal speakers during the colourful commissioning ceremony were introduced by Cdr. E. W. Kimmerly, Principal Naval Overseer, Quebec. They were T. R. McLagan, Chairman of the Board, Davie Shipbuilding Limited; Vice-Admiral H. S. Rayner, Chief of the Naval Staff; Hon. Paul Hellyer, Minister of National Defence, and Commodore S. M. Davis, Director General Ships. Religious portions of the ceremony were conducted by Rev. C. H. MacLean, Chaplain (P), and Rev. J. E. Whelley, Chaplain of the Fleet (RC).

In his address, Mr. Hellyer said:

"The commissioning of a new ship is always a ceremony of considerable importance—it is the climax to which builders and future owners look forward.

"The significance of the sea to the nations of the world is based on certain factors including economics and geography which, while susceptible to gradual changes, are relatively stable.

"Mobility and the comparative economy of sea transport are inherent in sea power, which has been defined as the ability of a nation, or a group of nations, to make the maximum effective use of the seas in war and peace.

"Because no nation of the Western Alliance is completely self-sufficient and because our prosperity depends on maritime trade, the freedom of the seas is essential.

"As a contribution toward maintaining this freedom, Canada has provided a strong and effective anti-submarine force, and it was just two weeks ago that the latest anti-submarine destroyer escort, HMCS *Qu'Appelle*, was commissioned here in Lauzon. To keep the *Qu'Appelle* and the other ships of the Royal Canadian Navy at sea where they can best perform their tasks, there must be satisfactory arrangements for their replenishment with fuel, ammunition and stores, as well as for maintenance and repairs.

"NATO nations are individually responsible for the logistic support of the forces they earmark for the Alliance,

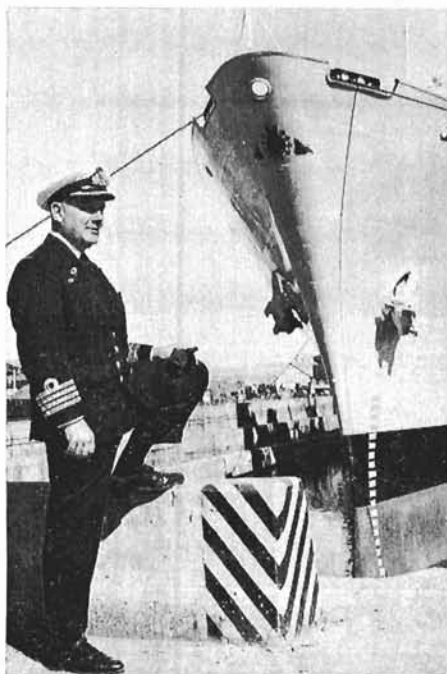

Captain T. S. Pullen with his new ship, HMCS *Provider*. (ML-12836)



Hon. Paul Hellyer, Minister of National Defence, inspects a guard of honour during the commissioning of HMCS *Provider*. The guard officer is Lt. M. A. Smith. (ML-12868)

and the commissioning of HMCS *Provider* today marks the final step in providing the Royal Canadian Navy with a replenishment-at-sea capability of its own, tailor-made for the ships of the Royal Canadian Navy.

"It is perhaps especially appropriate that this ship, HMCS *Provider*, should have been built in a shipyard located on the St. Lawrence River—a river which has played a profound part in the history of our country and provided us with untold benefits.

"To the people of Davie Shipbuilding Limited, who, in times of war and peace over the years, have built more than 630 ships ranging from small powerful tugs to tankers of 40,000 tons, I say:

'Thank you for another job well done. You have demonstrated once again the high standards of technical skills available in Canadian shipyards. This is a proud moment for you.' Today, this ship comes to life—the riveters and electricians depart, and the captain and the sailors take over.

"To the commanding officer, Captain T. C. Pullen, the officers and men who will soon board the *Provider*, I extend my sincere wishes for a successful and happy commission. You have the important task of ensuring that the anti-submarine fleet of the Royal Canadian Navy is never jeopardized by lacking replenishment. The flexibility and mobility of Canada's maritime forces will

depend on your efficiency. I am confident you will do the job well enough although it is a new one to all of you. May I conclude by saying good luck, good sailing, and may you always remember with pride the day the first Fleet Replenishment Ship in the Royal Canadian Navy, HMCS *Provider* commissioned".

With speeches over, the commissioning ceremony began. The Red Ensign was lowered and simultaneously replaced with the White Ensign. Then the officers and men, assembled on the jetty alongside the *Provider*, manned their ship in quick and smart order.

A procession of guests, estimated between 800 and 1,000 strong followed

A Bell Rope for the Provider

The commissioning of the *Provider* in Lauzon on September 28, had an interesting sidelight which, though observed by a mere handful, had a rather nostalgic touch.

On this occasion, the commanding officer, Captain T. C. Pullen was presented with a ship's bell rope by a Davie Shipbuilding Limited employee, Henri Morin.

Mr. Morin has been employed by the shipbuilder for 53 years, starting out at the age of 13 and retiring now at the age of 66. He recalls that when he began working he was paid 50 cents a day for a 12-hour working day. For 36 years he was foreman of riggers in Davie's and until three years ago, when failing health intervened, he maintained this position.

When forced into a less strenuous livelihood, Mr. Morin was attached to the staff of the Principal Naval Overseer, Quebec, on general maintenance and was then allowed to continue on beyond the normal retirement age to see the *Provider* completed.

Mr. Morin has retained his skill in ropework and thus, when commissioning date approached, he commenced the job of voluntarily making an ornamental bell rope for the *Provider*. This was to be his "swan song" as a tradesman in Davie Shipbuilding Limited and he tirelessly devoted a great deal of his own time to completing the project.

The finished product pays tribute to the skill of the craftsman concerned and is a showpiece of this type of work. The gift was gratefully accepted by Captain Pullen at an informal ceremony aboard the ship following commissioning and with the presentation of this small gift, an era drew to an end.

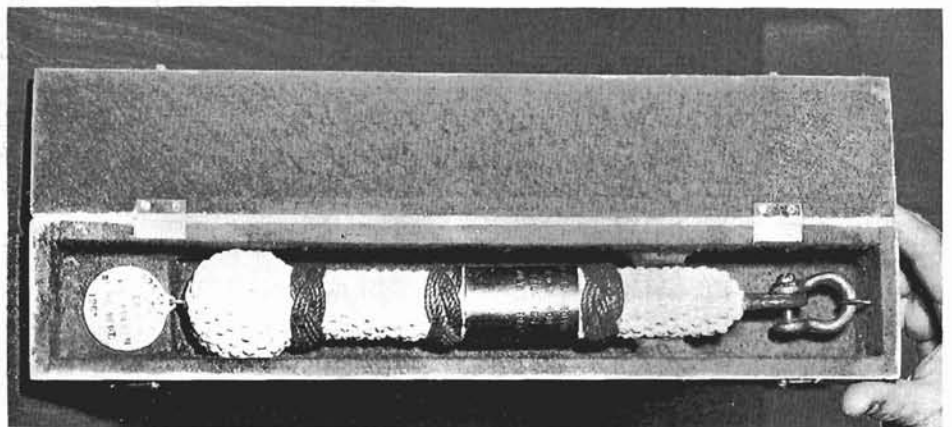



Members of the ship's company of HMCS Provider go on board their ship officially for the first time during the commissioning ceremony on Saturday, September 28, at Davie Shipbuilding Limited, Lauzon, Quebec. (ML-12872)

behind to attend the commissioning ceremony which was held in the ship's helicopter hangar and on the flight deck.

The 551-foot *Provider* has a beam of 76 feet and a loaded draught of 32 feet. She has a service speed of 20 knots, and the vessel's normal complement is 11 officers and 130 men. Her displacement of 22,000 tons is greater than that of the aircraft carrier *Bonaventure* but her dimensions are less.

The *Provider* will not carry defensive or offensive armament. However, she is equipped with sonar, radar and most modern navigational equipment.

She has six replenishment stations and is capable of replenishing two ships abeam at the same time at speeds in excess of 18 knots. She also has facilities for fuelling a ship astern.

She is the second ship to bear the name *Provider*. The first was built at



HMCS Provider has brought with her into the Navy a new ship's badge of original design, classical in its simplicity and in its origin.

The badge depicts an ancient Greek amphora, a two-handled earthenware vessel used as a storage container, some of which have been brought from the sea in recent years still filled with oil or wine—the latter sadly deteriorated by the passage of the centuries.

The amphora of the badge is garnished around the base of the neck with maple leaves and has a fowl anchor on the main body of the vessel, leaves and anchor indicating that the ship belongs to the Royal Canadian Navy.

The golden colour of the amphora represents the yellowish colour of oil, a major item of the Provider's replenishment stores, and the dark background is of navy blue.

Golden yellow and navy blue are also the ship's colours.

Sorel, Quebec, and commissioned in December 1942. Much smaller than her successor, the first *Provider* served as a mother ship for motor launches engaged in anti-submarine and patrol duties. She was declared surplus in 1947 and was sold to commercial interests.





Three Canadian sailors competed against the best of NATO in a communication contest in Rome last summer. The contest held on the initiative of the Italian Navy, was conducted by the European Naval Communication Agency. The RCN competitors were (left to right) Able Seamen Fenwick Gray and Paul E. Fetz, radiomen from Albro Lake Naval Radio Station, and Ldg. Sea. D. T. Davidson, visual signals representative, HMCS Skeena. (DB-18047)

ARRIVEDERCI, ROMA

IN MID-MAY 1963 an interesting document arrived on the desk of the Officer-in-charge, Communication Division, HMCS *Cornwallis*. It was a letter from the European Naval Communications Agency (ENCA) announcing the first of an annual series of competitions to be held among the communications personnel of the NATO navies. This first competition was to be held in Rome July 2 to 6, and Canada was invited to send representatives.

Although there was little time left, it was decided to enter a Canadian team, and three communicators were selected. They were Ldg. Sea. D. T. Davidson, a signalman from HMCS *Skeena*, AB F. E. Fetz, and AB Fenwick Gray, two radiomen from Albro Lake Naval Radio Station. These three arrived in the Communication School in mid-June for two weeks' intensive training, and the necessary inoculations and documentation.

From there, it was by RCAF Transport Command from Greenwood, Nova Scotia, to Trenton, Ontario, and thence to Marville, France. A four-day stop-over in France gave the men a chance to do some sight-seeing in the area. Ldg.

Sea. Davidson a sports car enthusiast, went to Metz to see the Grand Prix, and Able Seaman Gray and Fetz toured Luxembourg. All three left Luxembourg by commercial air on July 1, going via Frankfurt, Germany, to Rome. There they were housed in the Marina Militare, the Italian naval barracks in the heart of the city.

Contestants from the Belgian, West German, Italian, Dutch, Norwegian, British and U.S. navies were already there, and the Canadians were soon made to feel at home. Nearly all the competitors spoke English, although the host Italians had a little trouble with the language. The food was Italian, and quite spicy, a novel change from Canadian naval fare.

The contest ran for four days, from 0800 to 1200 and again from 1600 to 1900 each day. The four-hour break was used for "siesta" or sight-seeing, and the Canadians took every advantage of it. They saw St. Peter's Basilica, the Roman Forum, Trevi Fountain, Castel S. Angelo, the Colosseum, the Olympic Stadium, the "New" Rome and the Victor Emmanuel II monument and numerous other points of interest.

In the contest itself, it was apparent that the late notice of the competition had seriously affected Canadian chances of winning, as the entries from the other countries had been training for a year and were selected from the whole fleet. The Royal Netherlands Navy won the radio reception and transmission and the teletype transmission contests, and the Belgian Navy won the flashing light contest. AB Gray won third place in the teletype contest, a creditable performance in view of the special training received by the other contestants.

On the closing day the awards were presented, and each contestant was given a souvenir scroll. In the afternoon the Canadians started their trip home, spending a night in Pisa, site of the famous Leaning Tower, en route, then by way of Marville, Shannon, Gander and Trenton to their respective ship or establishment.

In the time the men were away they travelled more than 14,000 miles, were in five European countries, met members of seven other NATO navies. Their reports will help in selecting and preparing future teams, so that Canadian competitors will stand a better chance.

OFFICERS AND MEN

Graduation Held For Bandmen

The tri-service School of Music at HMCS *Naden* held its first graduation exercises on September 27 and a highlight of the event was a family matter.

The major award for top marks in the two-year course went to the tallest student, Leading Aircraftman Hugh J. McCullough, whose home is in Ottawa. His marks matched his height—he held an average 96 per cent score throughout the course.

News that he had won the top award in his class of 18 was kept from him until the last minute. So was another pleasant surprise—the fact that the trophy was to be presented to him by his father, Warrant Officer Hugh McCullough, a member of the RCAF Central Band in Ottawa.

The graduation of the tri-service class of military bandmen was held on the parade ground of HMCS *Naden* in conjunction with Friday divisions. The guest of honour, on hand to present certificates and other awards, was Rear-Admiral W. M. Landymore, Flag Officer Pacific Coast.

The *Naden* band and that of the graduating class from the tri-service music school took part in the afternoon program. Under the command of Lt.-Cdr. Stanley Sunderland, the School of Music at *Naden* is the only one of its kind. In it are trained bandmen from all three of Canada's armed forces.

Appointment Extended

Her majesty the Queen has graciously approved the re-appointment of Surg. Captain L. E. Prowse, RCNR, as Queen's

Weddings

Lieutenant Arthur Boutillier, HMCS *Star*, to Joy Mary Duggan, of Armdale, Nova Scotia.

Ordinary Seaman Roy Charles Hughson, of HMCS *Shearwater* (VS-880), to Trudy Charmaine Cruikshank, of Halifax.

Able Seaman Earl R. Demers, HMCS *Fraser*, to Fern M. Peters, of Victoria.

Sub-Lt. P. W. Dumbrille, *Kootenay*, to Carolyn Meadus, of Hacketts Cove, N.S.

Lieutenant W. E. MacKenzie, HMCS *Bytown*, to Dianne Lee Stuart, of Ville La Salle, Que.

Ordinary Seaman Dale R. Roth, HMCS *Fraser*, to Janet Robert, of Red Deer, Alberta.



Highest in standing and tallest physically of the members of the first graduating class of the *Naden* School of Music was Leading Aircraftman Hugh McCullough, to whom the trophy representing the top award was presented by his father, Warrant Officer Hugh McCullough, of the RCAF Central Band, Ottawa. Others in the picture are Lt.-Cdr. Stanley Sunderland, officer in charge of the tri-service school, and Lt.-Cdr. Harry Cuthbert RCN (Ret) first commanding officer of what was formerly the RCN School of Music (E-73841)

Honorary Physician. Each of the Canadian Armed Forces is represented by a medical officer appointed for a two-year term.

Surg. Captain Prowse has been commanding officer of HMCS *Queen Charlotte*, the Charlottetown naval division, for the past two years. In civilian life he is director of anaesthesiology for Prince Edward Island Hospital, Charlottetown.

Adoption for Hong Kong Boy

Naval and civilian members of the Naval Communications Centre in HMC Dockyard, Halifax, have adopted an eight-year-old Chinese boy from Hong Kong under the Foster Parents Plan.

Ho Chung Lam, who with four brothers and sisters lives in a refugee resettlement building in Hong Kong's slums, has written to his foster parents as follows:

"I am very happy to become your foster child. I am grateful to you for your help to attend school. I shall bear

in mind your kindness to me. This is the first time I am writing you a letter and I do not know what to say.

"I am studying in Chaiwan Gov't School in P.1 and I have English, Chinese, Civic, social and arith subjects to learn at school but the subject I like most is English transcription. I like to read and I will study hard in order to make full use of your money and my time. I have many classmates and we play together and read together. So I like to be in my school.

"My father is working in the Sanitary Department and my mother does plastic flowers at home to earn a little. I am the eldest child of my parents; I have 2 sisters and 2 brothers. The older sister

Births

To Chaplain (P) H. I. Hare, HMCS *Naden*, and Mrs. Hare, a daughter.

To Petty Officer George McKenzie, HMCS *Fraser*, and Mrs. McKenzie, a daughter.

To Lieutenant G. L. Maloney, HMCS *Bytown*, and Mrs. Maloney, a son.

To Able Seaman Leroy Sinclair, HMCS *Fraser*, and Mrs. Sinclair, a daughter.

has the opportunity to attend school. The rest live and stay at home.

"I received thru PLAN your Grant HK \$45.00 (US \$8.00) plus HK \$25.00 for new text-books and 2 pairs of white socks. Many thanks for all these.

"It is summer in Hong Kong and it is very hot now. We are now under water restriction and so we find it very inconvenient. I hope it will rain more to solve the problem of water shortage. I want to know something about you and your city. Please give me a reply. Goodbye for now. I shall write you again.

"With best wishes.

"Your Foster child

"HO CHUNG LAM"

Officer Named To Ghana Team

Lt. Frank Winfield Mercer, of St. John's, Newfoundland, has been appointed to the Canadian Armed Forces Training Team in Accra, Ghana.

Born on December 28, 1925, in St. John's, he served in the Royal Naval Volunteer Reserve in 1944-45 and entered the RCN on a short service commission in 1959.

He has served most recently as Naval Career Counsellor, Maritimes, during which time he made his home in Dartmouth, N.S.

RN Submarine Flag Officer Visits

Rear-Admiral H. R. Law, Flag Officer Submarines Royal Navy, was in Halifax in mid-October for a two-day visit to the Atlantic Command. Admiral Law arrived by air at *Shearwater* from Ottawa.

During his stay he visited Maritime Command Headquarters and conferred with Rear-Admiral J. V. Brock, Maritime Commander Atlantic. He also inspected the Royal Navy's Sixth Submarine Division, visited the submarine HMS *Auriga*, toured submarine base facilities and met with officers and men attached to the submarine division.

Admiral Law left for Washington on Saturday, October 12.

RCN Official on Safety Council

Superintendent of Industrial and Safety Engineering for the Royal Canadian Navy, D. I. Darling, of Ottawa, has been elected to serve as a member of the executive committee of the public employee section of the National Safety Council, as regional representative for Canada.

The election was held during the October National Safety Congress, an-

nual convention of the Council, which has its headquarters in Chicago.

The National Safety Council is a non-profit association dedicated to safety in all fields of accident prevention.

191 Begin RCN Officer Training

A university education and a military career are being combined by 185 young men from across Canada who have been enrolled in the Royal Canadian Navy as officer cadets under terms of the Regular Officer Training Plan.

Of these, 91 were accepted for entry into the three Canadian Service Colleges: Royal Roads, near Victoria, B.C., the Royal Military College of Canada, Kingston, Ont., and le College Militaire Royal de Saint-Jean, Que. The remaining 94 will attend universities.

Under this tri-service plan, cadets are educated, at government expense, to university level and, upon graduation, receive, with their degrees, commissions as officers in their respective services.

The program is designed to develop leadership and qualities of character while conducting a concentrated course of academic study to prepare future officers for positions of responsibility.

Six seamen have been promoted to officer cadets and are attending the University of British Columbia and the University of New Brunswick as part of the Navy's College Training Plan.

They are: PO Anthony Holland, Able Seamen Neil A. McKinnon, Kevin M. Morrison, John David Vince, William J. Rooney and Wayne T. Marsh.

The qualifications for CTP are similar to those of the Regular Officer Training Plan but apply specifically to RCN personnel serving on the lower deck who have been selected as officer cadets. While attending university, for which all expenses are paid, the CTP cadets receive the same professional training as their ROTP counterparts.

Following graduation, and having received their university degrees, the cadets will be commissioned sub-lieutenants.

Sea Cadets Join Officer Plans

Quebec boys are becoming increasingly sea-minded, judging by recent enrolment figures of the Royal Canadian Navy's officer training programs.

Quebec leads all other provinces in the ratio of enrolled Royal Canadian Sea Cadets accepted to train as future naval officers. One out of every 127 Quebec sea cadets has been accepted in the Regular Officer Training Plan or Short Service Officer Plan.

British Columbia is second with one candidate for every 142 sea cadets, while the prairie provinces are third with one for every 200. Ontario's enrolment of 3,172 sea cadets yielded 12 successful candidates, or one for every 264 boys enrolled. The Maritime provinces and Newfoundland produced one officer cadet for every 280 boys enrolled in the Royal Canadian Sea Cadet Corps.

Former sea cadets accounted for more than 20 per cent of all naval recruits last year, and provided one quarter of all officer candidates. The movement has become particularly popular in Quebec province where the Navy League of Canada opened six new corps in the past year.

Naden Band Shares In Memorable Event

The *Naden* band and the Victoria Symphony Orchestra joined forces on August 29 to present a concert at Royal Roads in support of the orchestra.

The warm evening and superb setting, together with the quality of the musical program, made the event a memorable one for Victoria.

The program included Tchaikovsky's "1812 Overture", for which *Naden's* field gun crews provided the cannon fire.

Officers to Serve In Viet Nam

Two naval officers were to take up appointments later in November with the military component of the Canadian delegation in Saigon, Viet Nam, for duty with the International Commission for Supervision and Control.

They are Lt.-Cdr. Robert Dewhirst and Lt.-Cdr. William S. D. Hendry. They have been appointed as replacements in the annual rotation of naval officers participating in this international commitment.

Admiral Madden Visits 'Bonnie'

Admiral Sir Charles Madden, Commander-in-Chief of NATO's Eastern Atlantic area, spent two days at sea in the *Bonaventure* during NATO exercises in the stormy North Atlantic during October.

A helicopter from the *Bonaventure* brought Admiral Madden from the Netherlands carrier Karel Doorman. Commodore R. P. Welland, Senior Canadian Officer Afloat (Atlantic) greeted Admiral Madden on arrival.

His transfer to the Canadian carrier was made as heavy seas and wind battered a NATO fleet participating in exercise Flat Rock.



Now and - -



Then

The picture at the lower left was taken on January 28, 1949, as the cruiser Ontario (the ship in the background) and the destroyers Athabaskan and Crescent were about to sail on a spring training cruise that took them to the West Indies to rendezvous with the aircraft carrier Magnificent and destroyer Haida.

Displayed on the cover of the March 1949 issue of The Crowsnest, the picture showed Mrs. Angus saying farewell to PO T. D. Angus (left) and Mrs. Kittson and daughter Heather saying their goodbyes to Ldg. Sea. (Electrician 3C) W. J. Kittson. The two-year-olds in the carriage, Brian Angus (left) and Donald Kittson, weren't quite old enough to grasp what was going on.

The top picture carries us to the present day and we find the two former occupants of the carriage taking a definite interest in what was happening—namely their attestation into the Royal Canadian Naval Reserve at HMCS Malahat, the Victoria naval division. Personnel are reversed in comparison with the other picture and are, left to right, CPO Kittson and son, Donald, and Brian Angus and his father, CPO Angus. The recruiting officer at Malahat is Lt. G. J. Colwill, but the presence of the two chiefs on his staff may have been a factor in the boys joining the RCNR.

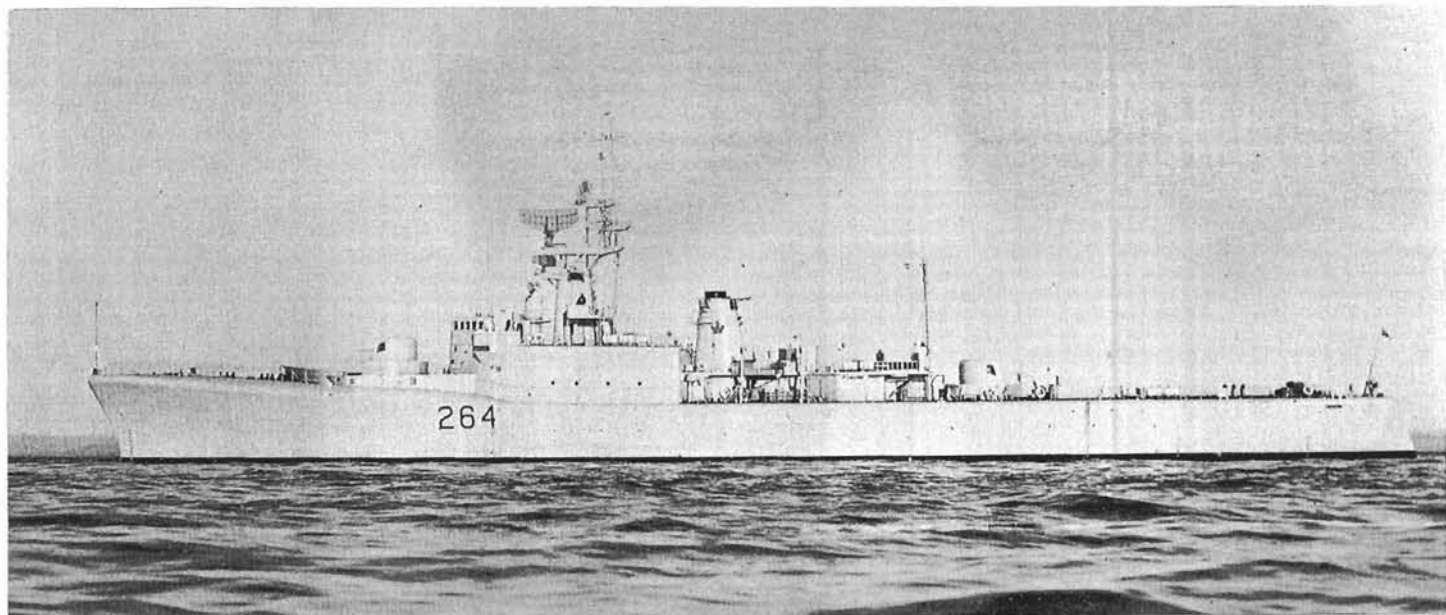

HMCS Qu'Appelle, latest Mackenzie class destroyer escort to join the fleet. (ML-12416)

HMCS QU'APPELLE

HMCS *Qu'Appelle* was commissioned into the Royal Canadian Navy on the afternoon of Saturday, September 14, at Davie Shipbuilding Limited, Lauzon, Quebec. The guest of honour was Hon. Lucien Cardin, Associate Minister of National Defence.

The *Qu'Appelle*, the fourth of six Mackenzie class destroyer escorts to join the fleet, is named after the Qu'Appelle River in southeastern Saskatchewan and is the second ship in the Royal Canadian Navy to bear the name.

Construction of the *Qu'Appelle* began at Davie Shipbuilding, Limited, Lauzon, in January, 1960, and she was launched on May 2, 1962. Her sponsor was Mrs. Diefenbaker, wife of the Rt. Hon. John G. Diefenbaker, then Prime Minister of Canada.

Commanding the new destroyer escort is Cdr. A. G. Kilpatrick, formerly on the staff of the Assistant Chief of Naval Personnel (Plans), in Naval Headquarters.

Rear-Admiral J. B. Caldwell, Chief of Naval Technical Services, Naval Headquarters, formally accepted the ship for the RCN.

Almost 450 invited guests attended the colourful afternoon event. Among them were representatives of all levels of federal and provincial government, industry, business and the armed forces.

The setting for the ceremony was a picturesque one with sunbathed Quebec

City across the river in the background. The freshly painted and scrubbed ship was secured at the end of the DSL outfitting wharf.

Guests started to arrive early and many were leafing through the French-English commissioning booklets as the ship's company, guard of honour and *Stadacona* band formed up on the jetty alongside the new warship.

With the arrival of Mr. Cardin, the ceremonies began. Cdr. Kilpatrick met the associate minister as he disembarked from his car. Lt. G. A. (Tony) Bennett, guard officer for the occasion, then invited Mr. Cardin to inspect the guard of honour.

Cdr. E. W. Kimmerly, Principal Naval Overseer, Quebec, introduced the speakers who were R. Lowery, president,



R. Lowery, president of Davie Shipbuilding Limited, Lauzon, turns over the *Qu'Appelle* to Rear-Admiral J. B. Caldwell, Chief of Technical Services, representing the RCN. The ship's captain, Cdr. A. G. Kilpatrick, is at the left. (ML-12743)

Davie Shipbuilding Limited; Rear-Admiral J. B. Caldwell, Chief of Naval Technical Services, Mr. Cardin, and Cdr. Kilpatrick. Religious portions of the ceremony were conducted by Rev. Harry Ploughman, Chaplain of the Fleet (P) and Rev. J. E. Whelly, Chaplain of the Fleet (RC).

Others on the dais were Rear-Admiral J. V. Brock, Flag Officer Atlantic Coast; Commodore M. J. Jette, Senior Naval Officer, St. Lawrence Area; T. Veliotis, general manager, Davie Shipbuilding Limited; Cdr. J. M. Favreau, naval assistant to Mr. Cardin; Lt. F. A. White, Flag Lieutenant to Admiral Brock and Lt. J. B. Valiquette, Flag Lieutenant to Commodore Jette.

"As we all know, the prime threat at sea today is the submarine," Mr. Cardin said in his address. "During the Second World War, submarine action was aimed mainly at the destruction of ships, and its operation against land targets was restricted to a few instances of shelling secondary targets of limited military importance. Today, the submarine has far greater scope and it is capable of rendering far more devastating destruc-

tion than the submarine crews of the last war ever dreamed.

"We know that in possible future hostilities guided sea-to-ground missiles may be launched from submarines against targets hundreds of miles inland. I mention this because I feel that it is well to remind ourselves that this ship was designed not so much for the purpose of escort duty as were the ships of World War II, but also to hunt out the latest submarines of a potential enemy which may be lurking off our coast . . .

"Guarding against the submarine will be the *Qu'Appelle's* principal task. This will be a difficult job and will require very specialized skills. This ship which we are commissioning today has incorporated in her many of the technological advances in armament and submarine detecting devices which have been developed in recent years by Canadian scientists, naval personnel and by our shipyards.

"The effectiveness of this ship's modern weapons systems and complex array of equipment ultimately depends upon the officers and men who take her to



Cdr. A. G. Kilpatrick, commanding officer of the *Qu'Appelle*, with Hon. Lucien Cardin, Associate Minister of National Defence, guest of honour of the commissioning of the new destroyer escort on September 14. (ML-12740)



Guests and ship's company at the commissioning of the *Qu'Appelle*. (ML-12763)

sea and make her a vital living unit of the Fleet. The ability to use this ship and her equipment makes heavy demands upon personnel, and today's sailors must be skilled operators and technicians, capable of using their heads as well as their hands. I am sure this ability is possessed by the ship's company of HMCS *Qu'Appelle* and I am sure that each and everyone of them will do their utmost to maintain a record of service second to none.

"I wish to take this moment to commend Davie Shipbuilding Limited, both management and employees, upon a job well done. Once again this ship, their latest achievement, demonstrates the high standard of technical skills available in Canada shipyards . . . As an example of its long history of building ships for the Royal Canadian Navy, the *Qu'Appelle* is the 343rd naval ship to be built by 'Davieship'."

Addressing his concluding remarks directly to the captain, officers and men of the *Qu'Appelle*, Mr. Cardin said:

"The commissioning of this new ship is a proud and memorable occasion for you. I wish you all God speed, good fortune, happy sailing and every success in the tasks that lie ahead."

In his speech Cdr. Kilpatrick outlined the immediate future of his ship to his ship's company; a series of trials and workups in the Halifax area; participation in naval exercises and the hope that there would be voyages to foreign ports in the near future. He also extended a special invitation to Mr. Cardin, a former naval officer, to join his ship for a trip to sea.

With the speeches over, the acceptance papers were formally signed. The Red Ensign was lowered and simultaneously replaced with the White Ensign and then following a few quick orders by Lt.-Cdr. Douglas Ross, executive officer, the assembled sailors marched smartly on board and manned their ship officially for the first time.

A heavy stream of guests followed behind for a special tour of the new DDE. The guests of honour were shown

to the captain's day cabin and later all the guests attended a commissioning reception on the quarterdeck of the new warship.

The *Qu'Appelle* has an overall length of 366 feet, a beam of 42 feet and a mean draught of 13.5 feet. Her displacement is 2,900 tons (full load). Her normal complement will be 12 officers and 217 men.

She takes her name from the Qu'Appelle River in the plains of Saskatchewan and is the second ship in the RCN to bear the name. The first *Qu'Appelle* was the former Royal Navy destroyer HMS *Foxhound*, which was transferred to the Royal Canadian Navy in February 1944 and served throughout the remainder of the Second World War in the Battle of the Atlantic and off the coast of Europe.

The new ship has inherited the following battle honours:

Atlantic	—	1944
Normandy	—	1944
Biscay	—	1944

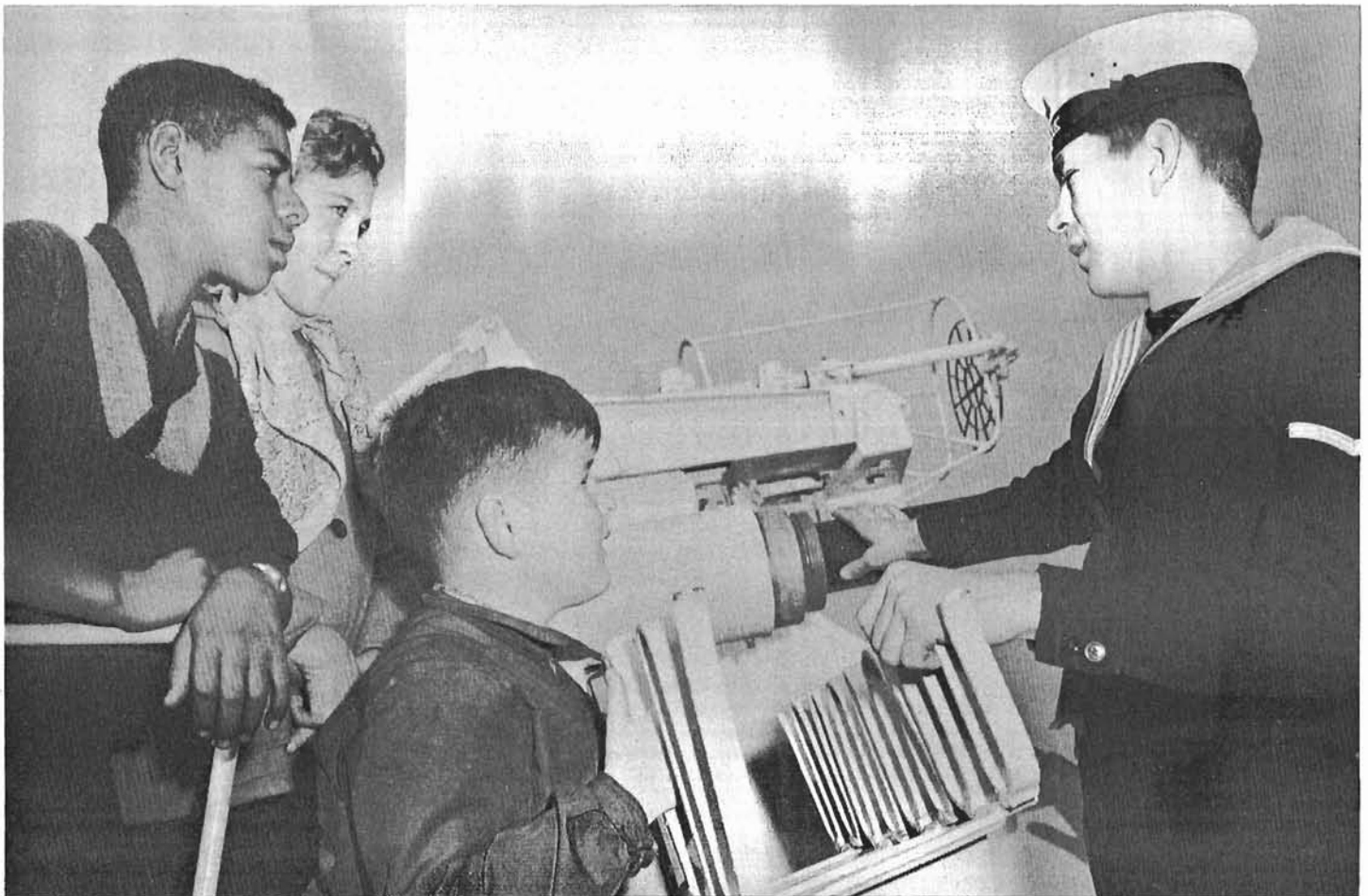

Tommy Clyde, Katherine Cox and Paul Davis, Truro, Nova Scotia students listen intently as AB Donald Sharp explains a 40mm gun on board HMCS Fort Erie. The youngsters were among 115 students, counsellors and supervisors from Truro to tour the frigates Fort Erie and Lanark at HMC Dockyard, Halifax, in late October. (HS-733-16)

AFLOAT AND ASHORE

ATLANTIC COMMAND

HMCS *Sioux*

When HMCS *Sioux* was paid off into operational reserve on Wednesday, October 30, it brought to an end a number of firsts and lasts that this destroyer escort has contributed to the Royal Canadian Navy since she was first commissioned into the RCN in March 1944.

Transferred to the Reserve Fleet following the war, the *Sioux* was converted and modernized to become the first RCN ship to be fitted with bunks in place of conventional hammocks. She was also the prototype for habitability experiments, later incorporated into all new ships.

The *Sioux* and two Tribal Class destroyers the *Cayuga* and *Athabaskan* were the first RCN ships to serve in the Korean theatre. She served three tours of duty there and became the last RCN ship in Korean waters.

She was transferred to the Atlantic Command in 1957 and became a unit of the Third Canadian Escort Squadron. For the past year she had been senior ship of the squadron, under Cdr. C. A. Law.

HMCS *Sioux* also represents the last ship to mount 4.7 inch guns. All other ships are fitted either with 4-inch guns, such as the Tribals, or 3-inch-50 calibre or 3-inch-70 calibre as in the case of the Restigouche and Mackenzie class destroyer escorts.

The *Sioux* returned from her last cruise, a summer in the Great Lakes in support of the Reserve training program, in September flying her 2,500 foot-long paying-off pennant.

Dental Care For *Amphion*

The British submarine *Amphion*, well known to RCN personnel based at Halifax, recently received dental attention at Singapore, according to an item in *Navy Times*.

The *Amphion* sprang a leak in her radar mast and nobody could find a replacement part; Royal Navy dentists were called in, made a part from the material used to make false teeth, fitted it snugly into place over the leak—and the *Amphion* was in business again.



Personnel of the U.S. Coast Guard Ship *Westwind*, summer visitor to Halifax, joined officers and men of the RCN's Fifth Escort Squadron in giving blood at a Red Cross clinic in the Dockyard. Shown are Mrs. Carol Cooke, Boatswain's Mate James Overton, USCG, and Ldg. Sea. Percival Conway, RCN. (HS-7287)



HMCS *Sioux*, which sailed in October to Sydney to pay off into operational reserve, was not only the first ship to support the drive for a new fleet club in Halifax, but she made the largest donation of any destroyer in the fleet. AB Charles Hibbert, on behalf of *Sioux's* ship's company, presented a cheque for \$4,000 toward the fleet club fund to Rear-Admiral Jeffrey V. Brock, Flag Officer Atlantic Coast. Looking on were Commodore R. L. Hennessey, left, Commodore Personnel Atlantic Coast and Cdr. C. A. (Tony) Law, commanding officer of the *Sioux*. (HS-73320)

In mid-October she added another "first" and "largest" to her list. She became the first ship to support the drive for a new Fleet Club in Halifax and made the largest donation of any destroyer escort in the Fleet, a cheque for \$4,000.

In a brief ceremony at the jetty at HMCS *Shearwater* on October 30, the *Sioux* was paid-off. Attending the ceremony were two former commanding officers, Cdr. Law and Cdr. J. D. Lowe. Her last commanding officer was Lt.-Cdr. H. J. Bird.

PACIFIC COMMAND

HMCS *Fraser*

September was a busy month for the *Fraser*. During the early part of the month the ship, along with other units of the Pacific Command took part in a joint Canadian-United States exercise off the West Coast. On return to Esquimalt the ship's company immediately set to work readying the ship for her annual inspection, and there was a great deal to be accomplished in the three working days available before the event. However, all was ready when the Flag Officer Pacific Coast came on board.

To top off the month, the ship's company dance was held at the Victoria Curling Club on Friday, September 27. The credit for an extremely successful evening belongs to the dance committee of CPO Peter Lesoway, Ldg. Sea. L. H. Norgaard, and Ldg. Sea. J. B. Garbet. Entertainment was furnished by Doug Taylor and his troupe while PO J. G. McLellan and Ldg. Sea. Donald Androwski collaborated in providing an excellent catering service.

September saw the departure of PO Raymond J. Peterson for a Trade Group Three course. PO Peterson was the last member of the original ship's company that commissioned the *Fraser* back in June 1957. He joined the ship as an LSRP2 in 1957 and had served continuously there before his draft to *Stadacona*.

Early August saw the end of another summer of ROTP training cruises for the *Fraser*. The return to Esquimalt harbour was eagerly awaited by the ship's company and cadet midshipmen alike. For the ship's company it meant the start of the annual leave and self-maintenance period and for the cadet midshipmen it meant three tough days of examinations followed by a well earned leave period before returning to their universities.



On October 6, first anniversary of her commissioning, HMCS *Mackenzie* was the cake-eatingest ship in the Royal Canadian Navy. Two huge cakes marked the day, the first a work of art, embodying the ship's badge, produced in the galley by the skilled hands of Ldg. Sea. Ercelle Rhodehouse, the second an ornate masterpiece from University of British Columbia UNTD officer cadets, in gratitude for a day-long cruise in the Strait of Georgia. Ord. Sea. Allan Lobbes had the honour of cutting the former cake, while Cdr., A. B. German, the *Mackenzie's* captain, cut the UNTD offering. (E-73905; E-73934)

HMCS *Mackenzie*

October 6, 1963 will always be a special date in the gustatory memory of personnel of the *Mackenzie*. The date was the first anniversary of the ship's commissioning, and to celebrate the occasion the ship's company was treated to two masterpieces of culinary art.

The first was a cake, produced by Ldg. Sea. Ercelle Rhodehouse, measuring more than two feet square and bearing an iced copy of the ship's badge, with "1962-1963" inscribed thereon. Ord. Sea. Allan Lobbes, had the honour of cutting the first slice while Cdr. A. B. German, commanding officer, looked on approvingly.



Crowning a busy summer, the band of HMCS York, the Toronto naval division, has been awarded the Efficiency trophy for RCNR bands. This picture was taken at the beginning of the band's crowded summer season, when the Sunset Ceremony was performed before 5,000 people on Pier Nine, Toronto Harbour, on the occasion of a reception for HMCS Haida. (COND-8482)

The second was a cake produced by the University of British Columbia's Naval Training Division in appreciation of the annual familiarization cruise the *Mackenzie* conducted on their behalf. Cdr. German did the honours this time as members of the ship's company looked on with well registered expectant delight.

The *Mackenzies* certainly have a right to be proud in celebrating their ship's first commissioned year. After successful post-commissioning workups the ship was destined for the West Coast. On her journey to the other side of the continent the ship traversed the warm waters and tropic climes of the Caribbean and Pacific to visit such intriguing ports as San Juan, Culebra and Acapulco. Encountering the *Saskatchewan* along the way before she joined the Atlantic Command, the *Mackenzie* presented her with a gigantic ice pick, a prelude to the Newfoundland patrol.

Since arriving in Esquimalt the ship has become an active and leading component of the West Coast Fleet.

These brief recollections plus a few statistics such as the fact that the ship has ploughed through 29,573 miles of ocean and served 91,858 meals serve to recall a busy year, the culmination of which is symbolized by time-out to gather around the anniversary cake, laud the old year and welcome the new.

NAVAL DIVISIONS

HMCS York

Bandsmen are busy—especially if they hail from HMCS York, the Toronto naval division.

This statement of fact is supported by the heavy schedule followed by the York band last summer, and the awarding of the Efficiency Trophy for RCNR bands to York this year.

The schedule reads like a booking agent's dream: Reception for HMCS Haida in May; Marine Museum, concert and sunset ceremony in June; concert at Centre Island Park, also in June; concert in Allan Gardens in July; concert in Willowdale Park, Kew Gardens, Casa Loma and three more Metro parks in August, as well as six concerts at the Canadian National Exhibition; and participation in the Labour Day parade and the Corps of Commissionairs dinner in September.

And it doesn't end there. The band played at the Trafalgar Ball in October and was to welcome Santa Claus to Toronto in November. These activities were in addition to the ceremonial divisional duties at York.

In recognition of these activities, Cdr. P. J. Wilch, commanding officer of York, paid tribute to the band in a special talk to the ship's company. At the same time he awarded most of them with St.

John Ambulance First Aid certificates—just one more accomplishment for the bandmen this year.

York wrens had a unique mess dinner recently. It was attended by 19 wrens from other divisions and by two of the higher ranking wrens officers in the service: Lt.-Cdr. Fanta Tait and Lt.-Cdr. Constance E. Ogilvy.

Lt.-Cdr. Tait was the guest of honour, and was presented with an engraved silver compact and a scroll bearing the names of the York wrens.

HMCS Scotian

Cdr. Bruce S. C. Oland has been appointed commanding officer of HMCS *Scotian*, the naval division in Halifax. He succeeds the late Captain George A. Brown.

Cdr. Oland attended Kings College School, Windsor, N.S. and later completed his education at Beaumont College, Old Windsor, England. On his return from England in 1936 he joined the firm of Oland and Son, Limited, in Halifax.

He was active in the militia and served in the Army for six years of the war, retiring with the rank of major.

In 1951 he joined the Royal Canadian Naval Reserve and has held various appointments at *Scotian*, as well as serving in HMC Ships *Warrior*, *Swansea*, *Micmac*, *Cornwallis*, *Stadacona*, *Magnificent*, *Haida*, *St. Laurent* and *St. Croix*.

He was promoted in 1961 to the rank of commander and held the appointment of executive officer of *Scotian*.

In civilian life, with the firm of Oland and Son Limited, he is vice-president in charge of production. He is chairman of the Eastern Claims Committee of the Royal Canadian Naval Benevolent Fund, director of the Maritime Museum of Canada, and was the chairman of the Nova Scotia Retarded Children's Association financial campaign last spring. He is also an honorary director of the Canadian Association for Retarded Children.

HMCS Malahat

Cdr. Peter Thomas succeeded Captain John D. Garrard in command of HMCS *Malahat*, the Victoria naval division, at turn-over ceremonies at the division on Oct. 1.

Captain Garrard, who has served as commanding officer since 1958, has been appointed to the Retired List after 25 years' service.

Cdr. Thomas has served as executive officer for the last five years and is succeeded in that appointment by Cdr. W. F. Walker.

As a parting gesture, Captain Garrard donated a Cock-of-the-Walk trophy in his name to VC-922, the reserve naval air squadron administered by *Malahat*.

HMCS Griffon

Cdr. D. H. Botly, commanding officer, HMCS *Griffon*, the Lakehead naval division, turned over command to Cdr. David A. Binmore, on September 23.

Cdr. Botly joined the service 23 years ago as an ordinary seaman. Following training at HMS *Raleigh* and officers' training at HMS *King Alfred*, he was promoted to sub-lieutenant in 1942.

During the war he served in combined operations in England and Egypt and commanded a landing craft on D-day.

He received his discharge in 1945 and entered the RCNR at *Griffon* in 1951, becoming executive officer in 1959 and commanding officer in 1960.

In civilian life Cdr. Botly is on the staff of the Lakehead Teachers College. He joined the RCNVR in 1939 at Halifax and served in the Battle of the Atlantic in HMS *Ausonia*, an armed merchant cruiser, and the corvettes *Lethbridge*, *Sackville* and *Sherbrooke*, being in command of the last-named.

Cdr. Binmore joined the RCNR at *Griffon* in 1959 and was appointed executive officer in 1960.

In civilian life he is secretary-treasurer of Lakehead Freightways and resides in Fort William. He is married to

LEGAL HANGING AGE BEHIND BARROW RIDE

"What is the legal hanging age in Canada?" This question was argued by Ldg. Sea. Robert Dunsmuir and Ldg. Sea. Archie Henderson, both serving in the *Fraser*. During the exchange Ldg. Sea. Dunsmuir said before witnesses that, if he was wrong, he would personally push Ldg. Sea. Henderson from his home to the ship in a wheel barrow. He lost and all too late found that Ldg. Sea. Henderson lived in Belmont Park, some six miles from the ship.

Saturday morning saw Ldg. Sea. Henderson weigh in at 238 pounds, comfortably settle himself on several pillows and be wheeled down the highway by 140-pound Ldg. Sea. Dunsmuir. However, as a sporting gesture, it was agreed that Ldg. Sea. Henderson would push Ldg. Sea. Dunsmuir up all hills. After logging five and a quarter miles, they arrived at the corner of Admiral's and Esquimalt roads, an ideal spot for deciding that honour was satisfied and recuperation called for.

the former Maureen McCartney of Belfast, Ireland, who served with the Women's Royal Naval Service for five and a half years. They have three sons, Michael, Gary and Timothy.

Cdr. Binmore comes from a family associated with the navy for five generations. His father, Lt.-Cdr. Henry Binmore, RN, formerly of Halifax, now retired and living in Fort William, commanded submarines and destroyers during and after the First World War. He was recalled by the RCN in 1939 and subsequently was transferred to the RN for service with the Royal Navy Technical Mission in Washington.

Succeeding Cdr. Binmore as executive officer of *Griffon* is Lt.-Cdr. Herbert Walton, Port Arthur.

SEA CADETS

There are as many Royal Canadian Sea Cadets as there are sailors in all the destroyer escorts in the Royal Canadian Navy. Current enrolment stands at 10,151 sea cadets and 1,084 sea cadet officers equal to roughly half the strength of the Navy.

Nearly a third of all sea cadets and their officers attended summer training courses during 1963. Attendance figures were: HMCS *Acadia*, Sydney, N.S., 2,165; HMCS *Quadra*, Comox, B.C., 1,060; HMCS *Cornwallis*, 199; HMCS *Naden*, 149; HMCS *Shearwater*, 33; and HMCS *Hochelaga*, 9.

An additional 52 sea cadets and sea cadet officers attended two-week courses at the U.S. Naval Station at Great Lakes, Illinois, as part of an exchange plan with the U.S. Navy League.

Most training courses were two weeks in length, but 476 cadets qualified in naval trades courses lasting seven weeks or more.

More than 20 per cent of all new entry seamen entering the RCN are ex-sea cadets, and a slightly higher percentage is found among new officer entries. However, about 85 per cent of Canada's 10,151 sea cadets enter civilian employment in later life, taking with them the advantages of naval training and discipline.

There are 165 Royal Canadian Sea Cadet Corps, sponsored by the Navy League of Canada. The largest corps is in Winnipeg, with 415, but the greatest density by population is in the maritime provinces where there are 98 sea cadets per 10,000 population. In Burgeo, Newfoundland, the sea cadet corps of 24 forms seven per cent of the local population.

Home from the Sea



Kitchener-Waterloo Reunion Hosts

The Kitchener-Waterloo Naval Veterans' Association will be host club for the annual naval veterans' reunion in 1964, it was decided at a meeting of the directors of the Canadian Naval Association in the K-WNVA clubrooms on the week-end of October 19-20.

It was the first occasion on which the directors had met in the beautiful and functional new clubrooms of the Kitchener-Waterloo association. Delegates and their wives were guests at a dance-social on the Saturday evening and business sessions were held the following day under the chairmanship of H. A. Maynard, of Oshawa.

Miss M. Warren, past president of the Hamilton branch of the Ex-Wrens' As-

sociation, attended as an observer, her presence being particularly welcomed because of the CNA's policy of encouraging the eventual amalgamation of all ex-naval personnel into the national organization.

The proposal to seek the addition of the work "Royal" to the association's title was raised but discussion was postponed on the advice of Commodore R. I. Hendy, RCNR (Ret), who suggested the definition of "member" of the association should first be clarified.

Word was received that a veterans' association was being organized in Vancouver and was contemplating membership in the CNA.

A letter from the Royal Naval Association in Britain congratulated the CNA on its rapid growth and extended best wishes for the future.

On the recommendation of the executive, regional areas of the CNA have been defined as follows: Pacific (British Columbia); Prairies (Alberta and Saskatchewan); Central West (Manitoba); Central East (Ontario); and Eastern (Quebec and the Maritimes). Boundaries will not be strictly drawn, however, and it will be possible, for remote clubs to apply for classification in the adjoining region.

Strongly worded protests were heard from delegates with reference to the position assigned to the CNA in the Warrior's Day Parade at the 1963 Canadian National Exhibition. A request is to be made that the "senior service" status of the naval veterans be recognized. The Kitchener-Waterloo NVA is donating a challenge trophy to encourage pride of appearance among competing CNA clubs.

The Oshawa club announced that work had begun on its new clubrooms and that the official opening is planned for the Saturday preceding Battle of the Atlantic Sunday.

The dates chosen for the 1964 annual reunion are May 15, 16, 17 and 18. All inquiries should be addressed to the Kitchener-Waterloo Naval Veterans'

Association, 315 Weber Street, North, Waterloo, Ont. The host association is young and enthusiastic, giving assurance of another successful reunion.

With the growth of the CNA, consideration is being given to the holding of annual regional reunions, with a national reunion and convention every five years. Applications of a number of clubs to sponsor annual reunions were placed on the agenda of the next CNA meeting, November 24, in Brantford, with Brant Naval Veterans' Associations as host.—S.R.P.

THE NAVAL NEWS LETTER

RECENTLY there has come to light a series of files containing a number of copies of *The Naval News Letter*, mimeographed publication put out by Naval Service Headquarters, Ottawa, during the 1920s and '30s. The *News Letter* was usually published monthly, and contained such features as an "Appointments and Promotions" section, an "Items of Interest" section, from both coasts and the RCNVR Companies, special features of naval interest, and a section devoted to reprinting interesting articles from other publications.

Because of the dearth of historical materials on the RCN and the Reserves during the 1920s and '30s, *The Naval News Letter* is of great value. Unfortunately a complete set of the *Letter* has not been found. The Naval Historical Section has a copy of all the numbers for 1924, 1925 and 1926, issues No. 14, 15 and 16 of May, August and October 1928 and unnumbered issues of September and October 1929 and January and March 1930.

Should any *Crowsnest* readers have copies of *The Naval News Letter*, other than those mentioned above, the Naval Historian would be very grateful if they

A LETTER TO EX-MTB OFFICERS

Dear Sir,

Through the use of your columns, may I, on behalf of the MTB Officers' Association, London, England, call to the attention of all Canadian ex-MTB officers the fact that such an association is in existence, and is open to overseas ex- or retired officers of the RCN who have served in motor torpedo boats?

The annual reunion is held every autumn in London, and an extremely handsome club tie is available at a modest sum.

The secretary is D. E. J. Hunt, DSC, RNVR (Ret), 54 Inner Park Road, Wimbledon, Park Side, London SW 19, England.

May I suggest that those not already aware of the association, and who might be interested, communicate directly with Mr. Hunt?

Yours faithfully,

S. O. GREENING,
Lt.-Cdr. RCNR (Ret)

Greening Industries Ltd.,
Hamilton, Ont.

would send them to him. Copies will be made and the originals returned to the owner.

An illustration of the value of *The Naval News Letter* in filling gaps in Canadian naval history is found in the August 1925 issue in which is described an episode not known to have been recorded elsewhere. This was the capture of the rum-runner *Chackawana* by HMCS *Armentieres*. The story as told in the *News Letter*, follows:

The West Coast customs authorities having requested the co-operation of the naval forces to help them in the search for liquor smugglers, the minesweeper *Armentieres* was lent to carry out the necessary patrols and a customs officer embarked.

On July 20, during the evening, reliable information was received that a suspicious vessel was hiding in one of the numerous inlets off the coast. At



10.30 pm, the ship having arrived at the entrance to the arm, the skiff and jolly boat were lowered and left the ship. The

night was extremely dark and the weather misty. At 11.40 pm, the jolly boat returned with a message that the *Chackawana* had been boarded and seized, with a large liquor cargo on board.

The next morning the captured vessel came out under her own power, loaded to a dangerous degree. The name of her port of registry was below the waterline.

The vessel was towed to Esquimalt and there turned over to the customs officials.

A great deal of the credit for this capture is due to Leading Seaman Armstrong and Leading Signalman Bracey, who took the boats in during complete darkness and in uncharted water. Leading Signalman Bracey took charge of the smuggling vessel during the night and brought her out of the inlet the next morning.



The appearance in *The Crow's Nest* more than a year ago of a "family portrait" of the ship's company of HMCS *Miramichi* set James Lang, of Vancouver, to thinking that he had a similar photo of different vintage. Among his souvenirs he found this "family portrait" of another *Miramichi*—the Bangor class minesweeper of the Second World War. The picture was taken at Prince Rupert, B.C., in the spring of 1942, at which time she was commanded by Lt. W. G. Johnstone, RCNR. Mr. Lang is ninth from the left in the back row.

Guz and the Oggies

TWO NEW WORDS have been written into the vocabularies of about 80 Canadian university graduates and undergraduates.

They are:

"Guz."

"Oggie."

Now, to many a thousand Canadian naval men (present AND past), this may not be a shattering statement. But, outside the service, how many know that the RN's Devonport division is known as Guz; or that its personnel are referred to as Oggies?

(Editorial note: Just for further clarification, legend has it that Guz is an abbreviation for guzzle, as Devon

men were believed to be great guzzlers of the cider their country produces. An unlikely story, really, with rum on issue! Oggie is the Devonian's name for a pasty, comparable to a Canadian meat pie but shaped like a half moon.)

The Canadians involved in this report were members of the Old Fort Henry Guard taking part in this year's Royal Tournament in London's Earle's Court.

The Oggies were the Devonport divisions field gun crew, competing at the Tournament (with gun crews from Portsmouth and the Fleet Air Arm) to the cheers of tens of thousands of spectators.

The Canadian Guard and the Devonport gun crew were the show stealers.

A great friendship developed between them.

It came as a delightful surprise to hear the Canadians providing a cheering section for the Guz crew during the tournament with:

"Devonport, Devonport,

"Oggie, Oggie, Oggie."

Fortunately, with the predominantly Old Country audience, the word Oggie was understood. Otherwise, perhaps, our lads might have been mistaken for Red Indians using a tribal cry.

In return, the navy lads formed a cheering section for the Guard, with

"Fort Henry, Fort Henry,

"Fog, Fog, Fog."



At the pinnacle of the experiences of the Old Fort Henry Guard in London early this year was the Guard's inspection by Her Majesty the Queen and His Excellency Sarvepalli Radhakrishnan, President of India, at a special ceremony at the Commonwealth Institute in Kensington. Behind the two heads of state is His Excellency the High Commissioner for Canada, George Drew. The inset is a photograph taken some years ago of the officer in the immediate foreground of the inspection picture. He is Ronald Simmons, of Halifax, who was a member of RCSCC Nelson in Halifax from 1954 to 1958, leaving the corps with the sea cadet rank of chief petty officer. He and 11 other sea cadets made a four-month cruise of European waters in 1957 in HMCS Quebec. The large picture was taken by Lt.-Cdr. E. H. Bartlett, RCNR (Ret), author of the accompanying article.

The accompanying sentimental report from London is by Ernest Bartlett, travel editor of the Toronto Telegram. During the Second World War he served in the RCNVR as a naval information officer, was captured during the invasion of Sicily and spent the rest of the war as a prisoner.

The Fort Henry Guard, of which he writes, is formed of university students from across Canada. In their summer vacations they don uniforms of a British regiment of the line of 1876, act as guides to tens of thousands of tourists visiting the historic fort, and present drill displays of the period they represent.

They were not being weatherwise with the fog, but it was their way of pronouncing the initials "F.H.G."

The tournament lasted almost three weeks (our guard put on 33 sterling performances in that period) and the friendship grew and grew.

The lads, off duty, gravitated to a local pub (they about filled it) and talked of their respective lands and sang their respective songs.

You haven't, by the way, really heard "Alouette" until you have heard it with a West Country accent! Iss fey!!

And the Fort Henry guardsmen learned the West Country Hymn" . . . which many of you will, no doubt, recall. Just to refresh your memories here are a few lines which can be sung in polite company:

*Oh, how happy us will be
When us gets to the West Countree
Where the Oggies grow on trees.
We'll all go back to Oggieland,
to Oggieland,
to Oggieland,
Where they don't know sugar from
tissue paper,
tissue paper,
marmalade
or jam!*

Heaven preserve us from the day when the Armed Services no longer have their songs. They may not be brilliant, but they DO breed camaraderie!

A couple of nights before the tournament was to close, I was invited by a guardsman (bless their young military hearts, some of them had adopted me) to their barracks where they were seal-

ing their friendship with the Oggies in a tangible way.

They had sent to Fort Henry (in Ontario's Kingston) for a bronze model of one of their rampart cannon. On its wooden carriage (of a style of a century ago) was a brass plate engraved "From Fort Henry Guard to Devonport Gun Crew, 1963."

It would have done your sentimental, naval hearts good (as it did mine) to see the expression on the Oggies' faces when they were presented with this trophy.

In addition, each man was presented with a bronze medallion (they are sold as souvenirs at Fort Henry) as friendship-pieces.

They tucked them into their money belts to carry during the closing runs of the gun-crew competition. I like to think that they helped Devonport to win two of the three cups which are annual prizes.

Gun crews, as you all know, don't stay together for ever. The Devonport men will, no doubt, be posted to different ships and will serve (as is the Navy's way) all over the seven seas.

But, in the years to come, I am confident that when two or more of them meet again, the talk will go back to 1963 and "the Canadians".

THAT won't do this nation of ours any harm!

As a matter of fact, the visit of the Fort Henry Guard to London bred more than inter-service friendship.

Earle's Court holds about 17,000 spectators and the 33 performances were attended. I think I am conservative

when I estimate that a quarter of a million persons cheered "the Canadians".

As I wrote in my own paper, I feel we owe a Royal Canadian vote of thanks to the Ontario government which, through the Ontario-St. Lawrence Seaway Commission, is responsible for fort and guard both.

And, paying tribute where tribute is due, a special vote of thanks to Ronald Way, Ontario's director of historic buildings and sites. The historical accuracy of the guard and its drills (19th century) owes everything to him.

There is a footnote to this report:

The Fort Henry Guard flew back to Canada in a chartered TCA jet, together with their two six-pounder guns.

A TCA official superintending the loading of the guns seemed a bit puzzled. Two guns and two limbers should equal eight wheels . . . but nine wheels were being loaded.

One was a written off naval field gun wheel, beautifully polished up.

And, I understand, back in Guz they are preparing a brass plate to go on it when it is given a place of honour in Fort Henry's museum.

This report may appear sentimental . . . but I do not apologize for that fact.

I was so glad to see this great friendship maturing between these Canadian youngsters and the Devonport boys.

You see, back in the days of what we used to call the Great War (now referred to as World War I) I was an Oggie in Guz!

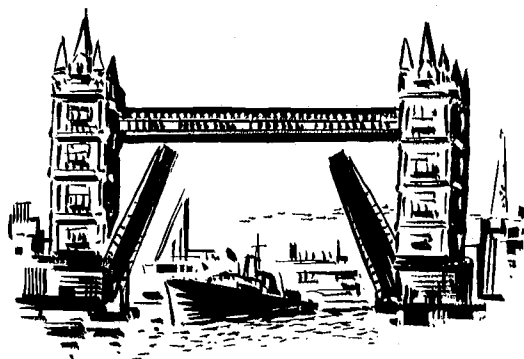

HERE AND THERE IN THE RCN



It was "congratulations and well done" for the ship's company of HMCS Saskatchewan when the ship topped other units of the First Escort Squadron in donations at a Red Cross Blood Clinic at HMC Dockyard, Halifax. To commemorate the occasion a special cake was baked and presented to Ord. Sea. Bill Stoddart (left), and PO Frank O'Neil, crew members of the destroyer escort. Making the presentation is Captain J. P. T. Dawson Commander First Canadian Escort Squadron. (HS-72786)



HMCS St. Croix a few weeks ago was host to 40 boys, dependents of RCAF personnel stationed at RCAF Station Beaverbank, Halifax. The visit included a tour of the ship and was topped off with hot dogs, hamburgers and soft drinks. Sub-Lt. Dent Harrison, one of St. Croix's officers, explains the ship's command position to a group of youngsters. (BK-833-1, RCAF)



Hon. Lucien Cardin, Associate Minister of National Defence, meets submariners on board HMS Auriga during his visit to East Coast naval ships and establishments in early September. (HS-72882)



Lt.-Cdr. (MAD) E. Y. Porter, of Ottawa and Victoria, recently was presented with a certificate making him an honorary member of the Air Force of Chile. The presentation was in recognition of services rendered by Lt.-Cdr. Porter following the disastrous Chilean earthquake in May 1960. An account of his experiences appeared in the December 1960 *Crowsnest*. Photograph shows Lt.-Cdr. Porter receiving the scroll from Rear-Admiral W. M. Landymore, Flag Officer Pacific Coast. Looking on are (left) Surgeon Captain J. W. Rogers, Regional Surgeon, Pacific, and Commodore A. G. Boulton, Commodore RCN Barracks, Esquimalt. (E-73935)



HMCS Haida has retired to operational reserve but she will long be remembered as a ship that wrote some of the most stirring pages in Canadian naval history. She was photographed last summer in Hamilton, Ontario, by Patrick E. Griffiths when she visited his home city in the course of Great Lakes training duties.



Other people may find it a spot of bother to have a ship sink under them—but not a naval photographer. He goes down cheerfully, with camera grinding. This soggy scene was taken by another moist photographer while CPO Norman Keziere was shooting footage for a training film, "The Fatal Mistakes", which deals with equipment discipline. The mock-up of a ship's compartment is in the NBCD School in Halifax.

TRI-SERVICE MEDICAL TRAINING

THE CANADIAN FORCES Medical Service Training Centre at Camp Borden has become the cradle of the medical service for all the Canadian Armed Forces.

Medical personnel from the three services who receive their first training in service medical subjects at Camp Borden include newly enrolled medical officers and nursing officers, who undergo tri-service orientation, medical assistants and wren medical aides, who receive their group one training, and subsidized medical students, who report to the Centre for their first summer training.

Other tri-service courses include the medical officers' course, qualifying surgeon lieutenants for promotion to lieutenant-commander or equivalent, the first aid instructor and first aid supervisor courses for personnel not in the medical branches and the recent commitment of carrying out all hygiene assistant training for the three services.

The unit is truly tri-service in nature and is headed by Group Captain I. H. Barclay, RCAF, who is the commandant and flies his RCAF flag, with four bars denoting his rank, at the masthead.

The RCN is represented by Lt.-Cdr. C. A. Brown, who is chief instructor, and Lt. (N/S) H. Ott, an instructional nurse. In addition CPO E. L. Thomas, a medical assistant, is the senior NCO and regulating chief in the busy Department of Medical Assistant Training which turned out over 400 Trade Group 1 Medical Assistants last year. He is assisted by Ldg. Wren E. A. Kerr, an instructor in the department as well as a supervisor of female students.

The rest of the staff, which totals about 180 officers and other ranks, is made up of personnel of the Canadian Army and RCAF with the former predominating.

Certain aspects of naval life have been transplanted in the unit. Copies of the large ships' badges of the former cruiser HMCS *Quebec* and HMCS *Ontario* are mounted in the officers' mess and a gin pennant is hoisted there on appropriate occasions. In addition, the

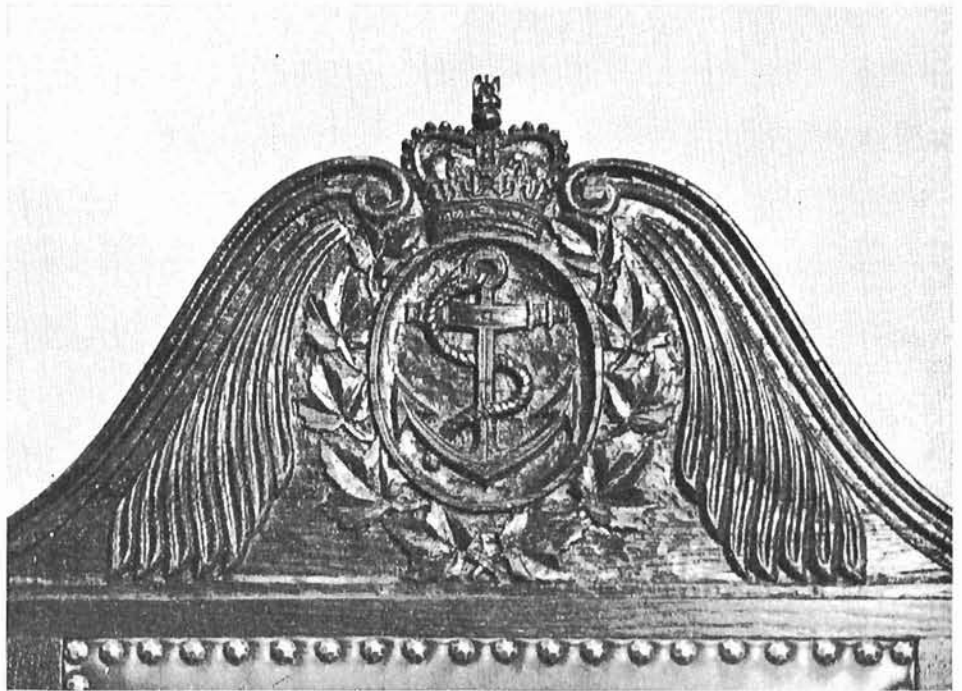

Something after the fashion of King Arthur's Round Table, each of the armed services is represented by its own chair in the mess at the Canadian Forces Medical Service Training Centre, Camp Borden. This shows the fine carved oak back of the Navy's chair.

ship's bell of the former HMCS *Rockcliffe* occupies a prominent place in the trophy case while the grog tub from the *Quebec* is also located in the mess.

Of particular interest to the Navy is the fact that the head table in the mess is equipped with carved, ornamental chairs the head board of each bearing the badges of various Army Corps, with one for the RCAF. There was no chair bearing the RCN badge until the mess recently corrected the omission by arranging for a chair to be carved bearing the RCN badge, beautifully reproduced in oak.

Historical items associated with the medical departments of the three services are suitably displayed in the CFMSTC Museum and the curator would be pleased to receive any donations to augment the small display of naval medical exhibits.

On May 5, 1963, Battle of the Atlantic Sunday was commemorated for the first time in Camp Borden, by kind permission of the camp commander, Brigadier W. J. Moogk. The remembrance ceremony took the usual form of special services in the chapels, with 28 RCN personnel and their wives and families taking part and also supported by a captain from the USN.

The RCN also took part in the Remembrance Day ceremonies on November 11, 1962, with the senior naval officer laying a wreath at the cenotaph of the Royal Canadian Armoured Corps.

It can be seen that, through the kindness and consideration of their brothers in arms, the Canadian Army and the RCAF, the naval members of the community at Camp Borden do not lack in recognition of their customs and traditions.—C.A.B.



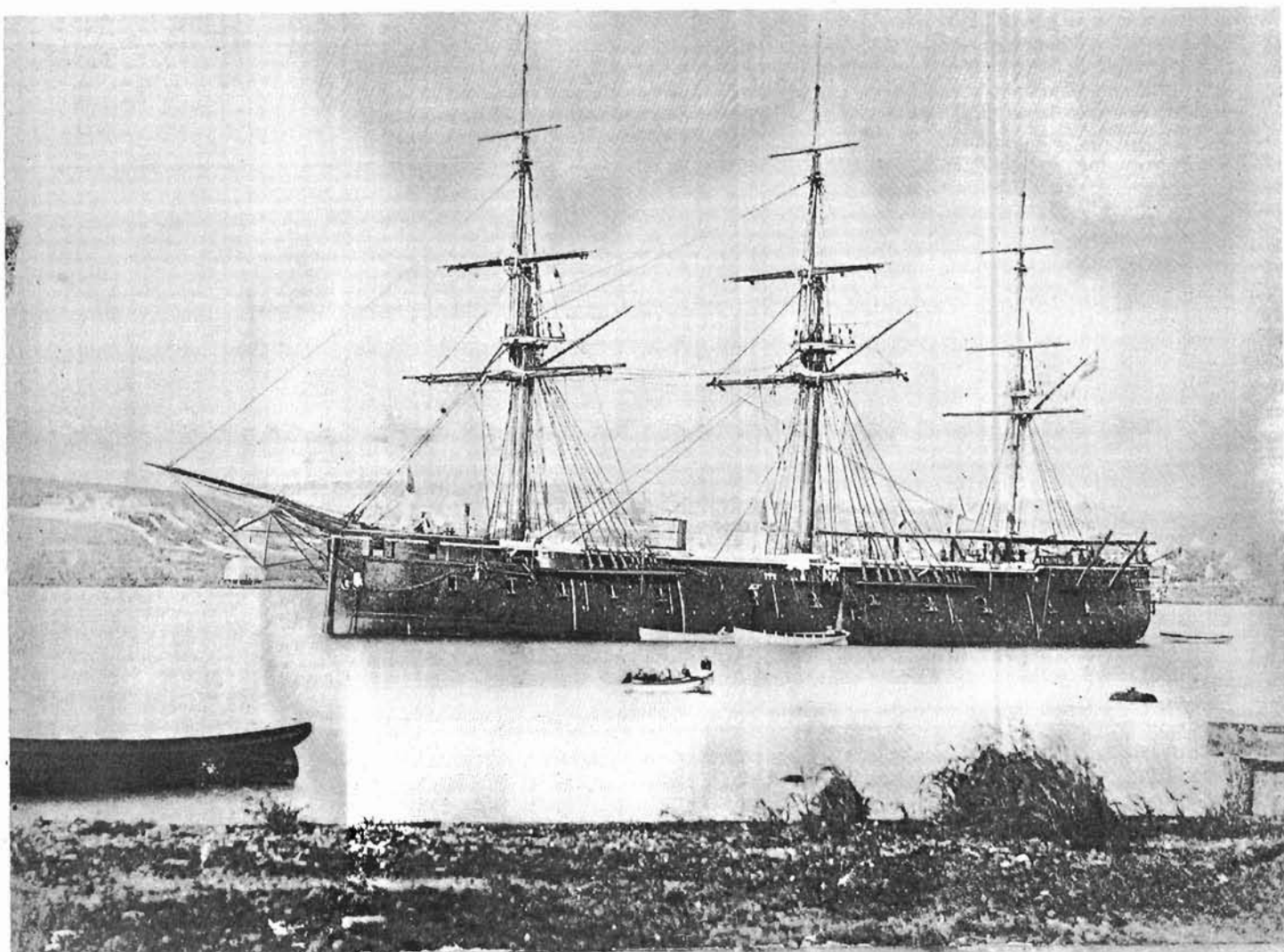

*"Royal Alfred", British armour-plated screw frigate, 18 guns,
2,968 tons, 800 crew, in the Narrows, Halifax Harbour, Nova Scotia.*

HMS Royal Alfred in the Narrows, Halifax Harbour, in 1868. (Photograph courtesy the Maritime Museum of Canada).

FLAGSHIP AT HALIFAX

FLAG OFFICERS at Halifax have not always lived ashore, even though Admiralty House in the grounds of HMCS Stadacona was built for that very purpose. No sooner was that fine residence completed than the Admiralty decided to make HM Dockyard at Bermuda the main base for the ships of the North American Station and, bitterly disappointed, Haligonians saw the dockyard at Halifax all but closed down in 1819. It never really recovered until the brand new RCN took it over in 1910.

But admirals commanding the Station made it a point to visit the northern part of their command during the fine summer months each year and some brought their families north to make use of Admiralty House during the social rounds of the summer season. At such times the flagship lay in Halifax harbour, as was the case in the accompanying photograph. Here, HMS *Royal Alfred* is flying the White Ensign at her mizzen gaff and, at her foremast head, she is wearing the flag of the new Commander-in-Chief, Vice-Ad-

miral Sir George Rodney Mundy, KCB. This was nearly a century ago, in 1868.

Actually, Bermuda was a much better location geographically, not only because of the fine weather which tended to keep the ships and their companies in better shape but also because the command was a very large one. The Station encompassed the western Atlantic all the way from Cape Orange in Brazil to the Arctic Circle.

To carry out his duties in 1868 Vice-Admiral Mundy had some 20 operational ships spread over this vast

expanse of sea, with a Commodore stationed at Jamaica in a sub-command. He even had three regular gun-vessels on the Great Lakes to help ward off Fenian raids from over the southern border.

HMS *Royal Alfred* when she came to North America early in 1867 was quite a new ship and an interesting one in the period of transition from wood to armour-plate. In fact, she was the last timber-keeled ship to be laid down at Portsmouth. She had been designed and begun as a wooden line-of-battle ship to be fully rigged as a sailing ship with additional steam power and she was to have been armed with 91 heavy guns. But after the Crimean War the French grasped the initiative by building, at first, wooden ships plated with iron and, later, iron ships.

With these developments, work was suspended on the *Royal Alfred* until the Admiralty Order of June 5, 1861, directed her completion as an armour-plated ship. Launched late in 1864, it took over two years to fit her out for service. Fully manned and stored, the *Royal Alfred*, when she commissioned for North America, displaced 6,700 tons. From her main deck to 5½ feet below water she was sheathed with six inches of iron plate while her bow and stern were protected by four inches of metal.

She was much shorter than a Pres-tonian class frigate of today, being 273 feet in length. However she drew 24 feet of water forward and 27 feet aft.

Under steam, the ship's single screw was powered by a horizontal reciprocating engine, the piston having a 48-inch stroke in a cylinder 82 inches in diameter. Built by Maudslay, this engine was rated at 800 nominal horsepower, equivalent to 3,230 indicated horsepower. Steam was generated to a pressure of 20 pounds in six rectangular boilers. The *Royal Alfred's* best speed by steam was 12½ knots and it is remarkable that, with her spread of 29,200 square feet of canvas, she many times equalled her steam speed under sail alone.

In proportion to her tonnage she was the most heavily armed ship in the British Fleet. On each side she carried five 9-inch guns each of which weighed 12½ tons. For chasing, she mounted eight 7-inch guns, four being on the main deck, two under the top gallant fore-castle and two on the quarterdeck. To man such a ship required 605 officers and men, a complement that did not include the Admiral's staff.

On her first Atlantic crossing to Halifax she met with almost continuous foul weather and took 25 days for the passage, having only one day's coal at five knots remaining when she made her landfall on Chebucto Head. Being light by the head, she handled well in a seaway but she was a notorious roller, as were most ships of the period.

An examination of the photograph shows that, there being no bridge or pilotage platforms, the *Royal Alfred* was coned from the poop. It will be noticed, too, that the ship's telescopic funnel was located so that the uptakes were protected by the heavy armour-plate.

In the sponsors abreast the foremast were located the "heads" and those vertical lines on the ship's side were called "scupper pipes", which carried water from the deck over the bulge of the ship's side, called the tumble-home. Also, hoisted in the rigging, are seen windsails—funnels or tubes of canvas designed to catch the wind and convey fresh air to the dark mess decks below.

HMS *Royal Alfred* had six years on the North American Station and much of her cruising was done under sail. Paying off in 1874, she spent 11 years in reserve before being sold as obsolete in 1885 for about \$25,000.—E.C.R.

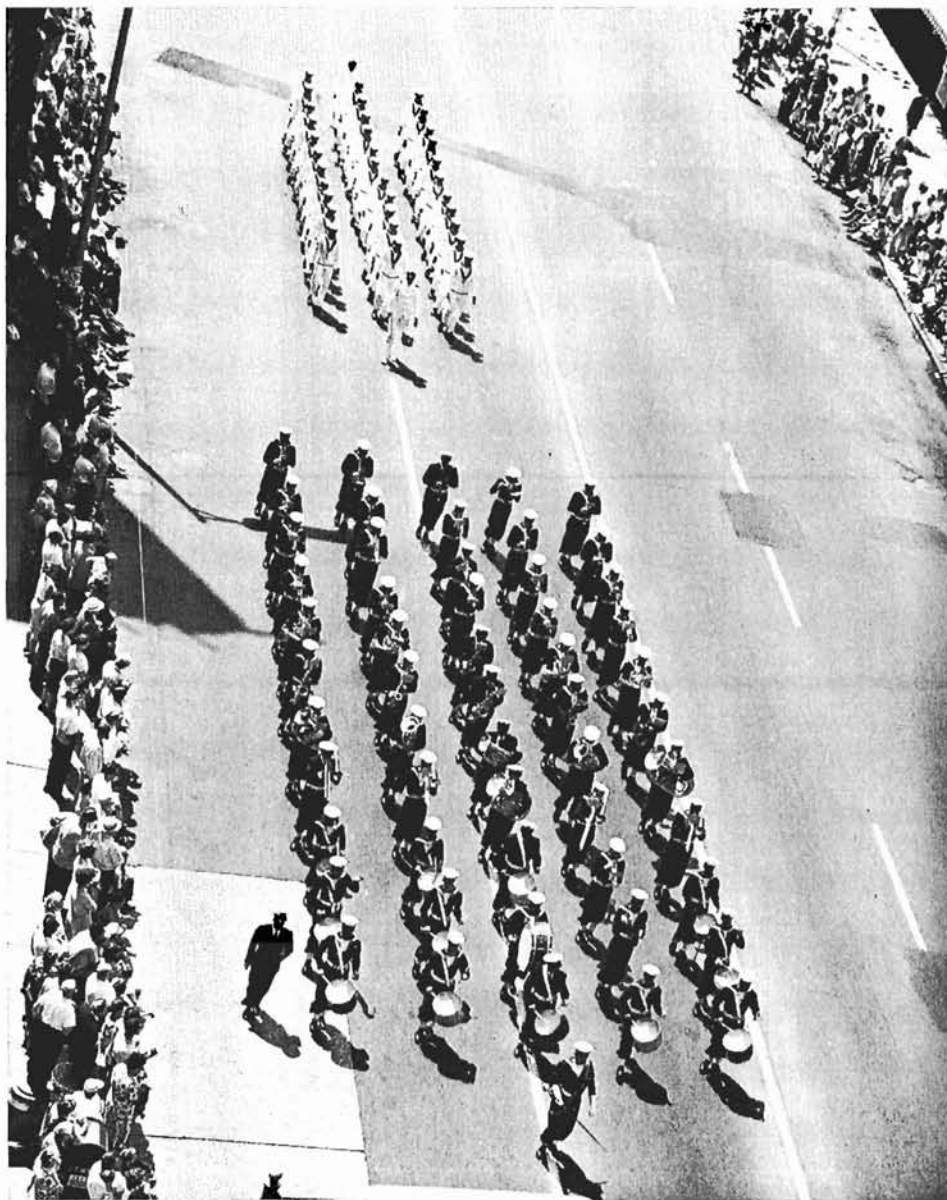

The Royal Canadian Naval Reserve was represented at the sesquicentennial celebrations at Erie, Pennsylvania, this past summer by the Great Lakes Training Centre band from Hamilton. This band made up of bandsmen from 10 naval reserve divisions from across Canada is shown marching in company with part of the ship's company of HMCS Nootka during the parade held to mark the occasion of the founding of the city of Erie in 1813. (COND-8612)

ARCTIC DIVERS 1963

HOW DO YOU get rid of a 50-ton boulder underwater on a beach?

This is only one of many challenges confronting Royal Canadian Navy divers who each year go into the Arctic to clear beaches used for the landing of supplies at various DEW Line sites.

They have a simple and effective way of "removing" such large rocks. Besides the boulder they blast a large hole. A smaller charge is then used to shove the great obstacle into the hole.

Or, if the bottom is almost solid rock and blasting the big hole presents problems, a series of small charges are used to nudge rock out of the way.

Actually blasting to pieces such a large boulder would entail more explosives, and would present the long and tough job of having to move sharp and jagged chunks of rock, according to Lt.-Cdr. Ben Ackerman, officer in charge of the Pacific Command's Operational Diving Unit, located at Esquimalt.

In July, for the fourth consecutive year, a team of RCN divers from Esquimalt went to the barren western portion of Canada's Arctic to clear a number of DEW Line beaches.

They left Esquimalt on July 6 by air for Edmonton, and from there were

Micmacs Board Namesake Ship

The "invasion" ended pleasantly enough but at the first it looked as though the Indians were going to take back Canada, starting with the Navy.

The Tribal class destroyer escort *Micmac* was secured at the Naval Armament Depot jetty, Dartmouth, last July, when word arrived from the main gate that a band of Indians had assembled there and wished to visit the ship.

An officer despatched to the gate found a dozen Micmac Indians in tribal regalia, led by a medicine man garbed in a manner calculated to put evil spirits to flight and almost successful in doing the same for the officer.

Conducted on board the ship, the medicine man informed the captain of the ship, Cdr. J. M. Cutts, that he had been instructed by the tribal chief of the Micmacs to visit and bless the ship. Arrangements were promptly made to permit this, and the ceremony was performed on the forecastle.

Afterwards, the braves and maidens were taken on a tour of the ship and then treated to ice cream and cake.



Naval divers of the Pacific Command again went to the western Canadian Arctic to clear beaches used for landing supplies at various DEW Line sites. Members of this year's team, standing left to right: were: AB Albert Wood, PO Garth Shaw, Ldg. Sea. Albert J. Lodge, and AB Andrew Ouellette; kneeling, PO George Ackerman and Lt.-Cdr. E. D. (Tom) Thompson. (E-72785)

flown to the Arctic. Their places of operation were all desolate, isolated spots. From west to east they travelled from Young Point to Cambridge Bay, a distance of some 1,200 miles of barren Arctic coastline. They worked at eight separate locations and reached each one by air.

The boulders and other debris the divers cleared away are those carried to the shoreline by huge icebergs, then dropped to the bottom with the coming of spring thaws. Some of the boulders are nearly 12 feet in diameter.

They also blasted away, where necessary, remnants of icebergs stranded on

the supply delivery beaches. At times such ice is up to 15 feet thick.

To carry out their task, the explosive-demolition experts employed an estimated 4,000 pounds of explosives.

And there was complaining about summer heat. Water temperatures in that region hover about the 30-degree mark.

In charge of the Arctic beach group this year was Lt.-Cdr. E. D. Thompson, a veteran of 19 years service with the operational diving branch of the RCN.

With him were PO George Ackerman, PO Garth Shaw, Ldg. Sea. Albert J. Lodge, AB Andrew Ouellette and AB Albert Wood.

THE NUCLEAR SUBMARINE TODAY

IN THE PREFACE to *Atomic Submarines* the author, Norman Polmar, writes:

"Man's attempts to navigate beneath the seas have primarily been a struggle to develop a suitable means of propulsion for an underwater vehicle. Such a propulsion system, to be most effective must be capable of operating for long periods of time independent of the earth's atmosphere, must consume fuel at an economical rate, and must be of reasonable size.

"In the 2,400-year search for a suitable submarine propulsion system, the first to meet—and even surpass—all these criteria, is nuclear power. With a nuclear power plant the 'submarine' is, for the first time in history, truly a vehicle that can navigate underwater, and not a surface ship that can submerge for relatively brief periods of time."

It was a pleasure to delve into this book and find a brief and interesting history of submarine development. In addition to displaying his writing talent, the author also shows he is privy to much information generally unknown to service personnel or civilians. The recounting of a number of the behind scenes "clashes" allows the reader to join the protagonists in the joys and frustrations that led to the development of the nuclear-powered submarines. Of particular interest is the information concerning the roles of the early almost-unknown performers, such as Dr. Gunn, Dr. Abelson, Captain Cooley, etc., who later relinquished the stage to the man who was to become the star of the show, Admiral Rickover.

On pages 35 and 36 the author recounts one of the many splendid exploits of Lt. J. S. Launders in HM Submarine *Venturer*. It is too bad Mr. Polmar did not go on to explain how this talented and persevering officer almost single-handedly developed the basic tactics for submerged submarine-versus-submarine attacks. Despite the many gadgets that have been introduced in recent years the original Launders concept still provides the best answer. It is also of interest that Cdr. Launders was appointed recently to a position associated with the Royal Navy's *Polaris* program where, no doubt, his originality and talent can be expected to be of great value.

There are certain errors and omissions. Accounts of the operations of nuclear-powered submarines in the Arctic are of particular interest to Canadians who have so long looked on this area

BOOKS for the SAILOR

as their private domain yet been so timid in their involvement in the area. It is unfortunate that the author, in his endeavour to tell much while not giving away any secrets, might confuse a few readers. On page 114 we journey with the USS *Skate* into the Arctic in August; on page 115 we find our vehicle has arrived at the North Pole on March 11; on page 117 we find we are surfacing on August 14 in an opening in the ice-

pack and, on page 119, completing our first Arctic cruise. The second Arctic cruise starts on March 4 of the following year, as noted on page 120, leading to the conclusion our arrival at the North Pole on March 11 shown on page 115 belongs in this section.

Nevertheless, this is a fine book which not only tells of past submarine developments but indicates the aims of the future. The illustrations and photographs are excellent. For sailor or civilian, young or old, this book provides an interesting insight into a new maritime concept for peace and war. *Contrib.*

ATOMIC SUBMARINES, by Norman Polmar; D. Van Nostrand Company, Inc., 120 Alexander St., Princeton, N.J., 286 pages; illustrated; \$6.95.

NAVY MAVERICK

FOR HALF A CENTURY, from the War of 1812 until the Civil War, the United States Navy was troubled by a painful thorn in its side: a hot-tempered, eccentric and ambitious officer named Uriah Phillips Levy.

Three things about Levy made him particularly objectionable to his envious and less talented fellow officers. First, he held radical theories about abolishing flogging as a means of discipline, and treating seamen like first class citizens of a proud republic; second, Levy was "no gentleman", having entered the Navy as a non-commissioned sailing master after 10 years in the merchant service; and finally—and most unforgivably—Uriah Levy was a Jew.

A rich, Christian shipowner who wanted Levy to become captain of one of his trading vessels tried vainly to persuade Levy to keep clear of the proud naval fraternity.

"Nine out of 10 of your superiors may not care a fig that you are a Jew, but the tenth may make your life a hell," warned John Coulter.

Levy replied characteristically: "There will be other Hebrews in times to come of whom America will have need. By serving myself, I will help give them a chance to serve."

And serve he did. His early adventures amid pirates, shipwreck, British press gangs, and sea fights of the stirring 1812 campaign are in the best Horatio Hornblower tradition.

His tenacious courage helped him survive 18 months in Dartmoor a prisoner-of-war when his raiding brig was finally captured after taking 29 prizes beneath the cliffs of England.

But his real ordeal began in the stagnant years of peace that followed the 1812 sea war. Levy fought successfully in several duels. He was court-martialed no less than six times and faced a board of inquiry twice. Twice he was dismissed from the Navy—and both times was reinstated by presidential decree. Throughout it all Levy's dedication to the Navy did not falter. He proudly refused a captain's post in the Brazilian Navy while still a neglected lieutenant, saying: "I would rather serve as a cabin boy in the American Navy than as a captain in any other service in the world".

Repeatedly he was placed on "indefinite leave of absence" without pay. Fortunately, he dabbled in Manhattan real estate during a period of wild expansion, and became one of the wealthiest men of his day. He also visited European countries at his own expense to study



new naval tactics of gunnery and steam engines, and lobbied with influential men in politics and journalism to abolish flogging in the U.S. fleet. And repeatedly he returned to active service, rising eventually to become commodore in charge of the American squadron in the Mediterranean. At the age of 62 he died on active service, as a member of a court martial board whose rules he knew so well.

Donovan Fitzpatrick and Saul Saphire have written an entertaining and informative account of this irrepressible crusader, patriot and philanthropist.

They might have gone on to point out that Levy's battle against anti-semitism must have helped the career of another Hebrew seaman a century later—Admiral Rickover, whose nuclear submarines were to give America undisputed priority among naval powers. And Levy would not have been much surprised to learn that Rickover's fiercest opponents were the traditionalists and reactionaries of his own service who still may be heard lamenting their lost battleships and carriers which were crowded out by "Rickover's Navy."—K.E.G.

NAVY MAVERICK: Uriah Phillips Levy, by Donovan Fitzpatrick and Saul Saphire, published by Doubleday Publishers, Toronto; \$5.00.

TWO-OCEAN WAR

INTO ONE BOOK, 611 pages in length, Samuel Eliot Morison has compressed the 15 volumes of his monumental *History of United States Naval Operations in World War II*.

The Two-Ocean War is not, however, a condensation, à la *Reader's Digest*. Rather, Professor Morison has selected the most important battles and campaigns in which the U.S. Navy fought, and these he presents in bold relief against the over-all backdrop of the war.

Ask any historian, or newspaper reporter, and he will tell you it is much more difficult to write a concise account than a lengthy one. It must have been agonizing, then, for Professor Morison to reject so much of the material he so painstakingly acquired and lovingly composed for his official history. He must have realized, too, that there would be criticism, by Americans who were overlooked, and in Allied countries, whose forces receive relatively

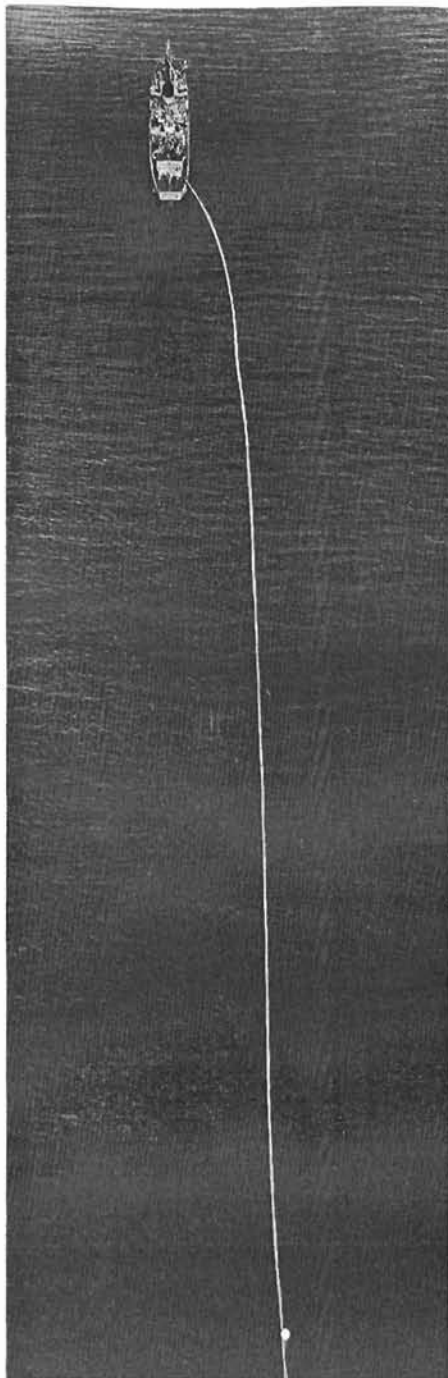

Just a portion of the 2,500-foot paying-off pennant flown by HMCS Sioux when she returned to Halifax in September from Great Lakes training duties. (DNS-32208)

little mention. But he had to be ruthless. Otherwise he would have been off on another voluminous history, and that was not the object of the exercise.

The book is about the U.S. Navy and obviously has been written for popular consumption in the U.S.A. Professor Morison has not, however, aimed it at the lowest common denominator. In it is much the same blend

of scholar-historian-naval enthusiast as in his official history. His style in places is freer, he is more effusive in his praise, and he does not hesitate to comment and express his views. As inevitably happens in a condensation where specifics have to give way to generalities, there are some minor inaccuracies. But Professor (or Rear-Admiral) Morison has done a masterful job.

The book is a tremendous tribute to a tremendous fighting force.

Professor Morison is not, however, among those who contend that the atomic bomb was unnecessary, that by the summer of 1945 the naval offensive and blockade and the devastating raids by the USAF B-29s had brought Japan to the point of surrender.

"The war would have gone on," he says, "and God knows for how long, if the bomb had not been dropped... I do not think anyone acquainted with the admirable discipline and tenacity of the Japanese people can believe (that blockade and conventional bombing alone would have brought a quick capitulation). If the Emperor had told them to fight to the last man, they would have fought to the last man, suffering far, far greater losses and injuries than those inflicted by the atomic bombs." Japan, he says, would have had to be invaded and the cost to the invading forces would have been enormous.—R.C.H.

THE TWO-OCEAN WAR: A short history of the United States Navy in the Second World War by Samuel Eliot Morison; Little Brown and Company, Boston and Toronto, 1963; 611 pages, 52 charts, 25 pages of photos; \$15.

FOR THOSE IN PERIL

DURING NEARLY a century and a half of service in the British Isles, Ireland and the Channel Islands, the Royal National Lifeboat Institution has saved almost 85,000 lives, usually from marine disasters. Its sturdy little lifeboats today are in six main classes, all of painstaking design and construction. Its annual budget is upwards of a million pounds. Its crews are volunteers with scant exception. Family service through several generations is quite common. And it doesn't cost the government a farthing.

Michael Elder was collecting material for BBC scripts but was drawn, inexorably it seems, into writing this 135-

page, illustrated book which treats of the Institution's evolution and some of its more compelling rescues. He has a bibliography on the subject but it is surprisingly slender, considering the tenacity, sacrifice, enormous odds and outright nobility of the life-boatmen who go forth time after time to rescue their fellow man from certain death, often within sight of shore, on the abounding reefs and sand bars about the British Isles.

There is something very moving to picture in the mind's eye the tiny, 35½-footer *Edgar, George, Orlando and Eva Child*, with a name to out-Pogo Pogo, proceeding to the rescue, in this instance, of holidaying cave explorers on the coast who had encountered near disaster. All turns out well, thanks to the *E.G.O. and E.C.*

These subjects deserve the attention of those who write for young people. Such an author will find a well deep with deeds both brave and good from which to draw inspiration for his impressionable readers.—H.C.W.

FOR THOSE IN PERIL, the story of the Lifeboat Service, by Michael Elder; published by Macmillan of Canada; 135 pages, with illustrations and a map; \$4.

WORST ENEMY

THANKS TO Hollywood, the memory of "Bligh of the Bounty" is always kept green, but few remember an even more famous seaman, who sailed, as a midshipman, with the irascible captain on his second voyage to collect the breadfruit tree from Tahiti.

In a recent biography an Australian author traces the career of Captain Matthew Flinders, RN, the cartographer and navigator, 1774-1814. Flinders seems to have been one of those unfortunate people upon whom the gods first smile but whom they afterwards utterly destroy.

By 1803 he had circumnavigated the relatively unknown continent of New Holland (later Australia) and was on his way home to receive the acclaim of a grateful government. Unfortunately, he had to put into Ile de France (Mauritius), where he was immediately interned by a suspicious French government. In spite of strenuous efforts to obtain his release, Flinders languished on the island for seven years until finally repatriated to England, broken in health and spirit.

INTERESTING FARE IN AIR FORCE JOURNAL

Much to interest seagoing personnel can be found in the 1963 edition of *Air Force College Journal*, which was available in November.

Some of the contents are: "Permanent Factors in American Foreign Policy", by Melvin Conant; "Canada and the Pacific", by John Holmes; "Submarine Environment", by Dr. G. R. Lindsay; "South America", by John D. Harbon, retired RCNR officer; "Science and Government", by Dr. A. H. Zimmerman, of the Defence Research Board, and "NATO after the Ottawa Meeting", by John Gellner.

Other articles, reviews of worthwhile books and the best of the essays submitted in the 1963 essay contest will also be found in the *Journal*.

Copies may be obtained at \$1 each from The Editor, *Air Force College Journal*, Armour Heights, Toronto 12.

Before his death in 1814 he managed to complete the writing of *A Voyage to Terra Australis* but he did not survive long enough to see the first published copy.

The author of *My Own Destroyer*, in examining the life of the explorer, comes to the conclusion that a personality flaw in Flinders was responsible for most of his troubles. The case is well presented and the verdict probably correct. Sidney Baker's book is a scholarly, factual addition to the few available works on a remarkable 18th century naval officer.—J.W.F.K.

MY OWN DESTROYER, a biography of Captain Matthew Flinders, RN, by Sidney J. Baker; published in Canada by the Ryerson Press, 299 Queen St. West, Toronto 2B; 146 pages; illustrated and indexed; \$4.75.

ADVICE TO FLYERS

TOO OFTEN, it seemed, the fledgling naval aviator, had to go to many sources and pick the brains of old hands, when and if they were feel-expansive, to get to know his way around outside a cockpit. So the author took five years to compile and write in one volume much of what is required, including the *savoir faire* of the naval aviator.

The Naval Aviator's Guide is a liberally illustrated book, whose shiny pages will need to withstand much wear

and tear, for they are bound to be well thumbed. The contents are in 12 chapters, starting with "Naval Aviation and Its Future" (encouraging), going on through history and tradition, leadership, operational matters, aviation safety, naval aviation squadrons, ship-board life, naval air organization, aviation supply, aviation medicine, aviation career information and a good briefing for squadron duty officers.

The foreword is by Vice-Admiral W. A. Schoech who, as they say on the Avenue, is very big at the Pentagon in naval air matters as Deputy Chief of Naval Operations (Air). He recommends it "to all naval airmen, past, present and future".

In the Royal Canadian Navy, many of our birds have come from various nests—wartime and peacetime RCAF, RN Fleet Air Arm, RAF and the USN pipeline, to which are added our own naval touches. Regardless, any officer or man worth his salt as a professional would do well to read this guide. After all, the U.S. Navy is the largest in the world and the book tells us that "approximately one half of the United States Navy is naval aviation, whether the yardstick be in operations, forces or funds". One cannot ignore such a force and it is a pleasure to have this new book which sets it down so well.

However the wording of the "Navy Flyer's Creed", in the eye of the reviewer, is not wholly inspiring and he was sorely tempted to add another line: "Colour me True-Blue".—H.C.W.

THE NAVAL AVIATOR'S GUIDE, by Captain Malcolm W. Cagle, USN; published by the United States Naval Institute; 310 pages, 60 photographs, 13 drawings by Robert Osborn; price \$5.50.

Two Awards Won By *Ste. Therese*

Two members of the ship's company of HMCS *Ste. Therese*, have received cash awards from the Suggestion Award Board of the Public Service of Canada and letters of congratulations.

Sub-Lt. Roger Michael Bernard and PO David Reginald Brooks, of the ship's sonar department, split the award for their suggestion concerning a modification to a sonar set which has since been adopted for use in the Royal Canadian Navy.

PO Brooks entered the RCN as an ordinary seaman in May 1946. In 1950, he was awarded the King's Commendation for Brave Conduct, in recognition of his part in the rescue of a drowning woman from the Saskatchewan River.

PERFORATED WHARF SUBDUES WAVES

Completion of the world's first perforated caisson breakwater and wharf at Baie Comeau, Que., has now been followed by its successful operation under storm conditions, according to a Department of Public Works press release.

Built by the Department at a cost of close to \$2 million, this unique structure has weathered storms and heavy wave attacks to such a degree that engineers in Canada and other countries are observing it with keen interest. The wharf was under observation during a heavy storm which occurred during the past summer.

The existing pierhead, which is built along traditional lines, protects the newsprint loading berth at Baie Comeau, and it was overtopped by heavy seas at the time, resulting in the overturning of a railway freight car and the derailment of a box car as well as causing general disorder on the wharf deck.

The new perforated structure at that time was built to the same elevation as the existing wharf, 25 feet above low water where the tide range is approximately 16 feet. Construction equipment, lumber piles and material on its deck remained intact during the storm. Due to the unique design, there was no overtopping of the new wharf by the waves.

The new wharf, designed by the Department of Public Works and the National Research Council, is on the north shore of the lower St. Lawrence River about 250 miles northeast of Quebec City, and it brings a puzzling reaction to those who have seen it. It is little wonder, because the idea of building a breakwater honeycombed with holes does not fit in with the ordinary conception of massive concrete and rock structures required to withstand the waves which occur during storms.

In order to overcome the heavy wave action, which would break over a normal pier and make it useless as a berthing space, the Department and the NRC incorporated a new idea to dissipate wave energy. This was accomplished by a perforated wall on the outer side of the structure which allows the waves to pour through the openings into a chamber where their energy is reduced by friction and turbulence. Water spilling back out of the holes creates a counter wave which meets the next oncoming wave and reduces its force. Thus the constant filling and emptying of the chamber reduces the

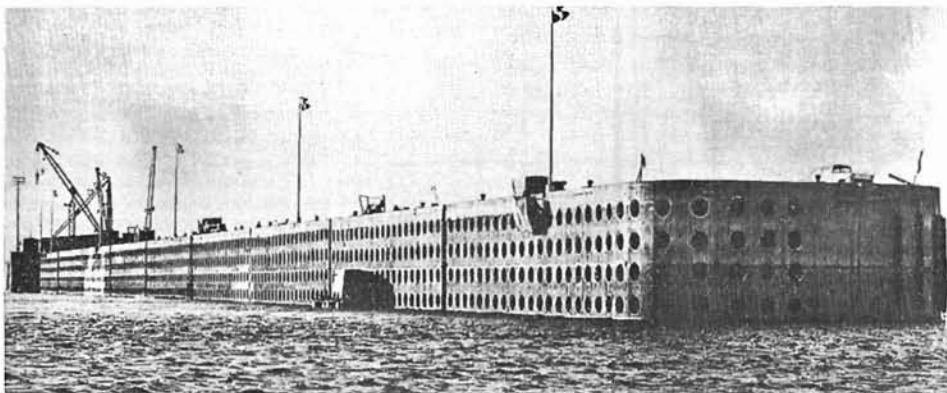

A perforated caisson breakwater-wharf—the world's first—is in operation at Baie Comeau, Quebec. The breakwater is honeycombed with holes through which large waves pour into a chamber where their energy is dissipated by friction and turbulence, and the force of succeeding waves is broken by outrushing water. The top picture is an offshore view of the wharf. In the middle picture a caisson is being towed into position. The bottom picture shows water from spent waves pouring back into the St. Lawrence River, which is about 35 miles wide at that point. (Department of Public Works photos)

wave action and in so doing creates a quiet harbour for ships berthed on the opposite side of the structure.

On a solid faced breakwater, wave action results in a vertical run up almost twice the wave height. It has been estimated that the perforated wall reduces this run up by as much as 80 per cent. It also eliminates overtopping

sufficiently to permit cargo handling on the deck of the structure in all but the most severe storms.

A patent on the design of the structure is held by the Canadian Patents and Development Limited, a subsidiary of the NRC which handles patent licensing and the use of government inventions.

RETIREMENTS

CPO VINCENT JAMES BARTRAM; C1ER4; served June 8, 1938 to January 8, 1946; re-entered May 15, 1946; served in *Naden, St. Laurent, Stadacona, Camrose, Caraqueet, Nonsuch, Blairmore, Peregrine, Sea Cliff, Shelburne, Givenchy, Athabaskan, Ontario, Stettler, New Glasgow*; awarded LS and GC Medal; retired October 11, 1963.

CPO ALEXANDER GEORGE CASTLE; C1RS4; October 3, 1938; served in *Naden, Restigouche, NSHQ W/T Station, Stadacona, Skeena, St. Hyacinthe, Venture, The Pas, Bytown, Avalon, Atholl, Bytown, Scotian, Churchill, Aklavik, Naval Radio Station, Inuvik, Discovery, Coverdale, Cornwallis, Gloucester, Chimo Naval Radio Station*; awarded LS and GC Medal; retired October 2, 1963.

CPO ELMER JOHN DODDS, CD; C2WS3, October 3, 1938; served in *Naden, Fraser, Stadacona, Marie Therese, Venture (Harbour Craft), Skeena, Barrie, Port Arthur, Annapolis, Niobe, RNB Chatham, Huron, HMS Excellent, Crusader, Ontario, Malahat, Royal Roads, Peregrine, Saskatchewan, Cornwallis, Uganda*; retired October 2, 1963.

CPO HENRY GROSSMAN; C1ER4; served in *Naden, Ottawa, Stadacona, Prince Henry, Renard, Annapolis, Niagara, HMS Arethusa, Niobe, HMS Kent, Peregrine, Scotian, Cornwallis, Givenchy, Uganda, Rockcliffe, Athabaskan, Ontario, Nonsuch, Ottawa, Sussexvale, Shelburne, St. Boniface*; awarded LS and GC Medal; retired October 2, 1963.

CPO JOSEPH MYLES GRADY, CD; C2CK3; served in RCNR November 1, 1939 to October 15, 1945; joined RCN May 31, 1946; served in *Stadacona, Fraser, Scatari, Cornwallis, Sault Ste. Marie, Peregrine, Naden, Uganda, Haligonian, Micmac, Scotian, Nootka, Iroquois, La Hullose, Haida, Shearwater, Toronto, Labrador, Sioux*; retired October 14, 1963.

CPO LIONEL STANLEY JAMES, CD; C2CK3; joined February 29, 1940; served in *Naden, Stadacona, Acadia, HMS Emerald, HMS Dominion, Saguenay, Cornwallis, Niobe, Chaudiere, Uganda, Givenchy, Rockcliffe, Ontario, Shearwater, Magnificent, Ottawa, Kootenay, Donnacona, Hochelaga*; retired October 21, 1963.

CPO ERIC AMBROSE LAWRENCE, CD; C1WR4; served in RCNVR September 10, 1940; joined RCN October 6, 1941; served in *Stadacona, Saskatchewan, Cornwallis, Peregrine, Magnificent, Shearwater, Naden, Niobe*; retired October 5, 1963.

CPO BRUCE HUGH MANCOR; C2BN4; joined October 3, 1938; served in *Naden, Ottawa, HMS Dominion, Assiniboine, Stadacona, Clayoquot, Stadacona, Woodstock, Athabaskan, Sheerness, Niobe, HMS Excellent, RNC Stamshaw, Algonquin, Crescent, Cornwallis, Ontario, Stettler, Unicorn, Margaree, Peregrine, Stormont, HMS Trumpeter, Warrior*; awarded LS and GC Medal; retired October 2, 1963.

CPO GEORGE ARTHUR McCUE; C1SG4; joined October 3, 1938; served in *Naden, Restigouche, Stadacona, St. Croix, Shawinigan, St. Hyacinthe, Niobe, Haida, Nootka,*

Micmac, Magnificent, Quebec, Bonaventure, Assiniboine, Ottawa, Cornwallis, Cape Scott; awarded LS and GC Medal; retired October 2, 1963.

CPO LLOYD JOHN McINNIS; C2ER4; joined October 3, 1938; served in *Naden, Restigouche, Stadacona, Cornwallis, Hochelaga II, Lanark, Peregrine, Scotian, West York, Avalon, Humberstone, HMS Puncher, Micmac, Charlottetown, Rockcliffe, Stettler, Nonsuch, Margaree, Antigonish, Athabaskan, Cayuga, Sioux*; awarded LS and GC Medal; retired October 2, 1963.

CPO HENRY CECIL MORGAN; C1ST4; joined October 3, 1938; served in *Naden, Armentieres, Chilliwack, Avalon, Protector, Morden, Stadacona, Niobe, HMS Battler, Warrior, Givenchy, Griffon, Athabaskan, Rockcliffe, Ontario, Cayuga, Cape Breton, Discovery*; awarded LS and GC Medal; retired October 2, 1963.

CPO ALECK METHUON MUSE, CD; C2ER4; served in RCNVR September 28, 1942, to November 20, 1945; joined RCN May 25, 1946; served in *Chippawa, Naden, Givenchy, Stadacona, Avalon, Fennel, Peregrine, Stettler, Shelburne, Chippawa, Uganda, Warrior, Magnificent, Cayuga, Antigonish, Stettler, Digby, Cornwallis, Ontario, Ottawa*; retired October 25, 1963.

CPO DAVID MOFFATT NAYSMITH, CD; C2ER4; joined January 15, 1940; served in *Naden, Stadacona, Fundy, Niagara, Assiniboine, Niobe, Saskatchewan, Cornwallis, Peregrine, Qu'Appelle, Nootka, Givenchy, Cayuga, Antigonish, Rockcliffe, Cayuga, Sioux, Athabaskan, Fraser, Skeena*; retired October 10, 1963.

CPO WILLIAM ALBERT ROBINSON; C1BN4; joined October 3, 1938; served in *Naden, Ottawa, Stadacona, HMS Victory, HMS Excellent, Skeena, Cornwallis, Niobe,*



Although HMCS Ottawa was taken in hand for conversion only on May 24 last, she appeared on Ottawa's Sparks Street mall during the summer equipped with variable depth sonar, helicopter platform and hangar. The 30-foot model of a converted St. Laurent class destroyer escort proved to be a real crowd stopper and a favourite with tourists. After six weeks on the mall, the model was shipped to Toronto to put in an appearance at the Canadian National Exhibition. (O-15022)

Avalon, HMS Puncher, Peregrine, Givenchy, Algonquin, Sioux, Rockcliffe, Ontario, Non-such, Venture, Ottawa, Chippawa; awarded LS and GC Medal; retired October 2, 1963.

CPO GORDON JAMES SCOUGAL, CD and 1st Clasp; C2LT4; joined October 5, 1938; served in *Naden, Ottawa, Stadacona, Reindeer, Cornwallis, Gananoque*, RNO Port Arthur, *Givenchy New Waterford, HMS Ferret, Stormont, Outremont, Peregrine, Niobe, Crescent, Magnificent, Ste. Therese, Stadacona, Jonquiere, St. Laurent, Cape Breton, Rockcliffe, Matsqui, Niagara, Ontario*; retired October 4, 1963.

CPO GEORGE VINCENT SMITH, CD; C2BN4; joined October 7, 1938; served in

Naden, Ottawa, Stadacona, Niobe, Sunbeam, Athabaskan, RN Gunnery School, Chatham, Excellent, Restigouche, Stamshaw Camp, Algonquin, Peregrine, Cornwallis, Crusader, Peregrine, Iroquois, Patriot, York, Givenchy, Ontario, Nootka, Haida, Huron, Crescent; retired October 6, 1963.

CPO WILLIAM ALLEN STEADMAN, CD; C2WU4; joined October 3, 1938; served in *Naden, Restigouche, Stadacona, Renard, Protector, ML056, ML051, Avalon, Winnipeg, Niobe, Warrior, Uganda, Ontario, Antigonish, Sioux, Sault Ste. Marie, Ste. Therese, Cornwallis, Athabaskan, Saguenay*; retired October 2, 1963.

CPO ROGER WILLIAM UNWIN: CIAT3; joined October 12, 1948; served in *Niobe, Stadacona, Shearwater, Bytown, Magnificent, York, VS-880*; awarded LS and GC Medal; retired October 11, 1963.

PO WILLIAM STANLEY WHITTAKER, CD; P1WA3; joined July 6, 1943; transferred to RCN July 4, 1944; served in *Hunter, Cornwallis, Stadacona, Avalon, Peregrine, Niobe, HMS Turnstone, HMS Fledgling, HMS Condor, HMS Pintail (803), HMS Owl, Warrior, RCNAS Dartmouth, (18thCAG), Magnificent, (18CAG), Shearwater (VU32), Magnificent (30CAG), Magnificent (VS881), Shearwater (VS880), York, (VC920), Shearwater (18-CAG), Shearwater (1TAG)*; retired October 24, 1963.

OFFICERS RETIRE

LT.-CDR. RICHARD EDWARD BARTLETT, CD; transferred from the RN to RCNVR on November 22, 1945, as Lieutenant (P); transferred to RCN on January 14, 1947; served in *HMS Vulture, HMS Peewit, HMS Ringtail, HMS Gannet, Warrior, Stadacona, Naden, Niobe, Magnificent, Shearwater, Sioux, Bytown, Crescent, Quebec*; last appointment, *Naden*, on staff of Flag Officer Pacific Coast as Assistant Secretary; commenced leave, October 7, 1963; retires on April 21, 1964.

(Lt.-Cdr. Bartlett, born in Fort Qu'Appelle, Sask., joined the Fleet Air Arm as a midshipman in 1938, was shot down in 1940 over Norway and was a prisoner in Germany until the end of the war.)

LT.-CDR. OSWALD GUY BRACKETT, CD; joined RCNVR March 31, 1931; discharged June 18, 1935; entered RCNR June 7, 1940, as Motor Mechanic; demobilized July 31, 1945; joined RCN February 22, 1946, as Engine Room Artificer, 4th class; promoted to Acting Commissioned Engineer, July 1, 1950; served in *Stadacona, Laurier, Hochelaga, Dundalk, Peregrine, Halifaxian, Micmac, Iroquois, Cayuga, Athabaskan, La Hullose, Haida, Huron, Cornwallis, Ontario, Bytown, Nootka*; last appointment *Stadacona* on staff of Manager Engineering; commenced leave October 13, 1963; retired on March 31, 1964.

LT.-CDR. JOHN WARREN CORYELL, CD; joined RCNVR January 31, 1942 as an Ordinary Seaman; promoted to Probationary Sub-Lieutenant on February 15, 1943; transferred RCN December 12, 1945; served in *Star, Cornwallis, Stadacona, Kings, Moose Jaw, Avalon, Cap de la Madeleine, Coppercliffe, Naval Headquarters, York, Magnificent, Naden, Patriot*; last appointment *Patriot* on staff of COND as Staff Officer Technical, commenced leave on August 31, 1963; retires on March 11, 1964.

CDR. JOHN FRANCIS COSGROVE, CD; joined RCNVR August 1, 1942; transferred to RCN September 10, 1946; served in *Montcalm, Bytown, Hochelaga, Cornwallis, Stadacona, Niobe, Givenchy, Scotian, Ontario, Niagara, Naden*; last appointment, *Niagara* on staff of Naval Member Canadian Joint Staff Washington as Staff Officer Intelligence; commenced leave on September 20, 1963; retires on February 23, 1964.

CDR. NEVILLE SPENCER CHARLES DICKINSON, CD; served in RCNVR from May 18, 1935, to October 25, 1938, and from September 27, 1939 to August 23, 1945; joined RCNR November 9, 1946; transferred to RCN January 23, 1951; served in *Stadacona, HMS*

Alfred, HMS Seaborn, Kings, HMS Veteran, Kamloops, Timmins, HMS Lightfoot, Hespeler, Avalon, Niobe, Bytown, Crusader, Niobe, Niagara; last appointment on attachment to Saclant as Director Annual Review, with acting rank of captain; commenced leave October 14, 1963; retires on February 15, 1964.

LT.-CDR. THOMAS DOCKER, CD; joined RCN February 7, 1938; as an Acting Engine Room Artificer 4th Class; promoted to Acting Warrant Engineer on February 1, 1942; served in *Naden, Restigouche, HMS Pembroke, HMS Comet, Stadacona, Pictou, HMS Calliope, Niobe, Uganda, Scotian, Huron, Micmac, Warrior, Crescent, Bytown, Quebec, Cape Scott*; last appointment *Stadacona* on staff of Base Superintendent Sydney as Assistant Superintendent; commenced leave on August 31, 1963; retires on April 3, 1964.

CDR. JOHN RONALD DOULL, CD; joined RCNVR October 5, 1940; transferred to RCN November 1946; joined as an Ordinary Seaman; promoted to Lieutenant on May 22, 1941; served in *Stadacona, HMS Victory, HMS King Alfred, HMS Proserpine, HMS Royal Arthur, Niobe, HMS Heron, HMS Nigeria, Warrior, HMS Kete, Bytown, Magnificent, Shearwater, Naden, Niagara*; last appointment *Niobe* as Assistant to the Canadian Naval Member Military Agency for Standardization; commenced leave on September 9, 1963; retires on March 27, 1964.

LT.-CDR. EARL ALONZO GRANT, CD; joined RCNVR July 27, 1940 as an Ordinary Seaman; promoted to Probationary Sub-Lieutenant May 24, 1943; demobilized August 22, 1945; entered the RCN(R) October 27, 1947; transferred to RCN February 3, 1951; served in *Stadacona, Cornwallis, Kings, Wallaceburg, Niobe, Queen, Iroquois, Haida, New Liskeard, Naden, York, St. Therese, Chippawa, Bytown, Givenchy, Wasaga, Kenora*; last appointment Naval Headquarters, on staff of Assistant Director Naval Manning (Recruiting); commenced leave October 18, 1963; retires on March 9, 1964.

LIEUTENANT DAVID ELLIS JONES, CD; joined RCNR as a probationary steward; transferred to RCN November 26, 1942; promoted to acting commissioned catering officer September 15, 1950; served in *Naden, Givenchy, HMS Puncher, Burrard, Stadacona, Uganda, Crescent, Rockcliffe, Sioux, Cornwallis, Ontario, Shearwater, Discovery*; last appointment *Discovery* on Staff of Area Recruiting Officer British Columbia for Mobile Recruiting Unit 3; commenced leave October 15, 1963; retires on May 3, 1964.

CDR. BERNARD SUMMERS LAKE, CD; joined RCNVR as a Probationary Sub-Lieutenant June 19, 1941; demobilized January 31, 1946; entered the RCN(R), November 12, 1946; transferred to the RCN November 29, 1946; served in *Chippawa, Queen, Royal Roads, Venture, Stadacona, Cornwallis, Mordean, Niobe, Ontario, Naden, Ontario, Bytown*; last appointment, Naval Headquarters on staff of Director Naval Training as Assistant Director Naval Training, Men; commenced leave on September 20, 1963; retires on March 1, 1964.

CDR. VICTOR FREDERICK O'CONNOR, CD; joined RCN August 18, 1934, as Acting Engine Room Artificer 4th class; promoted to Acting Warrant Engineer on February 1, 1942; served in *Renard, Stadacona, Avalon, Niobe, HMS Bellona, Ontario, Scotian, Iroquois, Bytown, Magnificent, York*; last appointment *Stadacona*, on staff of Commodore Superintendent Atlantic Coast as Engineering Shops Officer Naval Armament Depot Dartmouth; commenced leave July 8, 1963; retires on March 1, 1964.

LT.-CDR. ROBERT McMILLAN RIDDELL, CD; joined RCNVR December 13, 1927, as an Ordinary Seaman; transferred to RCN January 9, 1929; served in *Naden, Stadacona, HMS Victory, HMS Nelson, HMS Champion, Skeena, Armentieres, St. Laurent, St. Hyacinthe, Bytown, Burrard, Givenchy, Warrior, Niobe, Magnificent, Crusader, Ontario*; last appointment *Naden* for Engineering Division; commenced leave November 2, 1963; retires on July 28, 1964.

SURGEON CAPTAIN HENRY ROBERTSON RUTTAN, OBE, CD; transferred from RNVN on March 15, 1941; transferred to RCN February 27, 1946; served in *Stadacona, Niobe, Givenchy, Burrard, Naden, Bytown, Ontario, Cornwallis*; last appointment Naval Headquarters for National Defence Medical Centre as Regional Consultant in Dermatology; commenced leave October 7, 1963; retires on April 24, 1964.

LT.CDR. ROY HOWARD SYLVESTER, CD; joined RCNVR December 13, 1940, as Probationary Sub-Lieutenant; demobilized January 17, 1946; joined RCN June 3, 1946; served in Naval Headquarters, *Royal Roads, Stadacona, Suderoy V, Shelburne, Arrowhead, The Pas, Chaleur, Victoriaville, Cornwallis, Donnacona, York, Bytown, Crescent, Niobe, Assiniboine, Naden, Hochelaga*, last appointment Naval Headquarters on staff of Director Naval Intelligence; commenced leave October 20, 1963; retires on March 1, 1964.

Naval Lore Corner

Number 121 GUNS WITH DOUBLE LIVES...

ONE OF THE BIGGEST PROBLEMS IN NAVAL CONSTRUCTION WAS THE SUPPLY OF THE BIG GUNS. THE FOUR GIANT BRITISH BATTLESHIPS OF THE "LION" CLASS WERE CANCELLED, AFTER CONSTRUCTION HAD BEGUN, IN 1940 BECAUSE THEIR MAIN ARMAMENT OF NINE 16-INCH GUNS COULD NOT BE DELIVERED IN TIME FOR THE SHIPS' SCHEDULED COMPLETION...

AS AN ALTERNATIVE, H.M.S. VANGUARD WAS BUILT TO A NEW DESIGN IN ORDER TO UTILIZE GUNS THAT ALREADY EXISTED. HER 15-INCH GUNS PREVIOUSLY SAW ACTION ABOARD THE BATTLECRUISERS "GLORIOUS" AND "COURAGEOUS" OFF HELIGOLAND IN 1917...THUS HER GUNS WERE FIRED IN ANGER 30 YEARS BEFORE "VANGUARD" COMMISSIONED! "GLORIOUS" AND "COURAGEOUS" WERE CONVERTED INTO CARRIERS AND THEIR GUNS WERE STORED UNTIL VANGUARD WAS BUILT...BUT TOO LATE FOR WORLD WAR II...SHE WAS THE LAST OF THE BRITISH BATTLESHIPS...

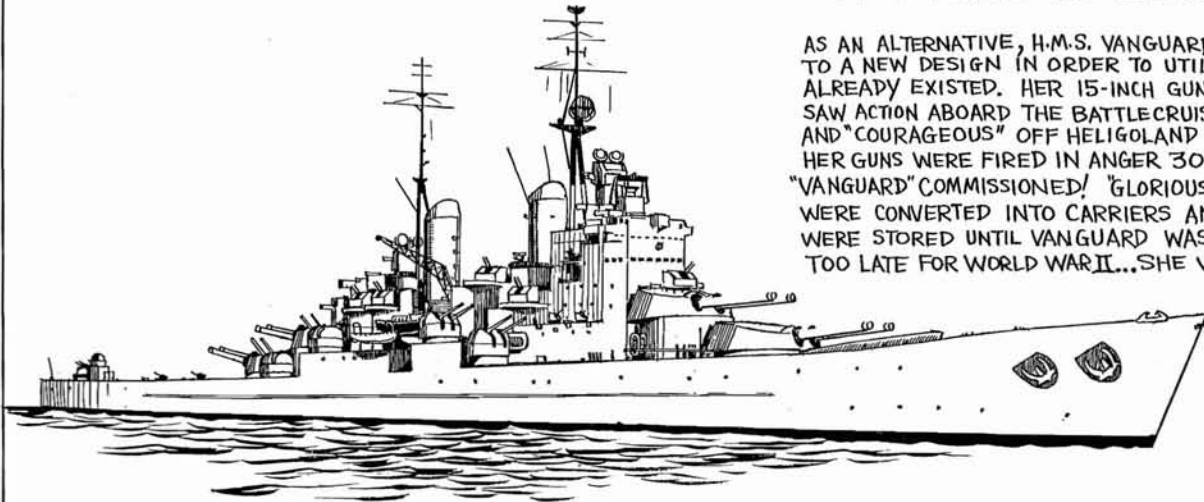

DURING THE ABYSSINIAN CRISIS IN 1935, THE ROYAL NAVY WAS HURRIEDLY "BEEFED UP" TO BOLSTER THE MEDITERRANEAN FLEET. THE OLD CRUISER "CURLEW" WAS CONVERTED INTO AN ANTI-AIRCRAFT CRUISER, BUT THERE WAS SUCH A SHORTAGE OF WEAPONS, THAT, IN ORDER TO COMPLETE HER ARMAMENT, A 4-INCH GUN WAS TAKEN FROM THE IMPERIAL WAR MUSEUM!

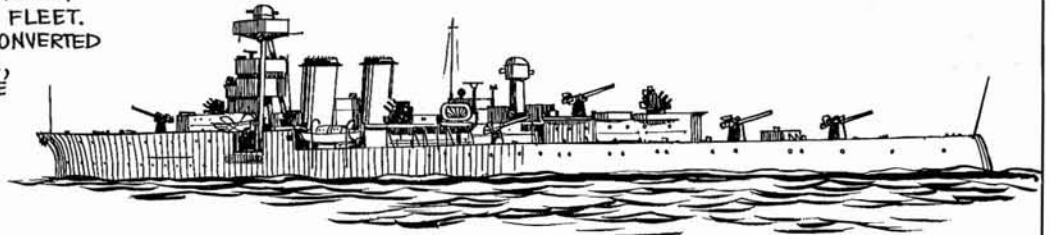

THE CANADIAN AUXILIARY CRUISER H.M.C.S. PRINCE ROBERT, AS FIRST CONVERTED IN 1940, WAS ARMED WITH FOUR 6-INCH GUNS OF FIRST WORLD WAR VINTAGE, OBTAINED FROM THE ADMIRALTY...

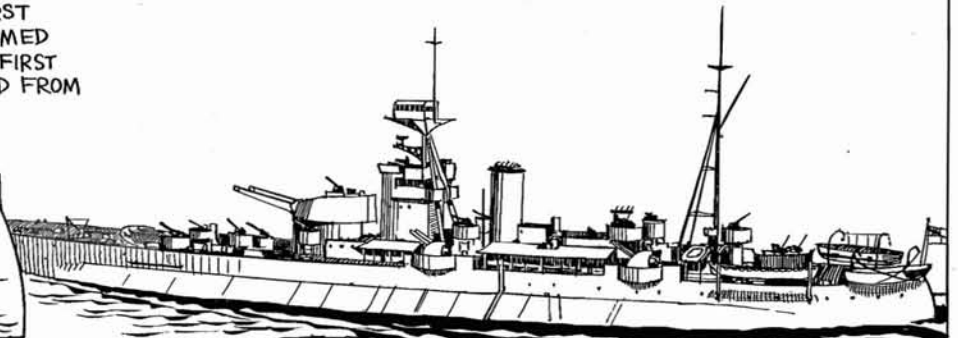
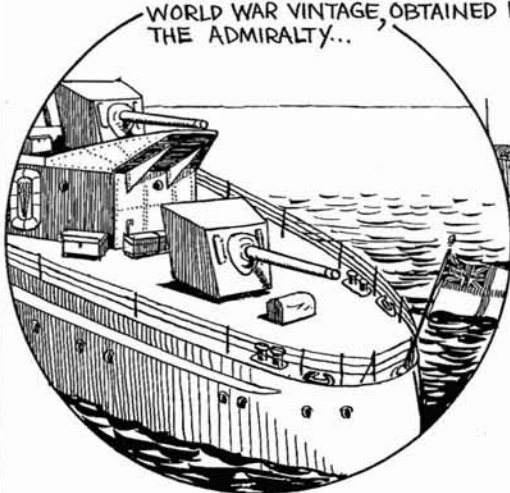

THE BRITISH MONITORS H.M.S. ABERCROMBIE AND ROBERTS, COMMISSIONED IN 1941-42 MOUNTED THE ORIGINAL MAIN ARMAMENT (2-15 INCH GUNS) OF THE FIRST WORLD WAR MONITORS OF THE "MARSHAL SOULT" CLASS...WHICH HAD BEEN DISCARDED AS FIGHTING UNITS YEARS BEFORE....

Roger Duhamel

QUEEN'S PRINTER—IMPRIMEUR DE LA REINE

DEPT. OF NAT. DEFENCE,
LIBRARY,
ROOM 1082 - C - BLDG.,
OTTAWA, ONT. CRO.F.

If undelivered return to:

The Queen's Printer, Ottawa, Canada

En cas de non-livraison, retourner à:

L'Imprimeur de la Reine, Ottawa, Canada



The CROWSNEST

(c2)

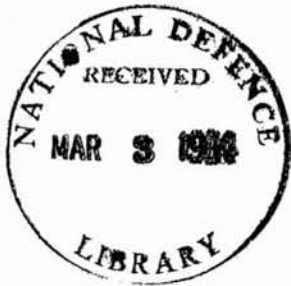

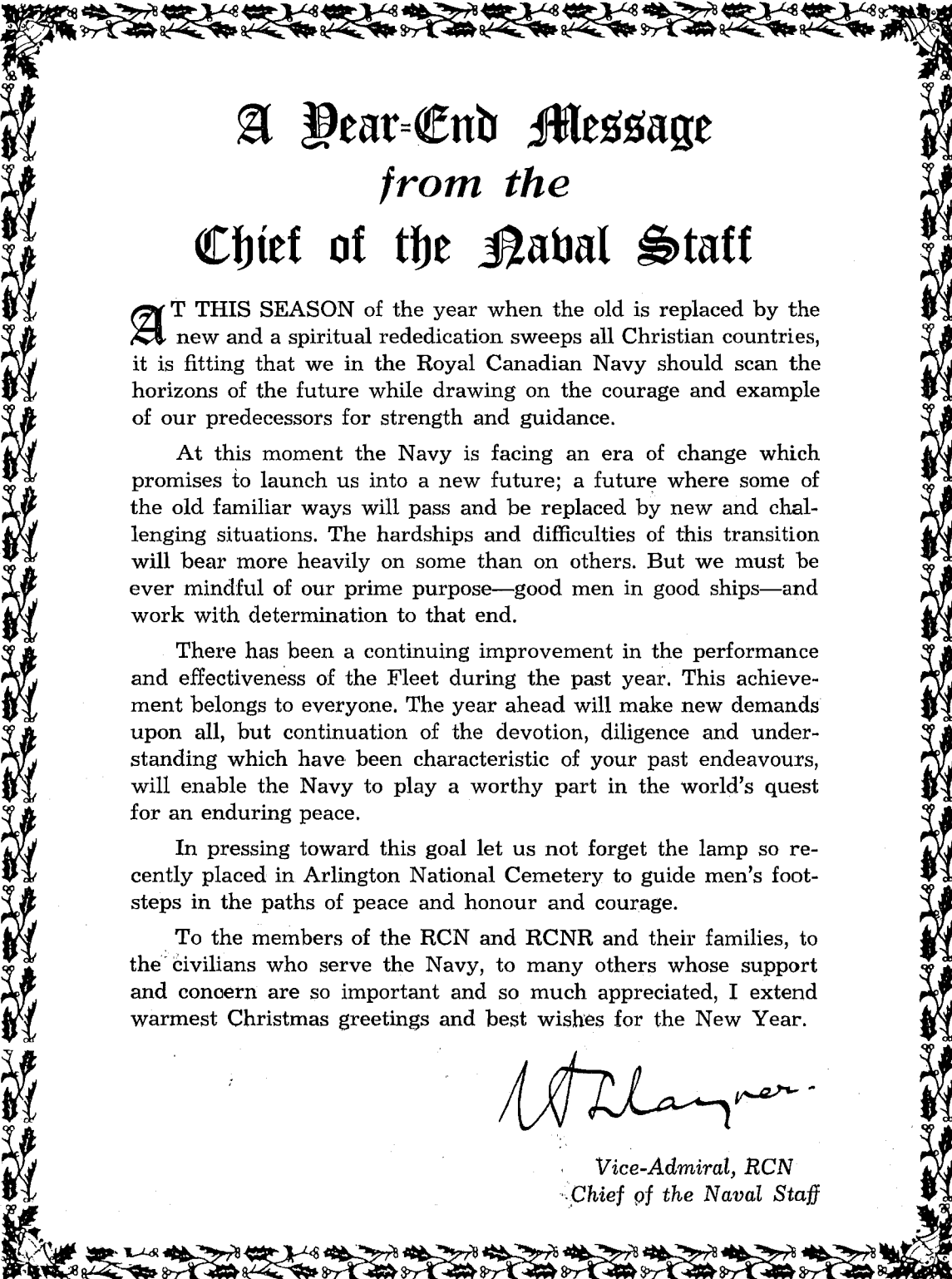

A Year-End Message from the Chief of the Naval Staff

AT THIS SEASON of the year when the old is replaced by the new and a spiritual rededication sweeps all Christian countries, it is fitting that we in the Royal Canadian Navy should scan the horizons of the future while drawing on the courage and example of our predecessors for strength and guidance.

At this moment the Navy is facing an era of change which promises to launch us into a new future; a future where some of the old familiar ways will pass and be replaced by new and challenging situations. The hardships and difficulties of this transition will bear more heavily on some than on others. But we must be ever mindful of our prime purpose—good men in good ships—and work with determination to that end.

There has been a continuing improvement in the performance and effectiveness of the Fleet during the past year. This achievement belongs to everyone. The year ahead will make new demands upon all, but continuation of the devotion, diligence and understanding which have been characteristic of your past endeavours, will enable the Navy to play a worthy part in the world's quest for an enduring peace.

In pressing toward this goal let us not forget the lamp so recently placed in Arlington National Cemetery to guide men's footsteps in the paths of peace and honour and courage.

To the members of the RCN and RCNR and their families, to the civilians who serve the Navy, to many others whose support and concern are so important and so much appreciated, I extend warmest Christmas greetings and best wishes for the New Year.



Vice-Admiral, RCN
Chief of the Naval Staff

The CROWSNEST

Vol. 15 No. 12

THE ROYAL CANADIAN NAVY'S MAGAZINE

DECEMBER 1963

CONTENTS

	Page
<i>RCN News Review</i>	2
<i>The Navy in 1964</i>	5
<i>Venture Plan Ends</i>	6
<i>Messages from the Ministers</i>	7
<i>A Dog's Life</i>	8
<i>Officers and Men</i>	11
<i>Weddings and Births</i>	11
<i>Home from the Sea</i>	15
<i>Here and There in the RCN</i>	16
<i>Afloat and Ashore</i>	18
<i>Books for the Sailor</i>	22
<i>The Navy Plays</i>	24
<i>Ideas into Dollars</i>	26
<i>Retirements</i>	28
<i>Naval Lore Corner No. 122</i>	<i>Inside Back Cover</i>

The Cover—In evergreen British Columbia every photo is a Christmas card. This shows HMCS *Mackenzie* in aptly named Calm Channel, near the mouth of Bute Inlet. In the foreground is the Indian village of Church House and across the water are Maurelle and Sonora Islands. (CCC2-1247)

The Crowsnest Extends to Its Readers All Best Wishes for the New Year

Negative numbers of RCN photographs reproduced in *The Crowsnest* are included with the caption for the benefit of persons wishing to obtain prints of the photos.

This they may do by sending an order to the Naval Secretary, Naval Headquarters, Ottawa, attention Directorate of Naval Photography, quoting the negative number of the photograph, giving the size and finish required, and enclosing a money order for the full amount, payable to the Receiver General of Canada.

Sizes, finish and the National Defence standardized prices, follow:

4 x 5 (or smaller) glossy finish only ..	\$.10
6½ x 8½ glossy finish only40
8 x 10 glossy or matte finish50
11 x 14 matte finish only	1.00
16 x 20 " " "	3.00
20 x 24 " " "	4.00
30 x 40 " " "	8.00

SUBSCRIPTION RATE

The Crowsnest may be subscribed for at the rate of \$2 a year; outside of North America, \$3. Orders, accompanied by cheque or money order payable to the Receiver General of Canada, should be sent to:

THE QUEEN'S PRINTER,
Department of Public Printing
and Stationery,
OTTAWA, Ontario

Communications, other than those relating to subscriptions, should be addressed to:

EDITOR,
The Crowsnest,
Naval Headquarters,
OTTAWA, Ontario.



RCN NEWS REVIEW

A cruise to Pearl Harbour and points west was the first operational undertaking of the newly converted St. Laurent early in the New Year. She is pictured with her new hangar and flight deck during autumn trials in the Pacific Command. (E-74495)

Jonquiere First In A/S Standing

The 1963 Pacific Command anti-submarine proficiency award, competed for by ships of the Fourth Canadian Escort Squadron, has been won by HMCS *Jonquiere* with 82.6 points. The runner-up was HMCS *Beacon Hill*, less than two points behind with a score of 80.8.

Rear-Admiral W. M. Landymore, Flag Officer Pacific Coast, commended both frigates for their high score and extended particular congratulations to the *Jonquiere*.

Assiniboine on Flying Trials

The converted destroyer escort HMCS *Assiniboine* began flying trials with the Sea King (CHSS-2) helicopter out of Halifax during the first week in December.

During the same period the *St. Laurent*, second ship to undergo conversion, was carrying out sea trials on the West Coast and two other *St. Laurent* class destroyer escorts, the *Ottawa* and *Saguenay*, were in shipyard hands being fitted with helicopter facilities and variable depth sonar.

The *Ottawa* is expected to return to service early in 1964.

On December 3, Rear-Admiral J. V. Brock, Flag Officer Atlantic Coast, sent the following message:

"Due to a concerted effort by the many agencies involved, the *Assiniboine*

begins the flying phase of her program this week as planned.

"Please convey my congratulations to all the Dockyard workers who tackled the problem with such enthusiasm and vigour. Well done."

Admiral Lauds Exercise Units

Admiral Sir Charles Madden, Commander-in-Chief of NATO's Eastern Atlantic area, sent the following message to air and sea components October 28, to wind up NATO Exercise Flatrock:

"On the dispersal of the NATO forces assembled for Flatrock, I wish to congratulate all who took part. The spirit of enthusiasm shown by all made this exercise a success despite the adverse weather. Another step forward in the practical co-operation between our national naval and air forces has been made. I look forward to our next meeting. Goodbye and good luck."

The British admiral spent October 22-24 on board the Canadian aircraft carrier *Bonaventure* during the exercise in a stormy northeastern Atlantic. The Canadian components included four Halifax-based ships and three RCAF Argus aircraft from Greenwood, N.S. Altogether, more than 30 ships from Britain, Denmark, France, The Netherlands, Norway and Canada were involved.

Ships Sail on Pacific Cruise

Three destroyer escorts of the Pacific Command of the RCN were to sail January 7, on a training cruise in the Pacific.

The ships are the *St. Laurent*, *MacKenzie*, and *Fraser*, of the Second Canadian Escort Squadron. The squadron commander is Captain G. H. Hayes embarked in HMCS *Fraser*.

First port of call was to be Pearl Harbour.

Naval Housing For Dartmouth

A brief ceremony on November 29 marked the beginning of a new era in housing for Royal Canadian Navy personnel in the Halifax-Dartmouth area when the first eight of 397 "private enterprise" housing units in North Dartmouth become available for naval occupancy.

At the ceremony Layton Dempsey, representing the builder and owner, Murray Elias of Dartmouth Investment Ltd. introduced Mayor I. W. Akerley, of Dartmouth, who declared the housing project open. Mr. Dempsey then turned over the keys for the new units to Commodore Ralph L. Hennessy, Commodore Personnel Atlantic Coast, who in turn presented the keys of one of the houses to the first occupant, AB John Woodford, now serving in HMCS *Granby*. AB Woodford and his wife Joan, have six children, ranging in age from infancy to 10 years.

The project, named Wallis Heights after the famous Halifax-born Admiral of the Fleet Sir Provo Wallis, represents a new departure in housing for naval personnel. Becoming available over the next 12 months, the 64 four-bedroom and 333 three-bedroom houses and maisonettes are being built by Dartmouth Investment Ltd. under an agreement with the Department of National Defence and Central Mortgage and



All Canadians shared in the grief and dismay of their southern neighbours when on November 22 President John F. Kennedy died the victim of an assassin's bullet. On that sad day and during the period of mourning that followed, ensigns in RCN ships and establishments were at half-mast. The destroyer USS Charles Berry entered Esquimalt Harbour at the precise moment that Commissionaire J. Leek was lowering the ensign at Duntze Head at the harbour entrance on the day of the assassination.

Indian Name For RN Ship

Canadian High Commissioner George Drew was not only invited to the commissioning of HMS *Mohawk* November 29 at Vickers Armstrong in Britain, he was also asked to address the ship's company—and with good reason.

The general-purpose frigate boasts a fine North American Indian name, one that at least eight other warships of the Royal Navy have borne. Some of them were either Canadian-built or operated in this country's waters during colonial wars.

The first recorded HMS *Mohawk* was a sloop out of Oswego on Lake Ontario. She was destroyed the same year when Montcalm's forces took Oswego. The second was a snow from Oswego which took part in the land inland battle of the British and French below Fort Levis in the St. Lawrence in 1760. The third was a schooner on Lake Ontario from 1781 to the early 1800s. There is uncertain reference to another, Kingston-built schooner of 1802-3. Naval historians don't count her.

The fourth *Mohawk* was a steam paddle sloop at Kingston in 1845-6; the time of the "Fifty-Four Forty or Fight" fuss. She was not only the first iron-hulled warship on the Lakes but also the first effective fighting ship of iron hull in the RN. She operated from 1846 in Lake Erie and in Georgian Bay to 1852.

Of the *Mohawks*, the sixth was also of interest to Canada. She was a third-class cruiser at Halifax with the North America and West Indies squadron towards the turn of the century. The eighth was a Tribal class destroyer torpedoed and sunk in the Mediterranean in 1941.

Housing Corporation. Dartmouth Investment Ltd. retains ownership under a long-term mortgage and lease arrangement.

Allocation of the units is the responsibility of the RCN Housing Administrator.

The houses incorporate the latest advances in accommodation and it is expected they will assist materially in easing the shortage of housing for naval personnel in the area.

Air Crash Kills Two Naval Pilots

Funeral services were held on November 29 at HMCS *Naden* for two Pacific Command pilots who died on November 23 when their T-33 jet plane crashed into a mountain near Vancouver.

The final rites were for Lt. Donald S. Clark, 29, and Lt. Norman J. Ogden, 33, both with homes and families in Victoria.

Held in the Protestant chapel of HMCS *Naden*, the service was conducted by Command Chaplain (P) A. J. Mowatt, assisted by Chaplain (P) W. L. Dalton. Burial took place in the Veterans' Cemetery, close to the naval barracks.

Attached to VU-33, the RCN's utility squadron at Patricia Bay, the plane had left that base on the morning of November 23 for ground-controlled landing exercises at the RCAF Sea Island base near Vancouver. The jet disappeared from radar tracking screens about 20 minutes after take-off.

A search was started immediately with a host of ships and aircraft taking part.

On November 26 an RCN helicopter piloted by Sub-Lt. Ian A. Powick spotted the wreckage scattered over a large area of jagged rocks and tall trees at the 4,500-foot level of Mount Strachan, 12 miles north of Vancouver. The bodies were recovered the next day.

Army Joins Navy In Fleet Exercise

The Royal Canadian Navy and the Canadian Army co-operated in a series of fleet operations off the northeast coast of Nova Scotia early in December.

Designated "Exercise Boat Cloak," the manoeuvres were held in the area of Madame Island, east of the Strait of Canso, from December 2 to 13.

Twenty ships of the Navy's Atlantic Command, manned by approximately 3,500 officers and men, participated in

the operations, together with approximately 200 officers and men from Camp Gagetown, New Brunswick, and naval aircraft from *Shearwater*.

The Army provided patrol, signals and reconnaissance groups, landing parties and interrogation teams, as well as personnel for liaison duties aboard ship.

RCN units participating included destroyer escorts, seven frigates and three minesweepers.

First Sea Lord Visits Canada

The First Sea Lord of the British Admiralty, Admiral Sir David Luce, visited Ottawa, November 26 to 28, and Atlantic Command headquarters in Halifax, November 29 and 30.

In Ottawa he conferred with Hon. Paul Hellyer, Minister of National Defence, and senior officers of the Armed Forces.

This was Admiral Luce's first visit to Canada since assuming his appointment in August.

Safe Driving Week Observed

The Atlantic Command observed Safe Driving Week, December 1 to 7, with extensive programs designed to stimulate safe driving throughout the year.

At HMC Dockyard, Halifax, in addition to safe driving slogans and signs, the Command Motor Transport Safety Officer arranged for pamphlets to be distributed. Safety films were shown in

many of the shops. At the North and South gates, grisly but graphic displays depicted the results of carelessness behind the wheel.

On December 3 personnel at the dockyard and from HMC ships had the opportunity of taking a provincial driver's test. Two days later Halifax City Police carried out free vehicle inspections at the Dockyard.

Other naval establishments in the Atlantic Command carried out similar campaigns to promote the aims of the Canadian Highway Safety Council, sponsors of Safe Driving Week.

Co-ordinator for the Navy was George Little, Command Motor Transport Safety Officer at HMC Dockyard.

COs of Divisions Meet in Hamilton

The 15th annual conference of the commanding officers of Canada's naval divisions was held in Hamilton November 19 to 22 at the headquarters of Commodore P. D. Taylor, Commanding Officer Naval Divisions.

Naval reserve matters discussed during the conference included: personnel, training, administration, supply, maintenance, financial control, University Naval Training Divisions and Royal Canadian Sea Cadet Corps.

The commanding officers, representing Royal Canadian Naval Reserve establishments across Canada from Newfoundland to British Columbia, visited Ottawa by RCAF aircraft on November 21 to meet senior officers at Naval Headquarters.



NOA SCHOLARSHIPS

THREE SCHOLARSHIPS have been awarded to members of the Royal Canadian Naval Reserve by the Naval Officers' Association of British Columbia for study at the University of British Columbia and Victoria University.

The winners are Ldg. Wren Dawn Gray, of HMCS *Discovery*, a third-year arts student taking a combined honours course in Asian studies and French; Lt. R. T. Walker, RCNR, Staff Officer UNTD at Victoria University and HMCS *Malahat* and UNTD Cadet Simon Whitlow, who is a third-year arts (honour chemistry) at UBC.

The scholarships are valued at \$150 each.

Miss Gray is the first female winner of an NOA scholarship. She plans on graduation to apply for a position with the Department of External Affairs.

Lt. Walker is a graduate of the Venture Plan and served a total of eight

years in the RCN before resigning to study medicine at Victoria University. He plans to re-enrol in the Navy under terms of the 45-month medical undergraduate subsidization plan.

Cadet Whitlow spent two years at Victoria University before entering UBC. On graduation, he plans to enter the field of industrial research.

All three winners speak highly of their naval training as a valuable supplement to their academic studies.

Since 1960, the Naval Officers' Association of British Columbia has awarded nine scholarships, and has advanced almost \$3,000 in bursary-loans. Preference is given in the selection of candidates to those who are present or former members of a cadet force, the reserve, or sons and daughters of present or former members of Commonwealth naval forces or the Merchant Navy.

For several months during 1963 RCSCC Falkland, the Ottawa sea cadet corps, had the distinction of having four brothers in training at one time. Sons of Mrs. Lucienne Dupuis, of Ottawa, and all of them students at Ottawa Technical High School, they are (bottom to top) Daniel, 14, Robert, 16, Paul, 17 and John, 18. The older brothers, Paul and John, joined RCSCC Fort Lennox, Grande Linge, Que., early in 1959 and transferred to Falkland later that year. John left the corps last September as a petty officer. Paul, a petty officer, first class, is senior cadet of the corps this year, Robert is a leading cadet instructor and Daniel, who entered last March, is an ordinary cadet. The three seniors have been outstanding cadets and have won individual awards for efficiency. (O-15184)

Much as naval personnel may regret the passing of familiar ships and establishments, some positive factors have emerged from the naval cutbacks.

These were outlined in a general message to the Fleet as follows:

"For some time the Navy has been short of skilled men in certain higher trade groups and there has been an urgent need to bring commitments more in line with manpower resources. The balance between commitments and manpower will now be greatly improved, thus permitting a better distribution of trained manpower in our operational forces than has hitherto been possible, and also improving our ability to provide the trained men we need.

"As previously stated by the Minister, 'Our aim is to find ways and means of reducing overhead and, by cutting operation and maintenance costs, achieve a redirection of expenditures to improve our defensive capability.' By making the reductions which have been announced it will be possible to allocate a higher percentage of the funds available for new equipment and other improvements in overall effectiveness.

"The improvements which are already underway include the continuation of the modernization of the St. Laurents, the commissioning of two Mackenzie class destroyer escorts in 1964, the acquisition of three Oberon submarines, with the first of these entering service in 1965, and the provision of additional CHSS-2 helicopters."

THE RCN IN 1964

A FAIRLY COMPREHENSIVE picture of reductions in operational strength and supporting units of the Royal Canadian Navy during 1964 emerged with the turn of the year.

A message from Vice-Admiral H. S. Rayner, Chief of the Naval Staff, on December 5, said, in part:

"When budgetary considerations dictate a reduction in the shape and size of the naval force, it is always extremely difficult to select the areas from which the savings must be realized. The reductions which have been announced were decided upon after thorough consideration of all possible alternatives.

"It is realized that the closing of the facilities and establishments listed will have serious consequences for many of the loyal civilian employees of the Navy. Every effort will be made to relocate such personnel with other government departments and agencies wherever possible.

"The reduction in the Naval Reserve is governed by the need to curtail costs and at the same time to maintain a viable and effective reserve. The role of the RCNR remains unchanged and the present standard of training will be maintained because an effective RCNR is indispensable to the country's naval effort.

"Within the funds which will become available it will be possible to continue existing approved programs for the improvement of the fighting effectiveness of the fleet...

"At this time, the full co-operation and understanding of all personnel both naval and civilian is essential to enable the task of paying off the units and establishments listed to proceed smoothly and expeditiously."

The reductions, announced in two phases, affect both the RCN and RCNR, ships, shore establishments and aircraft. They include the following:

- Three additional Tribal class destroyers, Canadian-built and commissioned shortly after the Second World War, will be paid off for disposal. They are the *Cayuga*, *Micmac* and *Nootka*. Of the four Canadian-built Tribals, only HMCS *Athabaskan* will be retained in service.

- Ships of the First Canadian Minesweeping Squadron (*Chaleur*, *Chignecto*, *Fundy*, *Quinte*, *Resolute* and *Thunder*), based at Halifax, and of the Second Canadian Minesweeping Squadron (*Cowichan*, *Fortune*, *James Bay* and *Miramichi*), based at Esquimalt, will be paid off and placed in reserve. These are the only minesweepers in service in the RCN.

- The West Coast mobile repair ship, HMCS *Cape Breton*, will be paid off to reserve.

- Ten auxiliary vessels will be taken out of service. These include two small stores ships, two 46-foot harbour ferries, two 75-foot harbour ferries, one fire tug, two Glen class tugs, and one Saint class tug. The one Saint class tug will be placed in reserve.

- HMCS *Acadia*, summer training establishment for Sea Cadets at Point Edward Naval Base, will not open, but the facilities will be retained under care and maintenance. Sea Cadet training will be conducted on a reduced scale at HMCS *Cornwallis* and HMCS *Quadra*.

- Reserve officer cadet training in the universities will be reduced by about 50 per cent. This reduction will affect the UNTD, COTC and URTP. No reductions are contemplated in respect of officer cadets of the regular forces.

- VU-32, the utility air squadron at *Shearwater*, will be reduced by four Trackers and two T-33 jet trainers. VU-33, the utility air squadron at Patricia Bay, B.C., will be reduced by the two HUP-3 helicopters now in service.

- The naval ship repair facility at Point Edward Naval Base will be closed, but the Naval Depot and Records Centre will remain in operation.

- Naval activities at Fort Pepperell, the former U.S. base at St. John's, Nfld., for which the Navy has been providing caretaker service, will be discontinued except for HMCS *Cabot*, the naval division, and the establishment will be transferred to another government agency.

- The RCN Armament Depot at Longueuil, Que., and Ammunition Depot at Kamloops, B.C., will be closed, as will the Naval Supply Depot at Lynn Creek, B.C.

- The following naval divisions will be closed: *Scotian* (Halifax), *Queen Charlotte* (Charlottetown),

Prevost (London), *Queen* (Regina), *Nonsuch* (Edmonton), *Chatham* (Prince Rupert), *Malahat* (Victoria) and the Kitchener tender to HMCS *Star*.

- Reserve air squadrons VC-920, attached to HMCS *York*, Toronto, and VC-922, at Patricia Bay, will be paid off.

- RCN personnel released from the above commitments will be re-absorbed in complement. The RCNR will be reduced to 2,700 officers, men and UNTD cadets.

- Regular force strength of the RCN will be reduced to 20,700 officers and men. This represents a reduction of 793 from the year-end figure of 21,493 and will be reached through normal releases and a temporary slow-down in recruiting.

THE VENTURE PLAN, born in 1954, officially ended on December 20 with the graduation of 20 naval officer cadets whose training commenced two years earlier. The graduating class included five young men from Nigeria.

Graduation day for the last of the Venture Plan cadets started with church services in the morning with the actual graduation ceremony starting at 2:30 p.m. in the HMCS *Venture* gymnasium. Rear-Admiral W. M. Landymore, Flag Officer Pacific Coast, was the inspecting officer.

Graduates and guests then attended a tea in the cadets' gunroom and, later, attended a reception in the *Venture* wardroom. The graduation ball was held in the *Venture* gunroom that night.

Preliminary to the graduation ceremonies was a mess dinner held on December 17.

Promotion to the rank of acting sub-lieutenant for the graduates was effective January 1. Early in the new year, air personnel were to go to sea in frigates of the Pacific Command's Fourth Canadian Escort Squadron.

For the five naval officer cadets from Nigeria, there are still some months to spend with the fleet. Their training throughout the year will lead to upper-deck watchkeeping certificates, and it is expected they will return to their homeland late in 1964 or early 1965.

Major award winners at the graduation ceremonies were headed by Naval Officer Cadet G. C. Gordon, winner of the Officer of the Watch Telescope, awarded by the Department of National Defence to the Venture cadet obtaining highest standings in scholastic and professional subjects and officer-like qualities. He also captured top honours for obtaining the highest aggregate mark in the senior term and top honours in naval knowledge studies. Second high-

VENTURE PLAN ENDS

est honours went to Naval Officer Cadet S. T. Grant.

Naval Officer Cadet M. L. Myrhaugen was awarded the Hampton Gray Shield for outstanding athletic ability and sportsmanship. (This award is presented by the staff officers of the Chief of Naval Personnel in memory of the late Lt. Robert Hampton Gray, VC, DSC, RCNVR).

Cadet B. E. Shaw was judged by his fellow cadets as being "most highly endowed with the qualities of sportsmanship".

Naval Officer Cadet S. R. Price was the winner of the officer's sword, presented by the Navy League of Canada for outstanding officer-like qualities.

Officer Cadet B. M. Thiel won top honours in navigation.

Graduation time for the Venture Plan cadets also marked the conclusion of the first phase of training for the Short Service Officer Plan cadets who commenced their training last September. Several of them received special awards.

They included Naval Officer Cadet C. D. Rainsford, winner of the Venture Officers' Shield, awarded by the officers of HMCS *Venture* to the cadet in early training with highest marks in athletic ability and sportsmanship.

SSOP Cadets J. G. Bergeron, R. Montgomery and I. D. Sparkes all won special awards for making the most progress in a second language (English or French).

In its nine years of operation, the Venture Plan produced 314 officers, many of whom later applied for and were granted permanent commissions. The plan was established primarily to

train officers for naval aviation and it graduated 165 officers to this field. In addition, the Venture Plan produced 149 officers for duty with the surface fleet.

The Venture course was two years in length, and featured a four-month training cruise in the second year. These cruises, in frigates of the Fourth Canadian Escort Squadron, were designed to give the future officers first-hand experience in sea-going life in all departments of the ship. The cruises also provided excellent training in another way, in that Venture cruises took cadets to ports in Europe, Japan, the Indian Ocean, Australia, New Zealand, the South Sea Islands and the Far East. Latterly, the Venture Plan had an even more unique "international" aspect. The final graduating class included five young Nigerian officer cadets.

The new scheme, the RCN Short Service Officer Plan, was approved in the spring of 1963 as a successor to the Venture Plan, and its first class of 73 surface and aviation officer cadets is now undergoing training in HMCS *Venture*.

Like Venture, the SSOP features a seven-year short service appointment, but the new scheme's enrolment qualifications are expected to appeal to a wider range of young Canadians than did the Venture Plan. Venture was restricted to those with junior matriculation standing who had reached their 16th but not their 19th birthday on January 1 of the year of enrolment.

The new scheme is open to young men with junior matriculation standing or better who have reached their 17th but not their 24th birthday on the 1st of January of the year of enrolment. Short Service Officer Plan cadets are paid \$235 a month, the equivalent pay of acting sub-lieutenants.

Messages From The Ministers

Hon. Paul T. Hellyer

Minister of National Defence

As minister of National Defence, I welcome this opportunity to offer my sincere best wishes for a very merry Christmas to the members of the Armed Forces, to the civilian personnel of the Defence Research Board and the Department of National Defence during this season of the year.

As we gather to celebrate the birth of the Prince of Peace, we are reminded that it is through efforts such as yours and of people like you in our alliances that some semblance of peace is maintained in the world today, so that we might live without conflict and cherish good will to all men.

To those of you who cannot be with your families and friends, I wish to

extend a special Yuletide greeting and good wishes.

I hope that 1964 will be a year of greater prosperity and peace for each and every one of you. A very merry Christmas.

Hon. Lucien Cardin

Associate Minister of National Defence

Peace on earth, good will to all men is as applicable today as it was on that day 2,000 years ago when Jesus, our Saviour, was born. As Christmas approaches, we welcome the opportunity to express this good will towards our fellow men. It is an important part of our Christian tradition.

As Associate Minister of National Defence, it gives me great pleasure to express my sincere appreciation to all members of the Canadian Armed Forces, the Defence Research Board and the Department of National Defence for their devotion to duty throughout 1963. Without such support Canada could not maintain her contribution to the collective defence forces of the Western Alliance.

To those of you who are serving at sea, in remote parts of Canada, with units of our various forces abroad, and away from families and friends at this time of the year, I wish to send a special wish of good cheer.

As the festive season approaches, I hope that all of you will have a very merry Christmas and that you will find a greater measure of peace and happiness through the New Year.

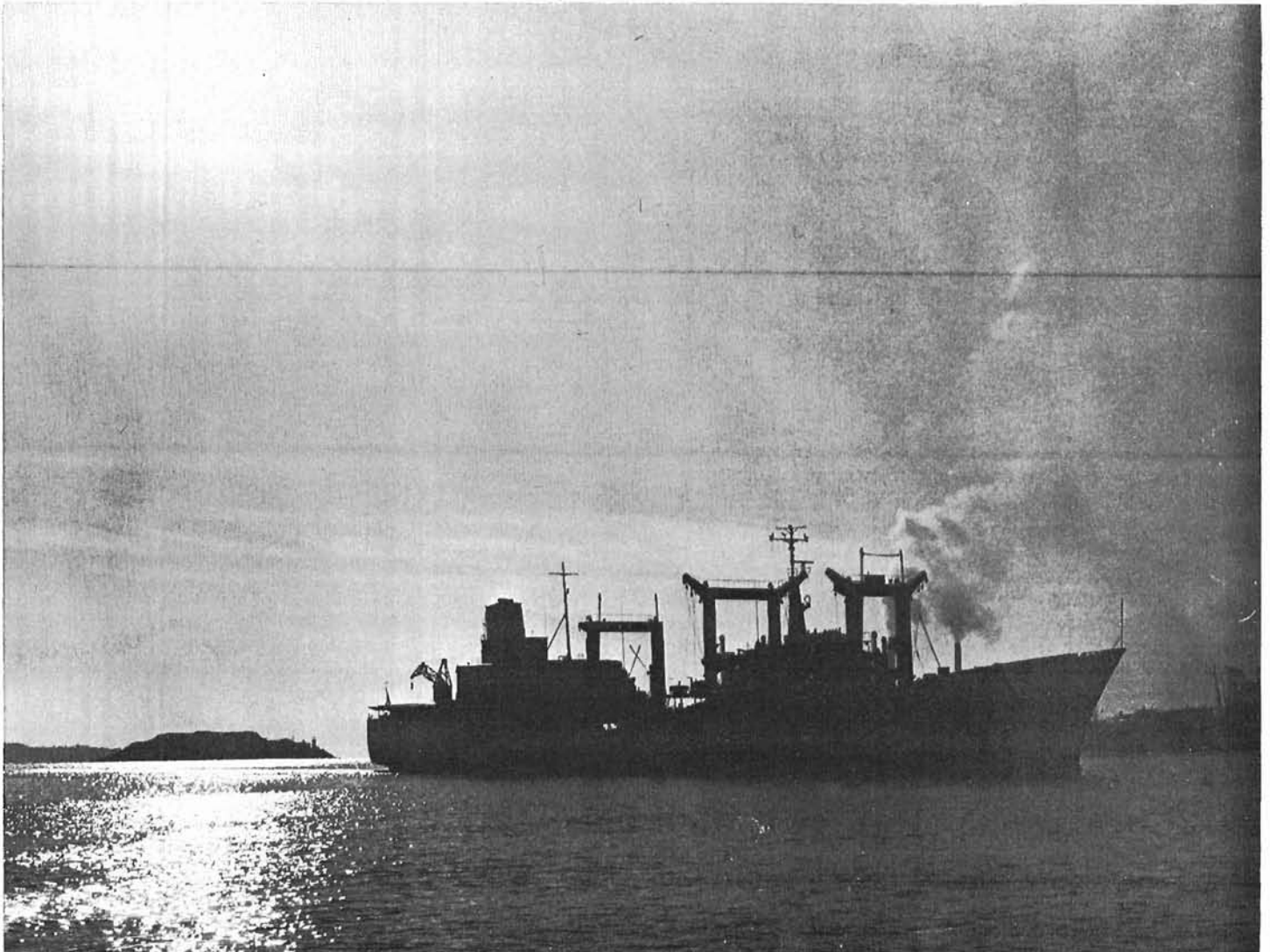

A new silhouette has been added to the East Coast seascape. This "moonlit" scene shows HMCS Provider in Halifax harbour, with George Island in the background. (HS-73622)

You may have read the accompanying story before. It first appeared in the December 1954 issue of *The Crow'snest* and, at the author's request, it was published anonymously. It is reprinted now because of what it says between the lines of the personality and ideals of one of the Royal Canadian Navy's ablest and best-known officers.

The author was among the 118 persons who lost their lives in the crash of a TCA DC-8 jetline near Montreal November 29. He was Cdr. Kenneth E. Grant, 47, Commander Sea Cadets for the RCN since March and before that Commander of the Ninth Canadian Escort Squadron for just over two years.

A native of Vancouver and a graduate of the University of British Columbia, Cdr. Grant was a newspaperman before entering the RCNVR in January 1941 as a sub-lieutenant. He spent much of the war at sea, specializing as an anti-submarine control officer.

Cdr. Grant served as a sea cadet area officer and as Deputy Director of Sea Cadets from 1946 to 1951. He then specialized in damage control, was officer-in-charge of the damage control school in Halifax, went to sea as executive officer of the Algonquin and, from 1957 to 1960, was commandant of the Joint NBCD Warfare School at Camp Borden.

He took command of the frigate squadron, *Cortron 9*, in December 1960, and became Commander Sea Cadets on the staff of the Commanding Officers Naval

Divisions, Hamilton in March 1963. He was on his way back to Hamilton from a sea cadet conference in Halifax when the tragedy occurred.

In his sea cadet appointments and during his three years at Camp Borden, Cdr. Grant met a great many Canadians—youths, private citizens and personnel of the three services. All who met him held him in the highest regard, both personally and as a representative of the RCN. During the time he was in command of *Cortron 9*, the squadron spirit reached an all-time high.

Aside from his other accomplishments, Cdr. Grant was an unusually talented writer and undoubtedly could have done well in this field had he so chosen. Over the years he contributed, sometimes on request but more often voluntarily, numerous articles, book reviews, essays and reports to *The Crow'snest*. At his request, many were printed without identification of the author. That he should have expended so much time and effort of his own volition, and without visible reward or recognition, is, in the opinion of the editors, ample evidence of this officer's deep sense of responsibility and desire to serve.

The editors of *The Crow'snest* feel, along with his countless other friends, a deep personal loss in the death of Ken Grant, and join in extending sympathy to his wife and daughter.

A DOG'S LIFE

"GOING to sea is a dog's life." For centuries this wise warning has been uttered in every language of mankind by every manner of seafarer since the first cave man paddled home from a trial ride on a pointed log. And for just as many centuries young men have ignored the warning and sailed off in search of new worlds beyond the horizon. Why?

First of all, because the veteran seaman usually weakened his argument by staying at sea himself. Whatever he said about life at sea, he made it pretty obvious that he regarded seamen as a much superior breed to the pale tradesmen of the towns who went meekly home to their wives every night at five o'clock.

And, secondly, the old salt, whether he was a Carthaginian trader, an Elizabethan pirate, or a Lunenburg fisherman, was a totally different animal from the landsman—as local magistrates have always known. His beefy complexion, lusty laughter and holiday mood set him clearly apart from the plodding wage-

slaves of the city's pavements. Older citizens might view him with disapproval, but to the younger generations the world-traveller brought a refreshing echo of far lands and high adventure, spiced with suggestions of a more pagan code of conduct than that enforced at home. He rolled off strange, rich-sounding names like Zanzibar, Valparaiso, Timor and Tahiti. Nothing can be more disturbing to a young man faced with a dreary future in tedious

commerce or industry, half a century to be spent between a grim factory and dreary suburb.

And what happens when the youngster goes to sea?

As always, the young man of today gets disillusioned. For centuries the ship, which seemed so lovely in the offing with her towering white canvas and sweeping lines, turned out to be a verminous prison with stinking bilges and unspeakable food. Today's ships, for all their comforts, can become steel prisons filled with endless noise and frustrations, particularly to the new seaman. Most of us would not be surprised to learn that Hell is equipped with long lurching alley-ways, high coamings, watertight doors and steep ladders, all lit by ruby night-lights and scented with the aroma of stale bedding and fresh mal-de-mer. And assuredly Hell must be fitted, by now, with raucous loud-speakers through which His Satanic Majesty makes piercing pipes every few minutes . . . "Souls under punishment to muster in No. 756 Boiler Room . . ."



And this is but another attraction of the sea. It is an ordeal. Not everyone can endure it. It leaves its mark on men's souls. And men prize these scars later as badges of honour which distinguish them from lesser mortals and make them comrades in a secret and unspoken brotherhood. Going to sea is to some extent a male ritual, like serving seven years in the French Foreign Legion, or climbing Mount Everest or sailing alone across the Atlantic. In some primitive and forgotten way, it gives each man a new prestige among his fellows, so that the millionaire industrialist will listen respectfully to the modest tales of a penniless vagrant who has rounded Cape Horn under sail, and perhaps wonder at the end just which of them has really attained "success" in life.

It is a significant fact that the far places of our planet today—the lonely seas, the highest peaks, the deepest jungles—are visited only by poor adventurers or by millionaire sportsmen. The latter, if they have the good fortune to win their leisure at a youthful age, soon turn their backs on the easy middle-class comforts of the magazine advertisements, and look for genuine male satisfactions—big game hunting in Africa or the Rockies, sport fishing among the most dangerous of fish, defying entire oceans in puny yachts under painful hardships, or journeying by some other uncomfortable means to the hidden valleys of Tibet or South America.

WHY DO MEN punish themselves in these ways? The psychologists talk glibly of the "death wish", a force opposite and almost equal at times to the survival instinct. Whether we accept such theories or not, it cannot be denied that it is always possible to get volunteers for the most desperate missions. New York's Hayden Planetarium has many thousands of "reservations" already for the first space-ship which departs for the moon. And who has not been stirred by invitations to serve at Padloping Island, or in submarines, or as a paratrooper or a "frog-man"?

In a small way, service at sea fulfils this urge. Seamen are generally dreamers and romantics. Watch their faces as they steam into the channel of some new, or even familiar port. And a few days later, as they steam gratefully away from the same harbour, and feel the ocean swell lifting the deck beneath them, their faces wear the same cheerful, hopeful expression of men headed at last for the ultimate Paradise. Just

over the horizon there awaits that best-of-possible ports, no matter how disappointing the others have been.

Just as Eve spoiled Eden, however, her daughters repeatedly cast their blight over the seaman's existence. I hasten to add that not all Navy wives do this with malice aforethought, although plenty have tried. In order to screen out these latter saboteurs (or saboteuses?) from the Navy's realm, I am suggesting that our Chaplains should make some slight additions to our marriage vows. Something along these lines:

"Will you, Mabel Blotz, solemnly swear in the presence of this congregation that you are not plotting secretly to reform the character of this honest seaman, Joseph Blow, and that you will not develop a



CDR. KENNETH E. GRANT

nervous condition or other ailment in order to have him request an inland draft or try to persuade him to leave Her Majesty's service in order to go into the rug-cleaning business with your old man?"

The fault is not always Mabel's, of course. Often she marries her gallant tar under the illusion that they will spend the remainder of their days until pension in a rose-covered cottage in a pleasant suburb of Hamilton or Winnipeg. So to keep the accounts straight let's ask for a further statement by the groom:

"Will you, Joseph Blow, solemnly swear that you haven't spun any dips to this woman, Mabel Blotz, about having a chum in Drafting

Depot who is going to stop-draft you in barracks for the rest of your five, or that you intend to stop drawing your tot forever, and are going to have all your tattoos removed?"

NAVY WIVES are, generally speaking, the cream of the crop. But not every pretty young thing can make the grade. It is only fair to warn all candidates that sailors are not rational humans, that they spend a large part of their days on the far side of the world, that they are not good husbands—or even good letter-writers—by Ladies' Home Journal standards, and that no girl in her right mind should ever dream of marrying one.

Any girl that is still agreeable to marriage on such a basis is clearly crazy, too, and should make an excellent Navy wife. Seriously, the sailor and his wife have an excellent chance of a happy marriage. Long ago the prophet Mohammed advised bridegrooms: "Let there be spaces in your togetherness", an Islamic variation on "Absence makes the heart grow fonder". Boredom is considered by some experts to be a major cause of divorce in America. It is rarely a problem in Navy families. Like Mohammed, Naval Headquarters believes in "spaces" in our family lives, and provides them quite generously at times.

"To part is to die a little," says a French proverb.

But the pain of parting is better than the taste of love grown stale. And few landsmen ever know the holiday spirit in a home when the sailor returns with gifts from strange lands for everybody. Each person sees the other for a moment plainly as for the first time, with all their special flaws and charms. Most men stop appreciating their wives after they leave the altar, and never think about them again until the funeral. The seaman gets a fresh awareness of his wife's worth with every home-coming.

And what about the seaman's life in the ship? Is it really as painful as the Ancient Mariners would have us think? Frankly, it is never easy. At its best it might be compared with living interminably in an immigrant train (upper berth) which is travelling too fast over a bumpy road-bed in northern Saskatchewan. The scenery is generally nil. There is no comfort, no silence, no end to the movement and the interruptions. And it certainly is cosy, living with all your possessions in a few cubic feet. There is no escape at five o'clock or even at the weekend. The world shrinks into a few metal yards of deck between

the hard pitching bunk and the cramped cell or windy corner that means duty. For the watchkeepers there is no real day or night but only intervals of feeding and dozing between duties.

In my ship, seamen work twelve and a half hours out of each day, and many seamen in smaller ships work far longer than that. And on a long cruise the food becomes interminably dull, no matter how well refrigerated or prepared. A middle-aged egg or head of lettuce can never compete with the youthful article.

Any seaman who suddenly began to visibly enjoy sea duty would be watched with concern. Let him leap from his bunk some morning with a joyous shout, smile at his messmates across the lurching breakfast table, sing a gay song while shaving, and laugh happily to himself while chipping paint all morning, and he would promptly find himself lashed in a bamboo jumper and headed for RCNH, probably by helicopter.

A GREAT DEAL has been talked about "happy ships". But who ever heard of a "happy boiler factory" or a "happy coal mine"? Ships, like industrial plants, are not intended to generate happiness, but to produce a business-like job in the most economical manner. If the workers happen to feel a dizzy sensation of bliss during the process, they would be wise to keep working quietly until the feeling passes.

The hidden dividends of seafaring come in rare and unsuspected ways. Sometimes in the midst of the worst Atlantic storm your ship suddenly comes warmly alive and wins your affection for the way she frees her decks so gallantly from the assaulting seas and rides over the most terrifying crests unscathed. You see the same grin of pleasure beneath your shipmate's sou'westers in these moments, and you know you are playing on the winning team in a major league game against an opponent who is powerful but short-tempered. But usually the sea's rewards are accompanied by finer weather.

There is that first hour of soft darkness after a sudden tropic sunset, when

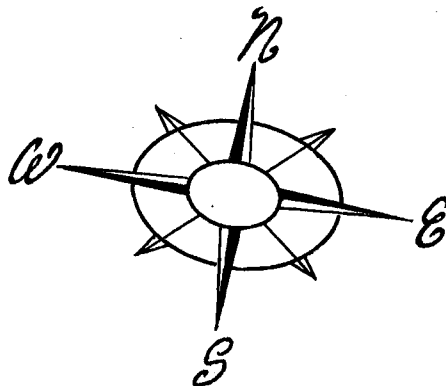

cigarettes glow in a row in the shadow of the awnings and an unseen accordion yearns for the western plains or thumps out a gay melody to the girls of old Quebec. Another reward is the land-fall at dawn, before the lighthouses have ceased their blinking, and while the smell of night jungle rolls seaward in welcome across the creaming reefs.

New islands glistening green in the morning sun, with clouds pluming their volcanic peaks where the Trade Wind surges through . . . and old Spanish ports whose brown battlements have echoed to Drake's broadsides, and whose ancient alleys are still cobbled with Cadiz ballast stones, left by the ancient treasure galleons.

SHORE LEAVE is, of course, the supreme reward for any sailor. Nothing can match that first hour ashore, away from the roaring metal surfaces of the ship, and invading the new life of a foreign land. The sidewalk tables and the grateful shade of palms . . . the glare of the market place where merchants invite you to bargain for baskets or jade or coral souvenirs. The bright clothing and dark eyes and the unfamiliar tongues make every hour an experience. And later the distant white beaches and windy slopes wait to be explored.

If you are one of the growing army of "skin-divers" among the RCN libertymen, you will probably obtain a snorkel mask and flippers and discover an endless new world of colour and wonder along the coral reefs of such islands. Or

you can merely doze in the shade, beyond the call of any boatswain's pipe, and watch the white sails of the flying fishermen creep out towards the blue horizon beyond the reef.

It is not easy to love a modern ship. You can admire them, the way you admire a powerful locomotive or a giant bulldozer. But seen too closely and for too long, any ship blurs into a jungle of unfinished jobs, defective equipment and invading rust.

And then one day you see your ship as you did the first time, across a mile of water. And a miracle occurs. Gone are the rust patches, the weedy boot topping, the slack awning pendant. Instead you see again the swift rake of the stem, the slanted funnel, the whitened cable, the scarlet maple leaf, and the twinkle of brass. It becomes the finest sight in the blue bay. This is one of the brief, sweet moments that rewards the seafarer. I doubt that any other profession can match it.

Approaching home after a good cruise, "channel fever" is always mixed with a concealed note of sadness. Soon the draft notes will pour aboard to dissolve this newly-formed brotherhood that has grown so slowly. And grimy workmen will soil and burn the ship's hard-won beauty. Only the youngest seamen pack their souvenirs merrily in their bags without a thought that one of life's good things is drawing to a close. Older men temper their impatience with thoughts of the unpaid bills, unswept basements and unspanked children that lie in wait for them ashore like serpents in Eden.

One of the Biblical prophets has guaranteed of Heaven that "there shall be no more sea". This is just as well, since it is probably the only "inland draft" most seafarers will see. It would be pleasant to imagine Paradise with a coast like the windward shore of Barbados, with dazzling sand beyond the palms, the warm green lagoons spreading out to the distant reefs. But beyond the reefs would be that wider horizon, and no seaman could look at it for long without wondering if it did not conceal somewhere an even lovelier land.

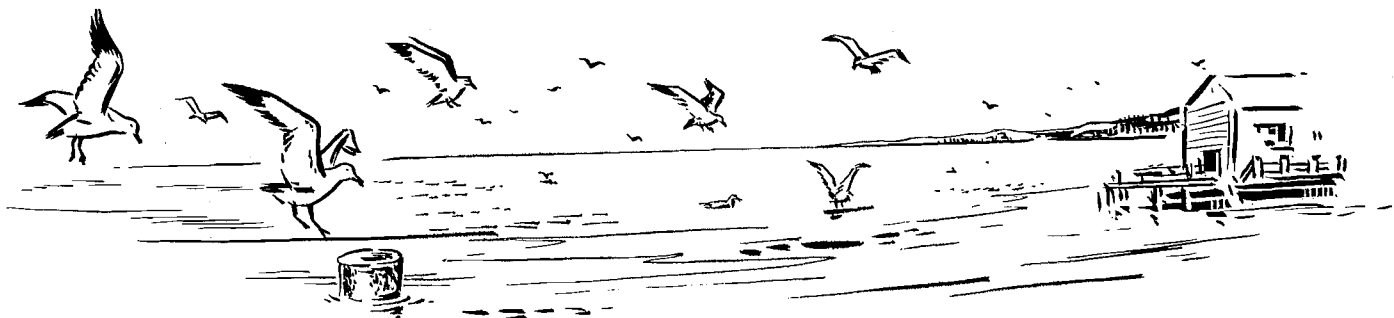

OFFICERS AND MEN

Margaree Gives \$500 to Charity

A cheque for \$500 was presented to the Greater Victoria United Appeal in November by the ships' company of the destroyer escort *Margaree*.

The presentation was made by PO John Pringle on behalf of the welfare committee to Cecil Wesson, chairman of the federal services division of the Community Chest. It brought to \$2,820 the amount of money that officers and men of the ship donated to Greater Victoria charities during 1963.

RCNVR Veteran Senator Killed

A distinguished citizen of Canada and a veteran of service in the RCNVR during the Second World War, Senator Duncan Kenneth MacTavish, OBE, QC, was killed in Toronto on November 15 when the taxi in which he was riding was struck by another car.

An Ottawa lawyer, Senator MacTavish joined the Navy as an acting lieutenant on July 20, 1940, and the following year became Assistant Judge Advocate General. He retired in 1945 in the rank of captain (Special Branch) and as Deputy Judge Advocate General (Navy).

His service was summed up in the citation to the OBE awarded to him on January 1, 1946:

Weddings

Leading Seaman Andrew J. Cleghorn, Naval Radio Station, Bermuda, to Miss Janetta Arnott, of London, England.

Lieutenant Colin MacDonald Curleigh, HMCS *Shearwater*, to Miss Nancy Lee Melanson, of Parrsboro, N.S.

Able Seaman Donald Hugh Coulter, HMCS *Naden*, to Miss Sharon Marie Brash, of Saskatoon.

Able Seaman Garfield T. Fouchard, NRS, Bermuda, to Miss Alice Fougere, of Glace Bay, N.S.

Able Seaman Larry Traies Howe, NRS Bermuda, to Miss June Uwin, East Didsbury, Manchester, England.

Leading Seaman Donald J. Huppe, NRS Bermuda to Miss Kathleen Teresa Mullin, of Londonderry, Ireland.

Sub-Lieutenant Gerhard W. Kautz, HMCS *Fraser*, to Miss Edna-May Dysart, of Victoria, B.C.

Able Seaman Roy Lawrence Smith, HMCS *Fraser*, to Miss Dorothy Anne Ditlevson, of Victoria, B.C.



CAPTAIN D. K. MacTAVISH

"This officer contributed greatly to the Canadian Naval Service by his legal knowledge and its application to naval matters. His appointments as Assistant Judge Advocate General, Deputy Secretary of the Naval Board and, from December 1942 until his retirement in August 1945, as Deputy Judge Advocate General (Navy), were filled with superlative efficiency. His personal qualities, his tact and tolerance have won him the respect and admiration of all with whom he came in contact."

Weapons Officers Hold Symposium

More than 100 weapons officers from all ships squadrons, most establishments and departments on both coasts and Naval Headquarters, and from the Maritime Warfare School and the Sixth Submarine Division, met from September 17 to 19 inclusive for the Second Annual Weapons Symposium at Halifax. HMCS *Stadacona* was host for the occasion.

During the three-day symposium, 29 papers on a wide variety of weapons subjects, both classified and unclassified, were read. Papers covered mine warfare and future developments; Fourth Escort Squadron sonar proficiency competitions; demolition training in the Pacific Command; weapons officers' training in 1965 and many others.

Commodore R. L. Hennessy, Chief of Staff Personnel and Training to the Flag Officer Atlantic Coast, made the opening remarks, followed by Cdr. Ian A. MacPherson, chairman of the symposium. Among the speakers were Cdr. Richard Carle, Assistant Director Fighting Equipment Requirements (AW), Lt. B. J. Brown, Squadron Weapons Officer, Fourth Escort Squadron; Lt.-Cdr. M. P. T. Banyard, RN, Weapons Division, *Stadacona*; Cdr. J. R. Coulter, RCN Director, Joint Maritime Warfare School; Lt. P. A. Boyd, Operations and School; Lt. P. A. Boyd, Operations and E. Connors, Assistant Director Naval Training (Officers) Naval Headquarters, Ottawa.

Following the symposium the second annual Weapons Mess Dinner was held at *Stadacona* wardroom.

Philadelphians Tour RCN Ships

Fifteen thousand persons toured two of the five ships of the Fifth Canadian Escort Squadron that represented Canada at the Canadian Trade Fair in Philadelphia in November.

It was Canada Week at the giant trade fair and the presence of Canadian sailors added greatly to its success. The two ships holding "open house" were the *Columbia* and *Kootenay*. A press reception was held on board the *Columbia* and the resulting press coverage was a tremendous friendship salute to the city.

The *Gatineau*, *Chaudiere* and *Restigouche* were the other ships present.

On Remembrance Day, Rear-Admiral D. W. Piers, chairman of the Canadian Joint Staff, Washington, laid a wreath at the Tomb of the Unknown Soldier and made the address. A 100-man guard, commanded by Lt.-Cdr. Fred Copas marched through the city on the occasion.

Births

To Lieutenant-Commander B. J. Gillespie, Naval Headquarters, and Mrs. Gillespie, a daughter.

To Sub-Lieutenant J. Alain Roy, HMCS *Fraser*, and Mrs. Roy, a daughter.

To Able Seaman David P. Semyroz, HMCS *Fraser*, and Mrs. Semyroz, a daughter.

To Leading Seaman Vernal W. Smith, NRS Bermuda, and Mrs. Smith, a daughter.

Rear-Admiral Piers later spoke at a dinner at the Philadelphia Club and Captain D. L. MacKnight, commander of the Squadron, addressed the United Veterans' Council. Later, Cdr. A. E. Fox, commanding the *Columbia*, and Cdr. D. H. Ryan, commanding the *Kootenay*, both appeared on local television programs.

A squadron hockey team lost a close 7-6 decision to a local club, and a number of men attended the Penn State-Ohio State football games. One man from each ship was a guest at the Ed Sullivan show.

Trade Fair officials were delighted with the impact the Royal Canadian Navy had on Philadelphia and its part in drawing attention to Canada's biggest trade fair yet.

Dr. Arnell New Scientific Adviser

A new Scientific Adviser to the Chief of the Naval Staff was appointed in November in the person of Dr. J. C. Arnell, formerly of Halifax, who had been Scientific Adviser to the Chief of the Air Staff.

Dr. Arnell succeeded Dr. William L. Ford, who has become Chief of Personnel at Defence Research Headquarters in Ottawa.

The former DRB Chief of Personnel, Dr. N. W. Morton, has been lent to the government of Pakistan for a year to



Twin brothers Bob and Larry Murphy (left and right respectively) have won simultaneous promotion to C2TM (X8) at HMCS Carleton, Ottawa. The new chief petty officers joined the Navy together in 1940 through the Saint John, N.B. naval division. Both served on the North Atlantic during the Second World War and were demobilized in 1945, Bob as an ordnance artificer and Larry as a stoker petty officer. Following the war, the Murphys entered the civil service at Ottawa and joined Carleton together in 1952 as petty officers. (O-15297)

assist that country in organizing and establishing a program for a defence research agency.

Dr. Ford's associations with the RCN began in 1948 when he joined the Naval

Research Establishment in Halifax. He later served as Director of Scientific Services for the RCN and was superintendent of the Pacific Naval Laboratory at Esquimalt from 1955 to 1959. In August of the latter year he returned to Ottawa to become Scientific Adviser to the Chief of the Naval Staff.

His successor, Dr. Arnell, is a physical chemist, who has headed the Defence Research Chemical Laboratories and has been Director of Scientific Intelligence. He also spent some time co-ordinating DRB's research into the defensive aspects of atomic, biological and chemical warfare.

Northern Post for Naval Surgeon

Surg. Lt.-Cdr. Michael Joseph Lydon, of Ottawa and Halifax, has been appointed as Chief of Medicine to Fort Churchill Military Hospital near Churchill, Manitoba.

Since 1962, Surg. Lt.-Cdr. Lydon has been attached to the National Defence Medical Centre in Ottawa, completing post graduate training in internal medicine.

Training Officers Meet at Calgary

The first western regional RCNR training conference ever to be held in Calgary was convened at HMCS *Tecumseh*, on November 2. Training offi-



A pow wow took place at the Canadian Trade Fair in Philadelphia on November 13 when four sailors, who were also Indians, surrounded Kahn-Tineta (Green Meadows) Horn, a Mohawk from the Caughnawaga Reserve near Montreal, recently elected Princess Canada by her people. The four seamen were from destroyer escorts of the Fifth Canadian Escort Squadron berthed at the nearby Philadelphia Naval Shipyard. From left to right are Ord. Sea. David Johnston, HMCS *Restigouche*, an Ojibway from Blind River, Ont.; PO Ivan Johnson, HMCS *Kootenay*, an Algonquin from Perth, Ont.; Princess Canada; PO Jack Douglas, HMCS *Columbia*, an Oneida from Brantford, Ont., and Ldg. Sea. Al Belisle, HMCS *Chaudiere*, a Crow from Mattawa, Ont.

cers from all eight naval divisions from Winnipeg to the Pacific Coast were present.

Chairman for the conference was Lt.-Cdr. E. D. Robbins, RCN, since promoted to the rank of commander, who is Command Training Officer for the Commanding Officer Naval Divisions. He was assisted by Lt.-Cdr. R. E. Middleton and Lt.-Cdr. E. J. Hyman, also on COND's staff.

This was the second of three regional conferences covering all the divisions. The participants stated that much benefit was derived from the discussions on mutual problems of reserve training.

Promotion for Commodore Murdoch

Commodore Robert W. Murdoch has been promoted from the rank of Captain in the Royal Canadian Navy and appointed Assistant Chief of Naval Staff (Plans) at Naval Headquarters.

Commodore Murdoch entered the Navy as a cadet in 1936. During the Second World War he served at sea in the Atlantic and Pacific, and qualified as a specialist in naval communications. After the war he became the first RCN officer to be loaned to the USN as a staff communications officer.

Since June 1961 he has served at Naval Headquarters as Director of Naval Intelligence.

Patron Named By Society

Rear-Admiral H. F. Pullen, RCN (Ret), Maritime Governor for the Royal Life Saving Society, announced at the Nova Scotia branch executive committee meeting of the society that His Honour, Lieutenant Governor H. P. Mackeen, was pleased to honour the Nova Scotia branch of the Royal Life Saving Society as patron.

The Nova Scotia branch is now two years old, and is expanding rapidly in its efforts to teach swimmers life saving techniques.

New Appointments For Wren Officers

Lt.-Cdr. Jean Crawford-Smith was appointed in early autumn to the staff of the Assistant Commodore Personnel Atlantic Coast (Manning), at Halifax, as Staff Officer (Wrens) and as Wren New Entry Training Officer.

For the previous two years she had held an exchange appointment with the United States Navy, serving in the Naval Training Centre, Bainbridge, Maryland; the Officer Candidate School, Women, Newport Rhode Island; on special assignments in the Great Lakes Training Centre, Illinois, and in Washington, D.C.

This was the first time an RCN Wren officer had been appointed for duty with the U.S. Navy.

Lt.-Cdr. Crawford-Smith was succeeded in her exchange appointment on September 23 by Lt. Dorothy M. Gower, RCN, who was appointed to the staff of the Naval Training Centre in Bainbridge, Maryland.

DOT Marine Official Retires

On his retirement in November as Director of Marine Operations for the Department of Transport, Captain Eric S. Brand, RCN(Ret), was appointed to the rank of Honorary Commodore of the Canadian Coast Guard.

In announcing the appointment, Hon. George J. McIlraith, Minister of Trans-

port, spoke of Commodore Brand's outstanding contribution to the department since he took over the marine services in 1959.

At a testimonial dinner held by his colleagues of the department, Commodore Brand was presented with a painting from the brush of Cdr. C. A. Law, HMCS *Stadacona*.

Commodore Brand has been succeeded as Director of Marine Operations for the Department of Transport by Rear-Admiral Antony H. G. Storrs, RCN(Ret), former Chief, Ship Division, of the Marine Sciences Branch, Department of Mines and Technical Surveys.

That the Canadian convoy and naval control of shipping systems were set up and ready to operate on the outbreak of

Chief's Rank For Wren

WREN CPO AUDREY WHITE, of HMCS *Carleton*, the Ottawa naval division, recently attained her present rank after 11 years' service in the RCNR.

Joining *Carleton* in 1952 as an ordinary wren in the communications branch, CPO White just topped the 4'10" height requirement of the day—with a quarter of an inch to spare. She has trained on both coasts and has served in *Stadacona*, *Cornwallis*, *Patriot*, *Naden* and *Hochelaga*. She has taken all communications courses available to wrens, the leadership course and the instructional technique course. She has carried out divisional duties with new entry reserve wrens at *Cornwallis* and has instructed at HMCS *Patriot*.

In civilian life, Audrey is a civil servant in the Department of National Defence. Her hobbies include sewing, reading, sailing, and practically all sports except marksmanship ("Can't get my left hand up to the point of balance!").

She particularly values her old service friendships. At a wren reunion at HMCS *Chippawa*, Winnipeg, in 1961 she won a prize for the shortest wren in the service, and she recently flew to Winnipeg, where she attended a ceremony honouring Lt.-Cdr. Fanta Tait, retiring Staff Officer Wrens.

In speaking of the wrens, she immediately grows enthusiastic. "I think we have some of the finest girls in the country," she says. "To begin with, we attract the pick of the crop—then we give them the best all-round training available to young women in Canada today."

On personnel turnover in the wrens, she grows a little rueful. "I'm afraid that's one of our problems," she says. "Our turnover is fast—mainly because of matrimony. I suppose it's a compliment to the type of girl we recruit and what we make of them, but I sometimes wonder if we're training them for service or marriage. In any event," she concludes with a twinkle, "we lose more members that way!"

Chief White's many friends in the service will second the commendation of *Carleton's* commanding officer, Captain J. M. Robertson, when he delivered a "Well done!" before the ships' company at divisions.—C.D.



Captain J. M. Robertson, commanding officer of HMCS *Carleton*, the Ottawa naval division, admires the new chief's buttons earned by Wren CPO Audrey White. (O-5299)

war was largely the result of (then) Cdr. Brand having been lent to the RCN by the Royal Navy in July 1939. On the entry of the United States into the war, he gave that country great assistance with the organization of its convoy system, his help being recognized in 1946 by the award of the U.S. Legion of Merit in the Degree of Commander. Three years earlier he had been awarded the OBE for his services to the Royal Canadian Navy.

After the war and following his retirement from the RCN, Commodore Brand served as Government Controller of Great Lakes shipping during the 1946 Great Lakes strike. His next post was that of executive director of the Canadian Maritime Commission and in 1949 he became the first Director of Marine Operations for the Department of Transport.

His successor, Rear-Admiral Storrs, received his early naval training in the Royal Naval Reserve and he was a revenue ship commander with the Chinese Maritime Customs before joining the RCNR in 1940. He commanded both minesweepers and corvettes and early in 1944 became Senior Officer of the 31st Minesweeping Flotilla of RCN Bangor class ships which had an important part in clearing the channels to the Normandy beachhead. Three nations honoured him for his outstanding services there.

Admiral Storrs transferred to the RCN in 1946, his peace-time appointments including command of the aircraft carrier *Magnificent*. He was appointed to the rank of rear-admiral on taking up the appointment of Commandant of the National Defence College, Kingston, in 1958.

NHQ Post for Captain McPhee

Captain Arthur D. McPhee has been appointed to Naval Headquarters, as Director of Naval Organization and Management. He succeeds Captain Raymond Phillips who is proceeding on retirement leave.

From July 1961 to August 1963 Captain McPhee was Commander First Canadian Escort Squadron, based at Halifax.

Long Service Recognized

S. Thomas Case, clerk of works at Shannon Park naval married quarters, was presented recently with a pin and scroll in recognition of 25 years of service with the Department of National Defence (Navy). The award was made by Captain D. G. Padmore, commanding officer of *Stadacona*.

Mr. Case's association with the RCN has spanned nearly 30 years. He began

his career with the civil service in 1935 at HMC Dockyard as a junior draftsman. He entered the RCNVR in 1940 and served with the Navy until November 1945, when he returned to the civil service. He was promoted to his present position in June 1953.

Mr. Case's father retired from the civil service in January 1949 after 42 years.

Captain Chicken Goes To Pacific Command

Captain Robert H. Chicken, has taken up the appointment of Command Technical Officer to the Flag Officer Pacific Coast.

Captain Chicken graduated from the 1962-63 course at the National Defence College, Kingston, Ont., earlier this year.

Born in England, he served in the Royal Navy during the Second World War, transferring in 1946 to the RCN. He served ashore in Halifax and Ottawa and in the cruiser *Ontario* on the West Coast.

In 1953 Captain Chicken became Principal Naval Ordnance Overseer, Quebec. Two years later he was appointed Superintendent of the Naval Armament Depots, Pacific Coast. He was promoted to captain in mid-1960 on becoming Deputy Director of Naval Ordnance at Naval Headquarters.



The return of HMCS Saskatchewan to Esquimalt on November 29, after an absence of nearly seven months, brought about many happy family reunions. One of many such groups was the family of the ship's captain, Cdr. Mark Mayo, seen here with his wife and four daughters. The children, from left, are: Elizabeth, 10; Cathy, 22 months; Anne, 14 and Susan, 15. (E-7487)

Home from the Sea



Naval Veterans Send Sympathy

A moment of silent tribute to the late President John F. Kennedy marked the opening of the meeting of the Board of Directors of the Canadian Naval Association at Brantford, Ontario, on November 24. A message of sympathy on behalf of the CNA and all ex-Naval personnel in Canada was sent to Mrs. Kennedy.

Two more groups of naval veterans, the Ex-Wrens' Association of Hamilton and District and a recently organized group of veterans in Vancouver, were accepted into the CNA. An inquiry was also received from the Chief and Petty Officers' Association of Winnipeg.

Plans are proceeding well for the 1964 convention, which will be sponsored by the Kitchener-Waterloo Naval Veterans' Association, and it has been decided by the board of directors that the 1965 convention will be held in Guelph, Ontario.

The board also considered the question of Canada's national flag at its November meeting, and decided to support the retention of the Red Ensign, as urged by the Royal Canadian Legion.

Sports chairman Joseph Vecchiola is working out a program designed to en-

courage friendly rivalry and close social ties between the clubs. He recognizes the problems arising from the distance between the various associations, particularly as it affects winter travel, and is trying to find a solution which will be acceptable to everyone.

The annual inter-club sports tournament will be held before the May reunion so that the trophies may be presented as part of the reunion program.

Although some delegates favoured a suggestion of the London NOAC that the Canadian coat of arms should appear on the White Ensign flown by Canadian warships, discussion was postponed for further study.

It was agreed that the Canadian Naval Association should take a larger official part in future naval reunions. The CNA will arrange for a platoon of veterans to supplement the RCN guard at the forthcoming reunion and will hold a reception on the Sunday afternoon.

The directors have again pointed out that representatives of unaffiliated veterans' groups are welcome at CNA meetings as observers.

Copies of an article on the formation and early history of the CNA are available from Sidney R. Piner, 241 Hillcrest Avenue, Hamilton, Ont., on request. This first appeared as an article in the July 1960 issue of *The Crow'snest*.



MTB Reunion Proposed

A reunion of officers and men of the 65th and 54th Canadian Motor Torpedo Boat Flotillas of the Second World War has been proposed, according to Captain J. R. H. Kirkpatrick, RCNR (Ret), of RR No. 1, Preston, Ont.

The current plan is to hold the MTB personnel's get-together in conjunction with the Naval Veterans' Reunion, which will be held at Kitchener, Ontario, in 1964.

Captain Kirkpatrick is making efforts to learn the current addresses of MTB veterans to determine whether enough of them are living sufficiently near Kitchener to make a reunion feasible.

On arrival of HMCS Saskatchewan at HMC Dockyard, Esquimalt, on Nov. 29 Cdr. Mark Mayo's cabin was the scene of an interesting presentation ceremony. In an issue of *Weekend Magazine* last summer, Ed. McNally, former naval war artist, had an illustration showing the Second World War HMCS Saskatchewan in action in a North Atlantic battle. The original painting was presented by Stuart Keate, publisher of the *Victoria Daily Times* and himself a former naval officer, to Cdr. Mayo. The painting measures about four by two feet and will have a place of honour in the destroyer escort's wardroom. (E-74589)

HERE AND THERE IN THE RCN



A plea to the great spirit, Manitou, the owner of all things, to ward off evil spirits, is raised by Jimmy Kitpou, a medicine man of the Micmac tribe. The occasion was an unannounced visit to the Tribal class destroyer Micmac at Dartmouth, N.S., by about a dozen young braves and maidens of the tribe. The Medicine man had been instructed by the chief of the Micmacs to bless the ship. (HS-72665)



A 15-year Long Service and Good Conduct Medal of the Royal Navy was presented on October 3 to CPO George S. Baxter, of HMC Dockyard, Esquimalt, by Commodore H. A. Winnett, Commodore Superintendent Pacific Coast. CPO Baxter, a native of Scotland, has been on loan to the Royal Canadian Navy since December 1961 and at the end of his 15th year in naval service was with Atlantic Command serving in the destroyer escort HMCS Restigouche, whose name is inscribed around the edge of his long service medal. He expects to be on loan to the RCN for another year. (E-73899)



Not only was Rear-Admiral C. J. Dillon, Naval Comptroller, made an honorary fire chief of the fire department of the Naval Supply Centre, Oakland, California, when he visited there this past summer, he was also given a badge and junior-size pumper by Fire Chief Albert Bascou. Rear-Admiral H. C. Haynsworth, Jr., SC, USN, commanding officer of the centre, witnessed the presentation. Admiral Dillon, during his visit, addressed the San Francisco Bay Area Supply Corps Association at Treasure Island. (USN Photo).



"Look, son, this is the wrong way to stop a car," explains Jack Wolfenden, master attendant at HMC Dockyard, Esquimalt, to AB James Crewe, jeep driver in HMCS Margaree, as Safe Driving Week was observed by Pacific Command. Buckled remains of a car placed near the main gate of Dockyard served as a grim reminder of carelessness at wheel. The campaign also included use of the public address system to broadcast safe-driving advice and slogans during heavy pedestrian and car traffic periods by the gate. (E-74616)



For each of the past four years the RCN has been host to the USN Management Course for Senior Foreign Officers during a week's tour of RCN supply facilities. During late October 17 Officers of the course, representing 14 nations, visited HMCS Hochelaga, the Naval Supply Depot, Montreal; College Militaire Royal de Saint-Jean; Canadair, Montreal; Naval Headquarters, Ottawa, the supply and industrial facilities of HMC Dockyard, Halifax; HMCS Cape Scott, mobile repair ship, and HMCS Shearwater, naval air station. The students and accompanying U.S. and Canadian officers were photographed on Parliament Hill, Ottawa. (O-15263)



A pint of blood is a small price for this much attention. PO Yeije Inouye was one of 317 sailors from HMCS Naden who donated blood to a Red Cross Mobile Blood Clinic which paid a one-day mid-November visit to the Naval Barracks at Esquimalt. Beaming approval are Red Cross nurses (from left) Jonnie Cook, Heather Frey, Alice Nasadyke and Catherine Vassallo, all of Vancouver. (E-74403)

AFLOAT AND ASHORE

PACIFIC COMMAND

Second Canadian Escort Squadron

As part of the program to maintain the high efficiency of the RCN's anti-submarine forces, three ships of the Second Escort Squadron sailed for Pearl Harbour via Long Beach in October. On Oct. 1 HMC Ships *Fraser* and *Skeena* sailed from Esquimalt, stopping en route for a brief visit in San Francisco. Rear-Admiral W. M. Landymore, Flag Officer Pacific Coast, was embarked in the *Fraser*. En route, he inspected the ship, then transferred to the *Skeena* to inspect her. After attending a briefing in San Francisco, the admiral returned to Victoria.

HMCS *Margaree* sailed on Oct. 4. A quick, pleasant passage was made to San Francisco, where the *Margaree* rendezvoused with the *Skeena* and *Fraser*. The three ships then proceeded

down the coast and through the Santa Barbara Channel to Long Beach, arriving on Monday, Oct. 7.

The stay in Long Beach was relatively short but the opportunity was seized to visit tourist attractions in the area. Marineland and Disneyland were the two main attractions, with the former drawing the larger number. A number of men took the opportunity to visit Los Angeles and Hollywood. It was not possible to arrange studio tours, but it was still an interesting visit to the fabled city which has provided so much entertainment over the years. Possibly the major disappointment was that the World Series had suddenly ended and the visit was too late to provide a chance to see any baseball.

On the 7th, a reception was held in the Officers' Mess of the Long Beach Naval Base for all the ASW forces proceeding to Hawaii. This gave RCN officers a chance to meet their counterparts

and to discuss informally the forthcoming exercises.

A large number of softball games were played with the host ships and the results were most favourable for the Canadians, who won all but one game.

The fleet sailed on Thursday, October 10, for Pearl Harbour, the *Margaree*, *Fraser* and *Skeena* joining the aircraft carrier USS *Hornet* and four destroyers, the *Keyes*, *Larson*, *Evans* and *Walke*. The ships were on their way to Japan for a tour of duty in WEST-PAC, and the trip was to be the operational readiness evaluation for the *Hornet*.

During the passage, screen exercises were carried out, as well as an AA shoot. This provided the unique experience of firing against a radio-controlled drone. This was quite a challenge, but the *Skeena* came through, downing one with a single burst.



HMCS *Margaree* at Pearl Harbour on November 13. (Official USN Photo)

Rear-Admiral Luker, USN, in the *Hornet* and Captain G. H. Hayes, Commander Second Canadian Escort Squadron, exchanged visits by helicopter, and informally inspected the ships. The use of helicopters to exchange personnel is highly developed in the USN carrier groups. On Sunday, the "Holy Helo Hoppers" went into action and within the limits of a tight schedule, padres were transferred to each ship to conduct divine services.

As the sun rose on October 15 the island of Molokai came into view, to be followed by Koko Head on the island of Oahu. "Goofers" were out in full force during the forenoon as Diamond Head, the landmark of Hawaii, appeared. Most of the ships' companies had been to Pearl Harbour before, but the lure of the islands was still strong. The initial visit was mainly to refuel, as the ships were going out for the first exercise the next day, but not to be denied, there was a great rush ashore at secure.

Sailing on Wednesday, October 16, a convoy protection exercise was carried out. A replenishment group was sailing for Japan and provided the main body to be protected against a number of submarines in the area. For the younger men, it gave an opportunity to see what a convoy really looks like, and to see the problems involved in its protection.

Returning to Pearl Harbour on Friday, the officers were treated to a memorable party in the Ford Island officers' mess. On the way to the island, all had a close look at the impressive memorial erected over the sunken battleship, USS *Arizona*. She was sunk on Dec. 7, 1941, during the great Japanese raid. Containing the bodies of more than 1,000 of her men, the *Arizona* remains as a tribute to all those who gave their lives for their country.

The following night, an interesting situation occurred as a tidal wave alert was broadcast. Most of the ships' companies were ashore, and were amazed at the speed with which the Honolulu police evacuated the Waikiki Beach area. In the protected area of Pearl Harbour, extra lines were rigged, but the whole affair fizzled out with a series of six-inch waves. There was some disappointment among the tourists but, for those who had seen the devastation caused in Hilo by a tidal wave in 1960, there was relief that nothing serious had resulted.

On October 21 the ships sailed for a barrier patrol exercise with an additional four destroyers from the division in Pearl Harbour, and with HMNZ *Taranaki*, anti-submarine frigate.



More than 80 per cent of the ship's company of HMCS La Hullose answered the Red Cross appeal for blood donations while the ship was in refit at Point Edward Naval Base in early October. The deck department came through 100 per cent, which is why Ldg. Sea. O. D. Sampson is shown receiving the "Corpuscle Cup" from Lt.-Cdr. A. L. Lowe, commanding officer. The photo was taken by AB G. S. Young.

Blessed with excellent weather and water conditions, the ships worked around the clock, with submarines in the area and the ominous shadow of an aircraft carrier behind. Combining air and surface capabilities produced good results and gave everyone plenty of experience in controlling aircraft.

After a week-end in harbour, the ships were out again for a hunter-killer exercise, which also went very well. The submarines weren't giving the surface forces any breaks and the whole situation was most realistic. On Nov. 1, at the end of the exercise, a reception was held on the *Fraser's* quarterdeck to entertain the officers of the USN with whom the ships had been working. The week-end was followed by two days of A/S exercises. All these took place in the perfect weather which characterized the whole trip.

A unique feature of the exercises was an exchange program initiated by Captain Hayes and Rear-Admiral Luker. Junior officers and senior men were exchanged each week. The differences in operating procedures were explained, and the view of each other's ships provoked endless discussion and comparison.

Following the exercises, a week was spent alongside in self-maintenance. HMCS *Cape Breton* had arrived to pro-

vide repair facilities. During this period, a number of officers and men took annual leave, bringing their wives to Hawaii for a vacation in the sun. Most took advantage of the facilities available at Fort de Russy on Waikiki Beach during this period. For the remainder, it was a time for Christmas shopping. On Remembrance Day, ceremonial divisions were held on the jetty, followed by a memorial service.

The ships sailed for home on November 13, with nothing but pleasant weather. On Friday, the *Skeena* was detached to take an injured man from the *Cape Breton* to Pearl Harbour. On November 15 the good weather disappeared and the fun began as a gale hit the ships. The storm abated the following day but conditions were still bad and speed of advance was reduced.

On November 21, through the rain and cold, the ships arrived back in Esquimalt to be greeted by a large crowd of dependents. An excellent trip was over.

HMCS Saskatchewan

When the *Saskatchewan* returned to her home port of Esquimalt November 29 for service in the Pacific Command, the ship's company could look back on accomplishments and experiences that would make her first year of service a most memorable one.

In the seven and a half months since she commissioned at Esquimalt, the ship had made two transits of the Panama Canal and four Atlantic crossings, had carried out a special mission and taken part in a major NATO exercise, plus the usual trials and workups. All told, she thus spent 147 days at sea and steamed 25,232 miles.

The *Saskatchewan*, a Mackenzie class destroyer escort, was commissioned at Esquimalt last February 16. A month later she set sail for the Atlantic.

She was at San Juan, Puerto Rico, en route to Halifax, when she was ordered, on the afternoon of May 15, to proceed with all dispatch to waters off Port au Prince, Haiti. The state of affairs in the island republic was such that it seemed prudent to have at hand some means of evacuating Canadian nationals and protecting Canadian government property, should the need arise.

Three hours after receiving her orders the *Saskatchewan* got underway. At 3 p.m. the next day she was on station in international waters off the Haitian capital.

En route, the ship had busily prepared herself for the unexpected assignments. Three landing parties, action boat crews and a shore headquarters group, totalling 97 officers and men, were organized and issued with battle kit and small arms. Arrangements were made to accommodate and feed evacuees.

Off Haiti, the *Saskatchewan* found a U.S. Navy amphibious force and a British frigate engaged in similar duties. Close liaison and friendly relations were quickly established. In the days that followed, the *Saskatchewan* maintained constant patrol, waiting for whatever might develop. Landing party drills, small arms practice and other training activities were conducted. For diversion, there was an exchange of visits with HMS *Caprice*, volleyball on the mortar well cover, shark fishing from the quarterdeck and political radio broadcasts from Port au Prince.

Gradually, the unrest ashore subsided, and on the evening of May 24 the *Saskatchewan* was ordered to proceed to Kingston, Jamaica, for fuel. On May 27 she was formally released from stand-by duty and the next day set sail from Kingston for Halifax.

To what was then the youngest member of the RCN's family of warships went this message from Naval Headquarters:

"Reference your recent operations, you have displayed early in your commission the ability of the RCN to fulfil an important role in readiness to protect Canadian interests. Well done."

The ship carried on to Halifax and joined the First Escort Squadron. She made a quick voyage to England and back and, with the other First Squadron units, visited various Nova Scotia ports. She was off to Britain again in the fall to join NATO exercises in progress north of Scotland. She too weathered the hurricane that beset Canadian and other NATO forces there in October. On the 28th, she parted company and began that long trek back to Pacific waters, and home.

ATLANTIC COMMAND

HMCS Athabaskan

In position 48-34N, 04-32W, five miles NE of Ile de Vierge at 0800 on Oct. 22, 1963, the second HMCS *Athabaskan* lay stopped. As she rolled easily on an oily swell, a short memorial service to the first *Athabaskan* was held and a simple wreath cast upon the sea by the captain, Cdr. P. R. Hinton.

An account of the loss was read to the ships' company, and it was brought to mind that on the day the ship sailed from Portsmouth, Trafalgar Day, Nelson's famous signal was hoisted 108 years earlier in HMS *Victory*.

While many traditions were inherited from the RN, the RCN has an enviable record of its own, to which the two *Athabaskans* in separate wars have contributed.

HMCS Bonaventure

When Lt. Larry Washbrook flew his 12-ton "Tracker" anti-submarine aircraft off the flight deck of HMCS *Bonaventure*, his take off was considered "routine." His landing, however, made him the toast of his squadron.

The arrestor hook of Lt. Washbrook's aircraft caught the wire stretched across the carrier's flight deck, safely halting the bulky, twin-engine plane and marking the 12,000th such arrested landing on board since this ship was commissioned in January 1957.

For Lt. Washbrook, this was the second time he has taken part in a "record" landing. Last fall he was the co-pilot of another Tracker piloted by Lt. Ted Gibbon, now at RCAF Station Moose Jaw, when the 11,000 landing was recorded.

Lt. Washbrook is a pilot of VS 880 naval air squadron now embarked on board the *Bonaventure* during her current European training cruise.

Born in Vancouver on March 16, 1934, Lt. Washbrook entered the RCN as an officer cadet in September 1952 and subsequently took his initial naval

training with the Royal Navy. Following this, he took flying training with the United States Navy, and joined VS 880 Squadron in June 1960.

During the record landing, Lt. Washbrook was flying with Lt.-Cdr. B. J. "Irish" O'Rourke, USN, a U.S. Navy exchange pilot serving with the RCN.

HMCS Shelburne

Lt. Frederick Allan Jones took command of HMCS *Shelburne*, oceanographic station in Nova Scotia, August 16. In two previous appointments he had been executive officer of *Shelburne* and, before taking command, was on exchange with the U.S. Navy, serving on the staff of the Commander Oceanographic Systems Atlantic.

In 1959 he received a suggestion award for devising a circular slide rule which was adopted for use by the Navy and Air Force.

NAVAL DIVISIONS

HMCS Griffon

A Neapolitan sidewalk café decor formed the background and atmosphere for the annual Trafalgar ball at HMCS *Griffon*, the Lakehead naval division, October 18.

A gay colour theme of red, green and mauve, accented with silver, was used in creating a series of café scenes around the bulkhead. Candles of similar hues added touches of colour to the tables. Abstract designs were suspended from the ceiling adding gaiety to the ballroom. Colourful lighting suffused a warm glow over the guests as they danced to the music of Roy Coran's orchestra. The Debonnaires entertained at intermission and during the supper hour.

More than 260 guests were greeted by Cdr. David Binmore, commanding officer and Mrs. Binmore and Lt.-Cdr. Herbert Walton, executive officer, and Mrs. Walton.

HMCS York

Members of HMCS *York*, the Toronto naval division, remembered well on November 10 and 11 those who paid the supreme sacrifice in recent wars.

Not only did members take part in Armistice Day services throughout the city of Toronto but they also conducted a special service within the reserve establishment—the first of its kind.

York personnel served as sentinels and representatives of the Navy in such services as the City Hall commemoration, the Sunrise Service at Prospect Cemetery and St. James Anglican (Run-

nymede) Church service. These services were conducted on Monday, November 11.

The preceding day at York an inter-denominational church service was conducted for the first time in the history of the ship. More than 300 persons, including most of the ship's company, attended.

Chaplain J. Abbott conducted the service and gave the sermon in which he recalled the significant contribution of the Navy in the Second World War and Korea. Commodore J. W. F. Goodchild read the lesson and York's band played the hymns.

The ship's company led the march past following the service. Members of some of the sea cadet and Navy League Cadet Corps also paraded. Commodore Goodchild took the salute.

HMCS Unicorn

Youth is on the side of Lt.-Cdr. Ernest C. Boychuk, new commanding officer of HMCS Unicorn, the Saskatoon naval division, although his naval associations go back for 17 years. He is 29 years of age and, it is suspected, the youngest head of a Canadian naval division.

He joined the Royal Canadian Sea Cadets in 1946, the six years he spent with them being climaxed by the "Class Leader of the Empire" award while he was attending a British Empire training course in England during the summer of 1952.

That same year he received a Navy League university scholarship and joined the University Naval Training Division. In 1955 he was rated the best third-year UNTD cadet in training on the Atlantic Coast and was awarded the Department of National Defence telescope. He was commissioned as sub-lieutenant in the RCNR that same year.

In 1960, Lt.-Cdr. Boychuk was appointed executive officer at Unicorn and this autumn was promoted to his present rank and appointed commanding

officer of the division, succeeding A/Cdr. David M. Keith.

Lt.-Cdr. Boychuk, a Saskatoon lawyer, is married and has three sons.

HMCS Hunter

The White Ensign of one of Her Majesty's Canadian Ships was laid up for safekeeping in St. Paul's Church, Windsor, in October. The ensign belonged to the light cruiser Ontario, paid off several years ago and since broken up in Japan.

The commanding officer of Hunter, Cdr. D. E. Charters, presented the ensign to Chaplain (P) B. A. Silcox, Protestant chaplain of Hunter and rector of St. Paul's. The ship's company of Hunter paraded to the church for the presentation.

Chaplain of the Fleet (P) Harry Ploughman delivered the sermon during the presentation service.

Repeating the successful cruise of last May, the *Porte St. Jean*, gate vessel attached to the Commanding Officer Naval Divisions in Hamilton, spent the last week of October in Windsor. She was brought down and returned over the two weekends involved by crews composed of Hunter personnel.



Cdr. D. E. Charters commanding officer of HMCS Hunter, the Windsor, Ont., naval division, presents a White Ensign from HMCS Ontario to Chaplain B. A. Silcox on the occasion of the laying up of the ensign in St. Paul's Anglican Church, Windsor.

Lake Erie withheld the sort of fall weather for which it is noted, although there was enough of it to produce a few green faces. The Welland Canal was transited in both directions without incident, but it certainly is the hard way to go 24 miles.

GOODBYE TO PATRICIAS

IN THE SIX YEARS since the First Battalion, Princess Patricia's Canadian Light Infantry arrived to take up duties at the Esquimalt Garrison, Work Point Barracks, its members both professionally and socially, have forged a strong bond of friendship with the citizens of Greater Victoria and particularly with the personnel of the Pacific Command of the Royal Canadian Navy.

On the battalion's departure during the autumn for service in Germany, the esteem in which it is held locally was given tangible expression in a number of ceremonies.

Among these was the battalion's salute to the Flag Officer Pacific Coast, Rear-Admiral W. M. Landymore, which took the form of a parade in HMCS Naden on Sunday, October 6. Admiral Landymore took the salute as the battalion marched past and was presented by Lt.-Col. G. G. Brown, officer commanding, with a framed photograph of the Queen's Regimental Colours.

Addressing the parade, Admiral Landymore commented on the close bond which existed between Army and Navy in the area and wished the formation every success in its future undertakings. He in turn presented Col.

Brown with a photograph of the Command's silver drums.

This salute to the Navy was a preliminary to a march through the Township of Esquimalt of both Navy and Army units to a combined drumhead service at Work Point Barracks.

The final military ceremony was undertaken by the Princess Patricias before their departure was a "Beat the Retreat," held in Beacon Hill Park, in which the band of HMCS Naden joined with the First Battalion trumpet band and the band of the Second Battalion PPCLI, stationed in Edmonton. The massed bands totalled some 150 pieces. Reviewing officer was Major General, the Hon. G. R. Pearkes, Lieutenant-Governor of British Columbia.

A number of social functions also were held to mark the battalion's departure, some of which were highlighted by the exchange of badges, of HMCS Naden and the old HMCS Patrician for those of the Patricias.

The personnel of the Pacific Command cherish the memory of the close association with the First Battalion, Princess Patricia's Canadian Light Infantry, and look forward to future occasions on which they may share common interests.—J. W. McD.



Cdr. David M. Keith turns over command of HMCS Unicorn to Lt.-Cdr. Ernest C. Boychuk.

THE U. S. NAVY IN THE PACIFIC

THENCE ROUND CAPE HORN is the title of a handsomely got up book taken from the sailing orders given to Captain John Downes, USS *Macedonian*, at Boston in September, 1818, telling him to take up service in the Pacific. And that's when the US first established a permanent naval force on that great ocean, although the force, until 1923, was often feeble compared to those of other powers.

The author and publisher make much of Downes' evaluation of 1833:

"Everything conspires to render the Pacific of great interest to the people of the United States at the present time. Our future sea fights are as likely to take place here as on the Atlantic Ocean, for here we are acquiring a preponderating commercial interest, and here must be our navy also."

But there were no great sea battles—bits of activity from time to time along the Mexican coastal cities, and elsewhere a few cannon balls to punish villages on islands like Samoa which had been perhaps unduly rough with the motley merchant seamen on their shores.

Forces were pretty well inadequate always and it was fortunate that the

BOOKS for the SAILOR

obsolete American ships never had to fight it out with the British, the French, and at times some of the South American countries, which could boast more and stronger sea power. But having something in the Pacific was very obviously better than having nothing.

However, the prophecy of Downes in 1833 did come true 90 years later with the deployment to the Pacific of the best forces of the USN, a navy now the largest in the world. For in 1923, it was generally realized that Japan was the

prime enemy, which makes the attack on the U.S. installations of Pearl Harbour all the more galling.

Robert Erwin Johnson served from 1941 to 1946 in the "Hooligan Navy" and thereafter went on to gain a PhD. His text is a slender, low-keyed 199 pages and the characters he writes of could stand some fleshing out. The remaining 76 pages will make him the darling of historians, for he has made notes, generous appendices, and an extremely conscientious bibliography of where the stuff can be found. It would appear that he is the first to string the 105 years of the Pacific Squadron together.—H.C.W.

THENCE ROUND CAPE HORN—By Robert Erwin Johnson, published by United States Naval Institute, Annapolis, Maryland; 276 pages; illustrated; \$7.50 U.S.

ALL ABOUT ESCAPE

IF THE READER has a nagging feeling that there is something different in the tone and style of *Escape*, a book dealing with courage and danger, then "vive la difference." The author is a lady.

The back of the book jacket shows her being the first woman to ride the U.S. Navy's ejection-seat test tower in its Air Crew Equipment Laboratory at Philadelphia. Somehow, bundled up in all that clumsy gear and sustaining five gravities, she still manages to look pretty.

Eloise Engle, whose husband is a navy doctor, has done a lot of "guffing up" on her subject, judging from the bibliography and the interviews. Furthermore she took the physiological training course at Andrews Air Force Base, including a "ride" in the altitude chamber in which four males passed out.

She has done a creditable job on her subject and it is pretty obvious that the decorations the U.S. lavishes on its service people were well earned indeed by those who devised and tested the various escape systems. There is drama galore and Mrs. Engle gets it all down, including some episodes from the annals of RAF and RN flying.

In the section on spaceship escapes, she writes: "There is not a single functioning escape system which does not depend upon the parachute. Indeed the 12 Soviet Cosmonaut trainees were

required to make over 40 parachute jumps into varied types of terrain prior to flight qualifications."

So, if there is any reservation about the book, it is that this sentence is the first and last reference to Russian aviation. With the manned bomber fleet the Soviets possess supposedly assigned to clobber a multiplicity of North American targets, it seems their methods of bailing out would be interesting to us all.—H.C.W.

ESCAPE—by Eloise Engle, 256 pages, illustrated and indexed, published in Canada by Longmans, Canada Limited, 137 Bond St., Toronto 2, Ont. Price \$5.95.

SUBMARINE BOOK LIST

LIKE IT or not, the submarine has assumed a dominant position in the navies of today and is unlikely to retreat from that position.

The literature of the submarine cannot compare in volume or richness with that written about the surface ship, but it is growing. Thanks to Jules Verne's wide-ranging imagination and knowledge, *Twenty Thousand Leagues under the Sea*, written nearly a century ago, remains at the top of the list in popularity and books of greater pertinence too often have limited readership.

Presently

"One should eschew words that may be understood in two contradictory senses. Such a word is *presently*. Before the 17th century it meant *now* or *at present*. Then it came to mean *at once* or *immediately*. By the end of the 17th century it had acquired its present meaning of *soon*, *shortly*, or *before long*. But lately a number of persons who evidently prefer long words to short ones have begun to use *presently* in its archaic sense of *now*. In consequence the word has been spoilt, and probably it should no longer be used.

"Some may try to defend it on the ground that the meaning is clear in the context. But they are right only in cases in which the present and future tenses of the verb have different forms, as in the sentence 'I shall sit down presently; you are sitting presently.' But in the sentence 'He is going down town presently' it is impossible to know which is meant, and it may be important, if I want to see him before he goes.

"Therefore let us say *now* and *soon* or *shortly* instead of *presently* and we shall gain precision as well as conciseness."—Gerald M. Clemence, of Yale University Observatory, in a letter to Science, September 20, 1963.

A helping hand has been extended to those who would like to know more about the submarine by Frank J. Anderson in his little volume *Submarines, Submariners, Submarining*, which is described on the title page as "a checklist of submarine books in the English language, principally of the Twentieth Century, arranged by author, title and subject." The description does not do justice to the thoroughness with which he has approached the subject and fails to mention the fairly extensive appendix of foreign books on the subject.

The compiler appears to have excellent credentials. He was a submariner during the Second World War, obtained a college degree in librarianship after the war, was recalled to active submarine duty during the Korean War and for about three years was director of General Dynamics' Submarine Library at Groton, Connecticut. Mr. Anderson is now a college librarian at Salina, Kansas.

He has employed simple methods of coding and cross-reference that make it possible for him to give extensive information about each book in concise form. His listings include British and Canadian publishers as well as American.

This appears to be a most excellent reference work for service libraries as well as for readers who are interested in fact or fantasy about submarines.—C.

SUBMARINES, SUBMARINERS, SUBMARINING, compiled by Frank J. Anderson; published by The Shoe String Press, Inc., Hamden, Connecticut; 140 pages; \$4.

NEW LIGHT ON ARMADA

ANOTHER WRITER has had a go at the Spanish Armada and, on the basis of pure interest, it is a success. Further, he assails some historians strongly enough to goad the reader into delving deeper into this dramatic example of new sea battle tactics and concepts winning resoundingly over the "conventional".

Alexander McKee was doing research on an Armada documentary for the BBC and was lured into writing a book. (Old Aunt's documentaries must be pretty good, for other writers have done the same.)

A navy son, teen-aged aviator, war-time Highlander, postwar Forces writer-producer, and amateur SCUBA diver, McKee brings to bear on his subject a

varied life. He has actually been on board a sunken galleon of the Armada, in underwater archaeology and photography explorations.

Obviously McKee enjoyed writing the book. This makes it a joy to read. It seems a good piece of journalism with telling bits of evidence in quotes from the writings of more than 100 eyewitnesses of the day. Like other writers, he compared this 1588 "Enterprise of England" with the Battle of Britain almost three centuries later.

He eyes the battles as a soldier supposedly would, and claims he finds the tactics ever so much more apparent than some of the "nautical experts". We'll see.

Thank you, Mr. McKee for a readable book, and for prompting further research.—H.C.W.

FROM *MERCILESS INVADER*, by Alexander McKee, published in Canada by the Ryerson Press, 299 Queen St. W., Toronto 2B; illustrated, 291 pages, sources and index; \$6.50.

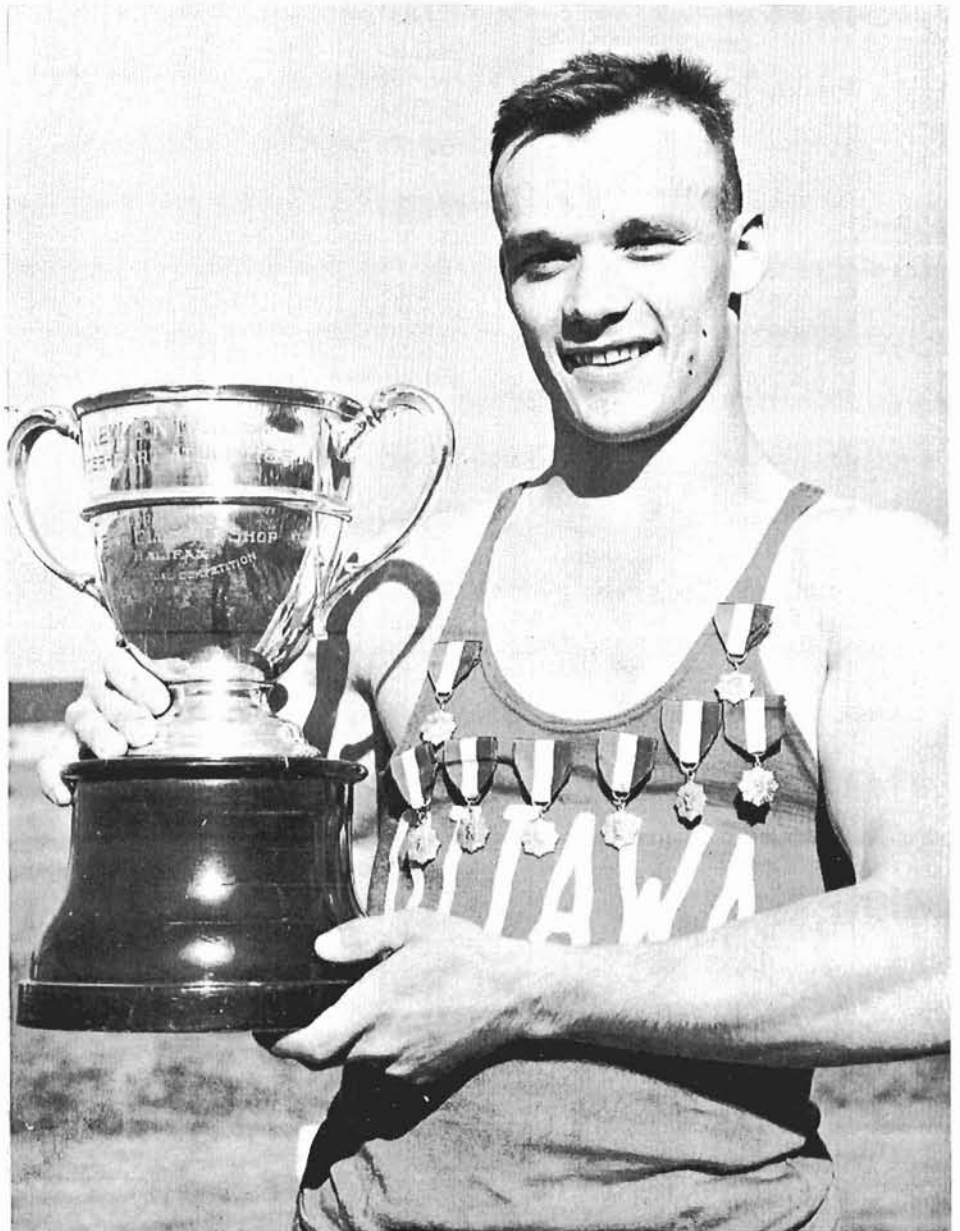

Perhaps inspired by the example of Ord. Sea. Richard Olfert, who won eight first-place medals in a Cornwallis track meet and whose picture appeared on the cover of September *Crowsnest*, Ord. Sea. Richard Sitko stepped out at an autumn track and field meet and also won eight medals—seven firsts and a second. BUT—in approaching the Olfert record, Ord. Sea. Sitko also surpassed it by setting four new marks and tying another. His record-shattering day started when he sprang 20 feet five inches, for a new long-jump record, beat the hop-step-and-jump record by two and a half feet with a mark of 40 feet one inch; ran the 220-yard dash in 24.5 seconds and, by doing the 440-yard dash in 57.5 seconds, chopped three seconds off the previous mark. He also ran the 100-yard dash in 11 seconds, heaved the discus 90 feet, eight inches, and the javelin 131 feet seven inches. His only second place was in the shot-put. (DB-18377)

THE NAVY PLAYS

Skeena Repeats Hockey Win

The *Skeena's* hockey team won the *Cayuga* trophy prize for the Pacific Command championship, for the second consecutive year by defeating a representative team from the Second Minesweeping Squadron 10-4 in the final game.

The game, despite the high score, was one of the finest exhibitions of fast, hard, clean hockey seen in the Command for some years.

The star of the final game was Ord. Sea. J. R. Gregoire, who scored five goals and had two assists. The other *Skeena* goals were scored by Ldg. Sea. D. I. Irvine (2), Ldg. Sea. K. Irvine (2) and Ldg. Sea. G. M. Fisher (1) Ldg.

Sea. D. T. Davidson had five assists to lead in the playmaking department.

A great part of the credit for the *Skeena's* victory goes to PO E. W. Law, the team coach. "Toe" Law is a hard driver and a believer in long skating sessions but the team's condition proved his theories in the final game. *Skeena* scored a total of 29 goals in the series and had only seven slips by PO A. Howe and AB D. D. Funk, the team's goal tenders.

The ship's basketball team made the finals in the Command tournament but was edged out by *Naden*. *Naden's* shooting made the difference in a closely fought game. Members of the *Skeena's* team were Sub-Lt. L. J. Hudon, AB Brian Waddell, AB David Robertson, AB Barry Wilson, AB Danny Gatto, AB

Harvey Bull, Ord. Sea. Barry Roebuck, Ord. Sea. George Farr-Jones, Ord. Sea. Brian Forman and Ord. Sea. Garry Staffen.

Ldg. Sea. Payette Awarded Trophy

Ldg. Sea. G. A. Payette of HMCS *Naden* has won the Lt.-Cdr. Charles McDonald Memorial Trophy, awarded annually to the one who has "through his own achievements or efforts, contributed the most to sports in the Pacific Command throughout the year."

Noted for honourable mention were PO W. B. Lewis, *Naden*, Ldg. Sea. G. A. Anderson, *Cowichan*, AB J. D. Merrifield, *Naden*, AB R. N. Bongard, *Cape Breton*, PO Russell Wilson, *Fraser*, and Lt. C. T. Gunning, *Grilse*.



HMCS *Skeena's* hockey team has won the Pacific Command title for the second year in a row by defeating a team from the Second Canadian Minesweeping Squadron 10-4 in the final. Seated at the left, with the coach, PO E. W. Law, standing at his right hand, is Ord. Sea. J. R. Gregoire, who scored five goals and was credited with two assists. Standing just behind PO Law are Ldg. Sea. D. T. Irvine and Ldg. Sea. K. G. Irvine, each of whom scored twice. Ldg. Sea. G. M. Fisher, seated second from right, got the other tally. Five assists were contributed by Ldg. Sea. D. T. Davidson, seated between the commanding officer, Cdr. M. A. Martin, and executive officer, Lt.-Cdr. J. L. Creech. (E-74865)

The trophy is given in memory of Lt.-Cdr. Charles McDonald, an outstanding athlete and P and RT instructor who died in February, 1949.

Navy Golfer Shatters Par

A husky type (6'2", 235 pounds), Lt.-Cdr. J. P. Croal brought his season play at Rideau Glen Golf Club, about 20 miles south of Ottawa, to a triumphant close.

Whacking the ball with rare authority, Lt.-Cdr. Croal toured twice around the nine-hole par 68 layout and carded a course record of 61. He got four birdies on the way out, scoring 30, and three coming back, for 31, his seven birdies coming on seven different holes during his trip around the course.

Here's what his 61 card looked like:

Par	443	444	434	— 34
Out	433	434	423	— 30
In	442	443	334	— 31

As can be seen, the first and fourth holes were the only ones where he didn't break par on one round or the other.

Scores Settled In Atlantic Command

Autumn's arrival in the Atlantic Command, brought home the facts of life in golf, tri-service softball, Command softball, Fleet softball, Command and Fleet soccer, and in Command outdoor service rifle shooting.

Digby Pines Golf Club was the scene in mid-September of the 1963 Atlantic Command golf championship under the sponsorship of HMCS *Cornwallis*. Entries were registered from five establishments and 11 ships, providing a record field of 121 players.

The team trophy was taken by *Cornwallis* "A", and the low gross was won by Cd. Off. R. Riguse, of *Stadacona*, with cards of 87-81. Team low gross was taken by *Cornwallis* "A" with 700, and the team low net by *Shearwater* "A" with 592.

The tri-service softball championship was won by the Royal Canadian Highland Regiment of Camp Gagetown, which defeated Gagetown Garrison 9-1 in the finals.

HMCS *Shearwater* was host to the Atlantic Command softball championship in which four teams participated. Weather conditions, ship commitments and the time element at play-off made it impossible to decide a winner. The championship was awarded to HMCS *Coverdale* on the basis of runs for and against.

Six teams entered the 1963 Fleet softball championship. The First Escort Squadron team, *Micmac*, won for the second year in a row.

The increasingly popular sport of soccer saw decisions made in fast-moving Fleet and Command championships. The Command soccer championship was booted home by *Stadacona*, which downed *Cornwallis* 2-1. The *Bona-venture* trounced Independent Ships in the Fleet championship.

Bedford Range was the site of the Atlantic Command outdoor service rifle shooting championship, which was sponsored by *Stadacona*. Six teams and one team of individual marksmen competed, with the *Shearwater* team coming out top dog, with a score of 935. Individual winners were high aggregate, PO F. D. Gallant, of *Shearwater* (267), and high individual, PO E. J. Hall of *Stadacona* (41).

Shearwater Rink Opens in October

A new skating rink, the Flyers' Forum, was officially opened at HMCS *Shearwater* on October 25.

Captain G. C. Edwards, commanding officer of the naval air station, presided over the festivities and turned a specially made key which had been frozen in a symbolic block of ice. Cdr. R. V. P. Bowditch, the supply officer, and D.

S. Woods, the contractor, broke the block of ice to obtain the key.

Included in the opening ceremonies was the costume parade by naval personnel and dependents. A fast-moving hockey game was played between last year's inter-mess champions, the petty officers, and an all-star team of officers and leading seamen. The all-stars won 3-2.

The Forum will be available for use by other ships and establishments of the Atlantic Command. Funds for the project were provided by the non-public funds division of the supply organization at *Shearwater*.



A bit of horse play broke the heavy study routine for officer cadets of HMCS *Venture* and Royal Roads as *Venture* devised a unique method of extending an invitation to cadets of the Canadian Services College. Suitably attired and mounted for the occasion were Officer Cadets L. R. Jones (left) and J. P. Belanger, who galloped to Royal Roads to deliver an invitation to compete in the annual Admiral Hibbard Trophy rugby game. A scroll was presented with all due ceremony to Royal Roads Cadet Wing Commander Peter Needra, centre. The game took place on November 16, with Royal Roads defeating *Venture* by a 12-3 score. The kick-off ceremony was performed by Rear-Admiral J. C. Hibbard, RCN (Ret) with the determination that made him a star rigger player in days of yore. Appearances to the contrary, the ball was not filled with cement. (RR-3071; E-74439)

TURNING IDEAS INTO DOLLARS

SOME MOMENTS of thought by uniformed and civilian personnel have earned cash and merchandise awards from the Suggestion Award Board of the Public Service of Canada.

Over the past few months, dozens of awards have been made to personnel who improved on a piece of equipment, thought up a new idea, or suggested doing away with something that was obsolete.

Awards were presented to PO G. S. Tory for suggesting a modification to a shipborne radio remote control system, CPO William Cadwallader for the provision of a portable ladder to facilitate the movement of stores and personnel between decks of St. Laurent class destroyer escorts, PO Michael Shymkovich for an adjustment of naval pay records to speed up income tax credits for personnel with increased personal

exemption, and to CPO R. J. Belliveau for a method of testing the propeller oil system in Tracker aircraft.

Awards were also made to Gordon L. Wambolt, a civilian electrician at HMC Dockyard, Halifax, for a modification to a shipboard announcing system, Walter B. Fader, a technical officer at the Naval Armament Depot, Dartmouth, for radar modifications, and to Fergus T. Heywood, an iron worker at HMC Dockyard, Esquimalt for an improvement in the design of a safety clamp used when fitting anodes to ships' hulls. John T. Clarke, a technical officer at the Naval Armament Depot, Esquimalt, received his award for suggesting a better method for the disposal of used cartridge cases, and William N. Hopkins, an electrician, was recognized for suggesting an additional test reference table for locating defective circuits in naval gunnery system.

An award went to PO J. G. L. Carpentier for proposing the removal of vest pockets from the uniforms worn by Petty Officers Second Class and below. Ldg. Sea. C. W. McShane earned one by suggesting a modification to the armament release equipment in Tracker aircraft. PO Robert W. Foster suggested a new projector screen for naval recruiting visual aid purposes, and PO A. E. Sunderland's offering concerned the design of a tool used for tightening cables in aircraft.

Lt.-Cdr. Edward S. Mitchell devised a tool to facilitate the realigning of rudder bushings in St. Laurent and Restigouche class destroyer escorts.

An electrician at HMC Dockyard, Halifax, B. F. Humphreys, won his award for suggesting a safety repair procedure for naval electrical equipment.

Two awards went to Ldg. Sea. Leo J. R. Babineau for devising a taper pin removal tool for use while servicing Tracker aircraft. His suggestion also qualified for a bonus under the government's Thrift Suggestion Plan. CPO Frank Aquanno won an award for a modification to the lubricant system of Tracker Aircraft, and an award went to CPO Harvey Marshall for a modification to the search radar of Tracker aircraft.

A suggestion concerning a safety brake for use when handling cable won an award for a Seaward defence crane operator at Esquimalt, William C. McQuillan, and a suggestion concerning a

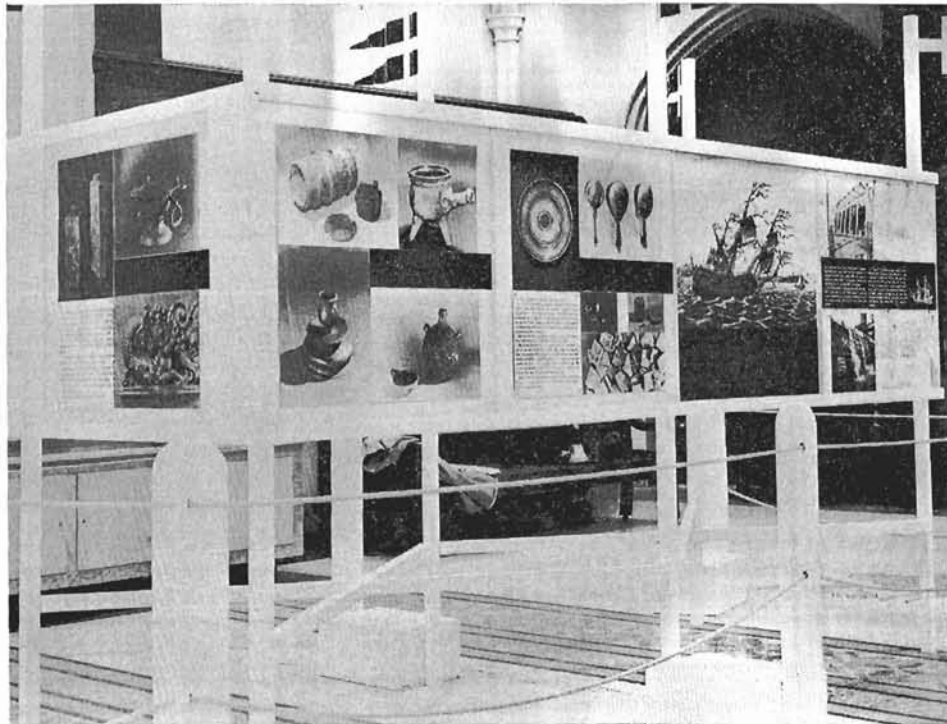
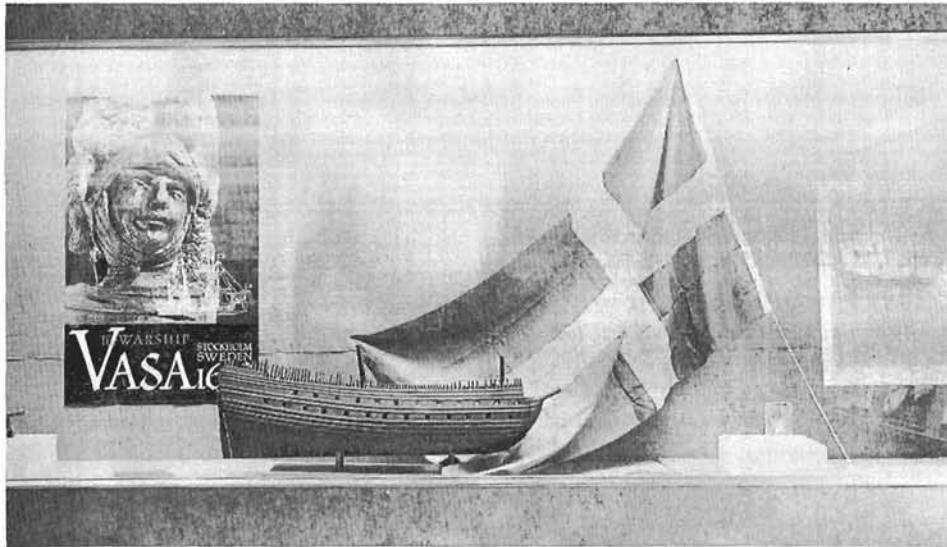

A marine disaster of more than 300 years ago is providing historians of today with intimate and detailed information on life at sea in the 17th century. The proud warship Vasa sank in Stockholm harbour in 1628 on her maiden voyage. Rediscovered in 1961, she has been raised and placed in drydock and innumerable relics have been recovered. Photos, relics and facsimiles telling the story of the Vasa's salvage were on display at the National Gallery in Ottawa in late 1963. (O-15339; O-15337)

safety device for ship's electrical switchboards won one for CPO Frank Stewart Myers.

Mrs. Alice A. MacDonald, a clerk at HMC Dockyard, Halifax, received an award for a suggestion concerning clerical procedures in use in the Civil Service. Substantial savings in transport vehicle life will result from a suggestion put forward by David A. Huck, of HMC Dockyard, Halifax. CPO Andrew G. Reid suggested a protective cap for ships' portable power lines, resulting in a reduction of maintenance costs.

Basil J. Harford, a technician at Rocky Point ammunition depot, suggested a modification to certain torpedo mechanisms to increase efficiency and help avoid damage.

A new hatch-release system for Tracker aircraft which increases the safety factor won an award for Ldg. Sea. Frederick T. Illingworth.

An improvement to destroyer escort boiler maintenance equipment proved profitable for Herbert J. Lane, a boiler-maker at HMC Dockyard, Esquimalt, and a suggestion for the cleaning of ships' fuel tanks won an award for a scaler and cleaner, H. R. Chalmers.

Raynald Verret, a technician at the Naval Supply Depot, Ville LaSalle, Que. suggested a modification to a type of radar equipment, and Norman E. Webb, an electrician at HMC Dockyard, Esquimalt, suggested a modification to mine-sweeping equipment.

LETTER

Sir:

"Naval Lore Corner" No. 120, in the September issue of *The Crow'snest*, reminds us that the distinction between the merchantmen and the man-of-war is not as hard and fast as it sometimes appears. Most famous of the armed merchant cruisers mentioned there is HMS *Jervis Bay*. She sailed on her last voyage from Halifax and had 21 men of Canada's Navy in her ship's company, of whom 13 were killed in action when she and her convoy encountered the German battleship *Admiral Scheer*.

Strange to say, there seems to be no portrait of her except a posthumous painting celebrating her end in battle. It would be most welcome if one of your readers could make available any photograph he might have of HMS *Jervis Bay*.

The text of the "Corner" was marred by a clerical error in the information concerning the fate of HX-84, the convoy that she was escorting at the time.

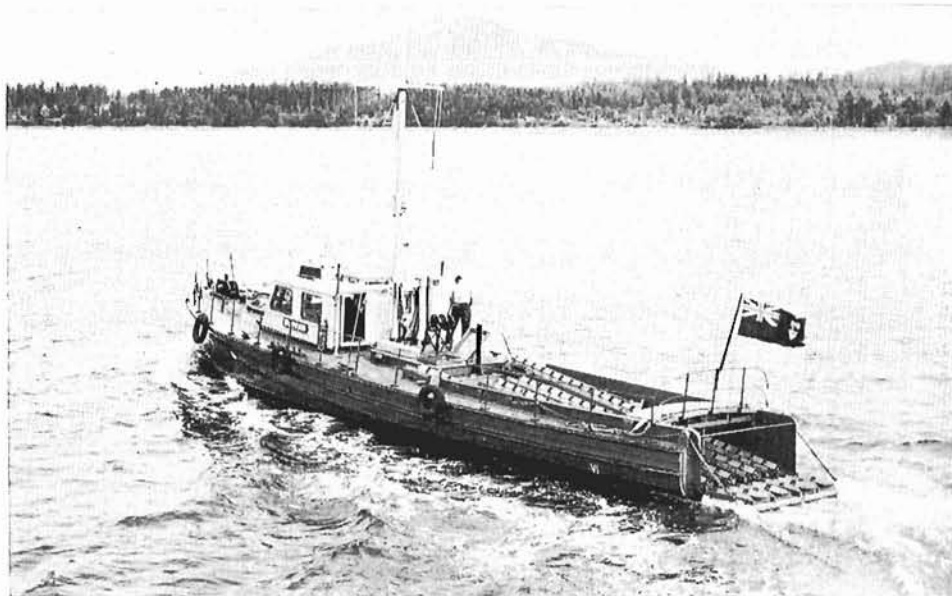

The little CNAV Wildwood, based at Esquimalt, has become a somewhat specialized craft and her appearance could well be a puzzler to anyone not familiar with her task of recovering torpedoes after practice runs. Her roller-equipped ramps simplify the task of taking spent torpedoes from the sea. (E-72172; E-72173)

Not 22, but 32 out of the 37 reached port; five, not 15, went down under the guns of the *Admiral Scheer*. The convoy had originally numbered 38 vessels, but one, the neutral Swedish SS *Vingaland* had straggled before the action, and was sunk by German aircraft in the Western Approaches to the British Isles. Also the British SS *Mopan*, routed independently, passed within sight of HX-84 earlier in the day, fell in with the *Admiral Scheer* and was sunk.

Besides the five ships sunk, the SS *San Demetrio*, laden with gasoline, was

damaged and set on fire, but one boat-load of her crew reboarded her and brought her into a British port.

"Herself she scorned to save" but the *Jervis Bay's* sacrifice was justified because it enabled most of the merchant ships to get away.

Yours sincerely,

E. C. RUSSELL
Naval Historian

Naval Headquarters,
Ottawa, Ontario.

RETIREMENTS

CPO MELVIN ALLEN, CD; C2ER4; joined RCNVR Oct. 31, 1941, transferred to RCN May 1, 1942; served in *Star*, *Nonsuch*, *Naden*, *Stadacona*, *Avalon*, *Dauphin*, *Cornwallis*, *Peregrine*, *Arnprior*, *Scotian*, *New Liskeard*, *Montcalm*, *Haida*, *Portage*, *Huron*, *Bonaventure*, *Shelburne*; retired November 13, 1963.

CPO NORMAN HUNNIFORD, CD; C2ER4; RCNVR Dec. 7, 1936, transferred to RCN July 10, 1940, served in Winnipeg naval division, *Naden*, *San Tomas*, *Empress of Japan*, *Norsal*, *Alberni*, *Stadacona*, *Gananoque*, *Fredericton*, *Peregrine*, *Scotian*, *Niobe*, *Ontario*, *Rockcliffe*, *Chippawa*, *Beacon Hill*, *St. Laurent*, *Athabaskan*, *New Glasgow*, *Royal Roads*, *Crescent*; retired November 9, 1963.

PO STUART HARVEY HUNTER, CD; P2WV2; joined July 15, 1941; served in Calgary naval division, *Naden*, *Stadacona*, *Sackville*, *Cornwallis*, *ML 101*, *Fennel*, *Peregrine*, *Niobe*, *Warrior*, *Magnificent*, *Nootka*, *Haida*, *Cedarwood*, *Athabaskan*, *Discovery*, *Stettler*, *Fortune*, *Fraser*, *Jonquiere*; retired November 18, 1963.

CPO WILLIAM ROBERT LOVIS, CD; CIET4; served in RCNVR April 17, 1942 to Oct. 5, 1945; joined RCN Feb. 15, 1946; served in *Star*, *Nonsuch*, *Naden*, *Givenchy*, *Stadacona*, *Scotian*, *Chaleur*, *Peregrine*, *Lauzon*, *Avalon*, *Montcalm*, *York*, *Quinte*, *Iroquois*, *Magnificent*, *Swansea*, *Huron*, *Algonquin*, *Gatineau*, *Bytown*; retired November 22, 1963.

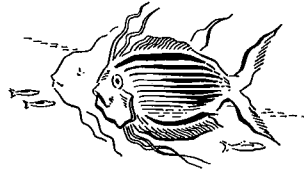

PO WILLIAM ROBERTSON McKAY, P1ER4; joined April 17, 1939; served in *Naden*, *Fraser*, *Assiniboine*, *Stadacona*, *Sackville*, *Columbia*, *Niobe*, *HMS Newfoundland*, *Uganda*, *Ontario*, *Rockcliffe*, *Beacon Hill*, *St. Laurent*, *Algonquin*, *Stettler*, *Crescent*, *Ottawa*; retired November 25, 1963.

CPO EDWARD CHARLES PILLER, CD; C2RP3; served in RCNVR Aug. 13, 1943 to 13 Nov., 1945; joined RCN Jan. 14, 1946; served in *York*, *Donnacona*, *Cornwallis*, *Stadacona*, *Protector*, *Hochelaga II*, *Fort Erie*, *Uganda*, *Scotian*, *Lloyd George*, *Haida*, *RCNAS Dartmouth*, *Swansea*, *Shearwater*, *Magnificent*, *Iroquois*, *Terra Nova*; retired November 12, 1963.

PO JOSEPH FRANCOIS THERIAULT, CD; P1AW3; joined March 7, 1946; served in *Donnacona*, *Naden*, *Stadacona*, *Micmac*, *Iroquois*, *St. Stephen*, *Shearwater*, *Magnificent*, (19CAG), *New Liskeard*, *Cornwallis*, *Portage*, *D'Iberville*, *Restigouche*, *Huron*, *Gloucester*, *Nootka*, retired Nov. 6, 1963.

CPO FREDERICK DONALD WOOD, CD; C2ER4; joined RCNR Nov. 18, 1942, transferred to RCN Aug. 28, 1945, served in *Tecumseh*, *Naden*, *York*, *Stadacona*, *Givenchy*, *Prince Rupert*, *Avalon*, *Peregrine*, *Cayuga*, *Rockcliffe*, *Athabaskan*, *Nonsuch*, *Porte St. Jean*, *James Bay*, *Beacon Hill*, *Assiniboine*, *Cape Breton*; retired Nov. 17, 1963.

OFFICERS RETIRE

CDR GEOFFREY HUNTLEY DAVIDSON, CD; joined RCN August 31, 1934, as a cadet served in *Stadacona*, *HMS Frobisher*, *HMS Royal Sovereign*, *HMS Victory*, *HMS Revenge*, *HMS Excellent*, *HMS Dryad*, *Restigouche*, *Skeena*, *Saguenay*, *Avalon II*, *Prescott*, *Annapolis*, *Niagara*, *RCN College*, *Gatineau*, *Ottawa*, *Scotian*, *Naden*, *Athabaskan*, *Bytown*, *Cayuga*, *Bonaventure*, *Patriot*, *York*; last appointment on staff of Commanding Officer Naval Divisions as Deputy Chief of Staff and Chief Staff Officer Operations and Administration Division; commenced retirement leave November 11, 1963. Retires July 5, 1964.

LT.-CDR. JOHN WILLIAM GRAHAM, CD; joined RCNVR October 22, 1945 as ordinary seaman; transferred to RCN January 14, 1946; promoted to midshipman January 1, 1947; served in *Nonsuch*, *Uganda*, *Niobe*, *HMS Improbable*, *HMS Vengeance*, *Bytown*, *HMS President*, *HMS Agincourt*, *Stadacona*, *Tecumseh*, *Ontario*, *Carleton*, *Naden*, *La Hul-loise*, *Iroquois*, *Niagara*, *Huron*, *Athabaskan*, *Cape Scott*, *Crescent*; last appointment, *Stadacona* for Weapons Division; commenced retirement leave September 17, 1963; retires on January 20, 1964.

LT. (MAd) ROBERT CLARKE JONES, (CD); joined RCNVR January 29, 1941, as sick berth attendant; served in *Stadacona*, *Avalon*, *St. Laurent*, *St. Clair*, *Shelburne*; demobilized January 5, 1946; joined RCN(R) March 3, 1949 as able seaman medical assistant; transferred to RCN September 6, 1949; promoted to acting commissioned officer (MT) November 1, 1952; served in *Stadacona*, *Naden*, *Scotian*, *Cornwallis*, *Bytown*, *Patriot*, *Niagara*, *Shearwater*; last appointment, *Shearwater* as Medical Administrative Officer; commenced retirement leave October 15, 1963; retires January 30, 1964.

LT.-CDR. RAOUL PHILBERT LEMAY, CD; joined RCNVR July 17, 1940, as able seaman; promoted to probationary sub-lieutenant July 19, 1943; served in *Stadacona*, *Ven-*

ture, *Louisburg*, *Avalon*, *Melville*, *Cornwallis*, *Kings*, *Gananoque*, *Montcalm*; demobilized September 15, 1947; joined RCN(R) June 24, 1948, as lieutenant; transferred to RCN February 21, 1951; served in *Montcalm*, *Bytown*, *Cornwallis*, *Stadacona*, *D'Iberville*, *Quebec*, *Cape Breton*, *Naden*; *Cape Scott*; last appointment, *Montcalm* as Recruiting Officer, Quebec City; commenced retirement leave December 21, 1963; retires April 10, 1964.

LT.-CDR. FREDERICK LITTLE, CD; joined RCNVR October 15, 1931, as boy bugler; transferred to RCN May 8, 1933, as ordinary seaman; promoted to acting gunner June 28, 1943; served in *Naden*, *Stadacona*, *Vancouver*, *Fraser*, *HMS Victory*, *HMS Excellent*, *Prince Henry*, *Cornwallis*, *Niobe*, *St. Laurent*, *Niobe*, *Stadacona*, *Ontario*, *Naden*, *Cayuga*, *Quebec*, *Crusader*, *Cape Scott*; last appointment, *Stadacona* on staff of Captain Sea Training as Sea Training Officer, Surface Weapons; commenced retirement leave December 12, 1963; retires on August 14, 1964.

CAPTAIN EDWARD THOMAS GEORGE MADGWICK, DSC, CD; joined RCN on August 31, 1934, as a cadet; served in *Stadacona*, *HMS Frobisher*, *HMS Delhi*, *HMS Devonshire*, *HMS Sussex*, *HMS Victory*, *HMS Excellent*, *HMS Dryad*, *Restigouche*, *Naden*, *Ottawa*, *HMS Excellent*, *Niobe*, *Sambro*, *Iroquois*, *Bytown*, *Stadacona*, *Niobe*, *Haida*, *Huron*, *Cornwallis*, *Micmac*, *Naden*, *Jonquiere*, *Sussexvale*; last appointment, *Niobe*, for course at Imperial Defence College; commenced retirement leave November 4, 1963; retires June 28, 1964.

CDR. EDWARD CRAWFORD MAHON, CD; joined RCNVR November 28, 1942, as a probationary sub-lieutenant (SB); transferred to RCN on June 6, 1946, as instructor lieutenant-commander; served in *York*, *Montreal*, *Prince David*, *Givenchy*, *Star*, *Shelburne*, *St. Hyacinthe*, *Star*, *Bytown*, *Naden*, *Cornwallis*,

Stadacona, *Quebec*; last appointment *Bytown* on staff of Chief of Naval Personnel as Director of Naval Education; commenced retirement leave December 13, 1963; retires May 17, 1964.

COMMODORE MORSON ALEXANDER MEDLAND, CD; joined RCN on September 1, 1930, as a cadet; served in *Stadacona*, *HMS Erebus*, *HMS Revenge*, *HMS Egmont II*, *HMS Royal Oak*, *HMS Victory*, *HMS President*, *HMS Excellent*, *HMS Dryad*, *Saguenay*, *Assiniboine*, *Ottawa*, *St. Croix*, *Cornwallis*, *Bytown*, *Athabaskan*, *Cayuga*, *Naden*, *Niagara*, *Ottawa*, *Bonaventure*; last appointment, *Bytown* as Assistant Chief of Naval Staff (Plans); commenced retirement leave November 25, 1963; retires July 27, 1964.

CAPTAIN RAYMOND PHILLIPS, CD; joined RCN on January 1, 1939, as a cadet; served in *Stadacona*, *HMS Frobisher*, *HMS Belfast*, *HMS Southampton*, *HMS Britannia*, *HMS Nile*, *HMS Liverpool*, *HMS Excellent*, *St. Laurent*, *Niobe*, *Haida*, *Bytown*, *HMS Fulmar*, *HMS Vulture*, *HMS Seahawk*, *HMS Blackcap*, *HMS Triumph*, *Antigonish*, *Naden*, *Cornwallis*, *Fraser*, *Prevost*; last appointment, *Bytown*, on staff of Naval Comptroller as Director of Naval Organization; commenced retirement leave December 9, 1963; retires June 23, 1964.

LT.-CDR. MERLE ERNEST WOODWARD, CD; joined RCN on January 5, 1937, as a stoker second class; promoted to acting warrant engineer on August 1, 1944; served in *Naden*, *Fraser*, *Restigouche*, *HMS Victory*, *Stadacona*, *Ulna*, *Venture*, *Renard*, *Baddeck*, *Givenchy*, *Port Colborne*, *Chebogue*, *Rimouski*, *Niobe*, *Warrior*, *Bytown*, *Cornwallis*, *Crescent*; last appointment, *Stadacona* on staff of Base Superintendent, Sydney, as Manager Engineering Department; commenced retirement leave November 5, 1963; retires June 15, 1964.

Naval Lore Corner

Number 122 "R.C.N. UNDER SAIL"

ALTHOUGH CANADA'S NAVY IS JUST OVER 53 YEARS OLD, SEVERAL OF ITS SHIPS (EXCLUDING SAIL TRAINING VESSELS) HAVE PROVEN THAT THE ART OF SAILING IS NOT YET DEAD... IN WAR OR PEACE...

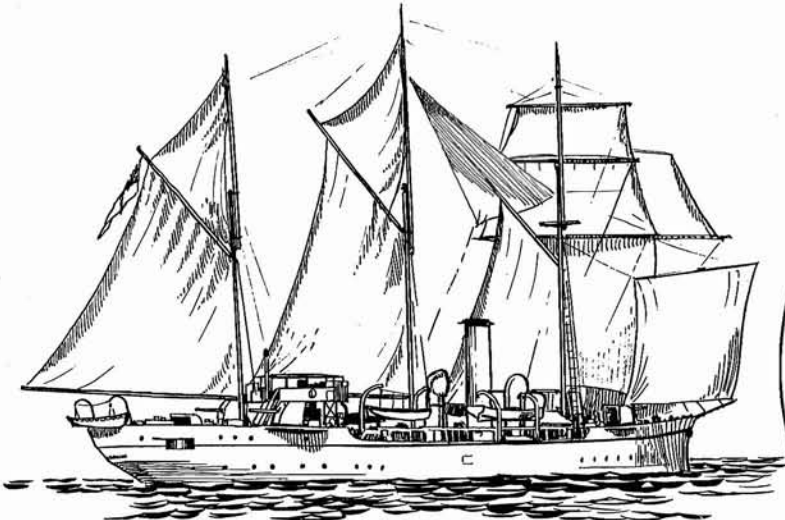

H.M.C.S. SHEARWATER (EX-H.M.S.), A SLOOP OF THE BRITISH PACIFIC STATION STATIONED AT ESQUIMALT WAS COMMISSIONED INTO THE R.C.N. IN SEPTEMBER, 1914 AND WAS EMPLOYED AS A MOTHER SHIP FOR THE SUBMARINES "CC-1" AND "CC-2"

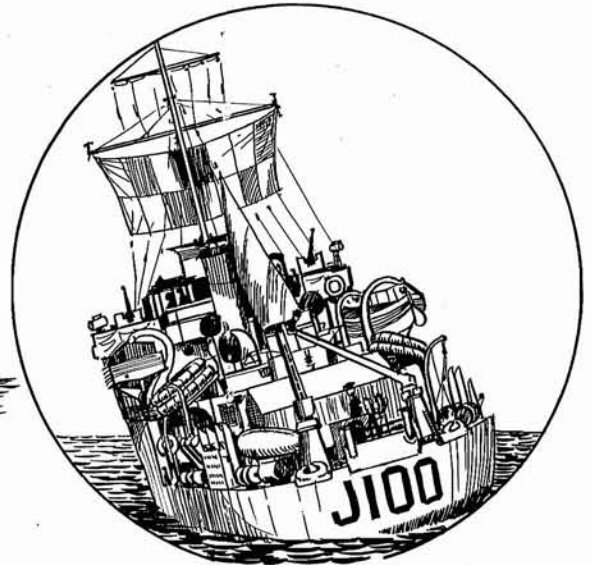

THE MINESWEEPER H.M.C.S. LOCKEPORT SAILED 200 MILES BEFORE BEING TOWED INTO PORT IN JANUARY 1944. A VIOLENT STORM PUT HER MAIN ENGINES OUT OF COMMISSION, AND JURY SAILS WERE MADE OF HAMMOCKS SEWN TOGETHER AND RIGGED AS FORESAIL AND MIZZEN.

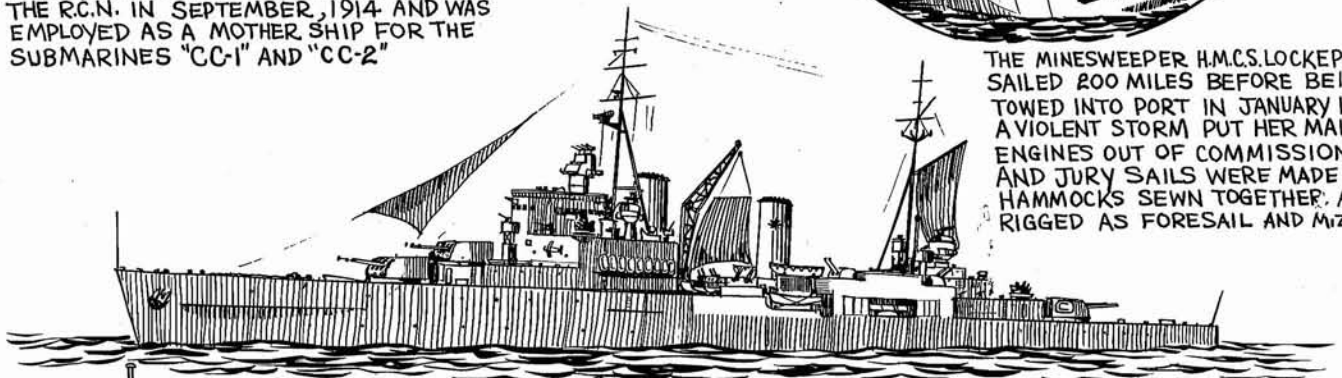

H.M.C.S. UGANDA (LATER QUEBEC) "SAILED" AROUND CAPE HORN ON 20TH MARCH, 1946 TO MARK THE FIRST OCCASION IN WHICH A CANADIAN WARSHIP MADE THE PASSAGE. AWNINGS WERE RIGGED AS MAKESHIFT SAILS...

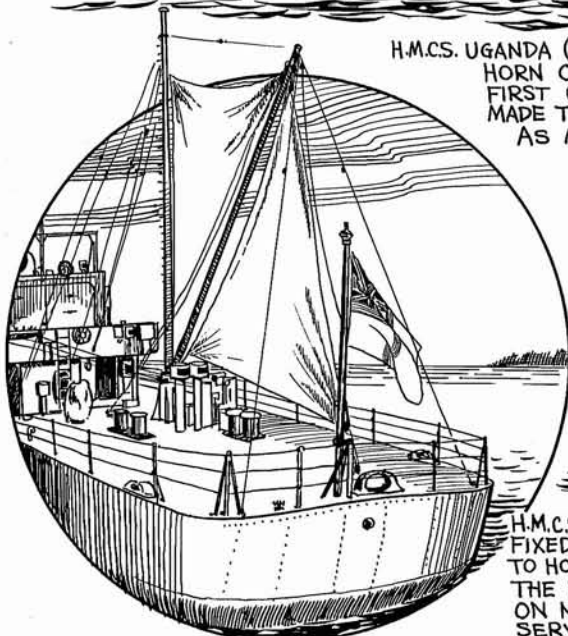

H.M.C.S. ST. STEPHEN (NOW C.C.G.S.) FIXED STAYSAILS (SEE LEFT) TO HOLD THE SHIP'S HEAD INTO THE SEA WHILE EMPLOYED ON NORTH ATLANTIC WEATHER SERVICE...

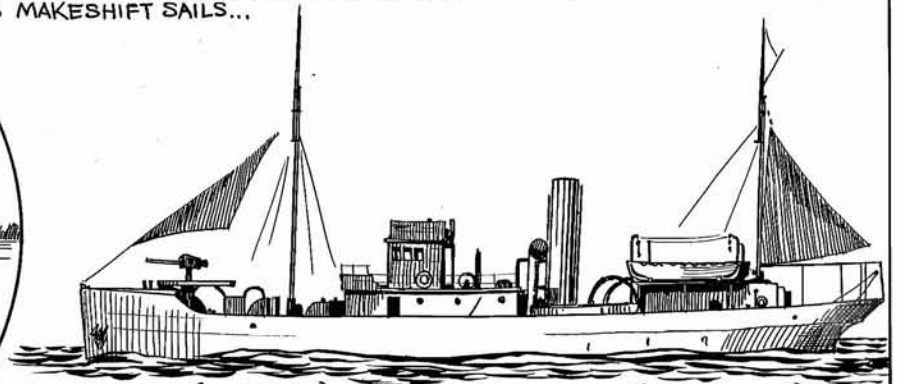

H.M.C.S. ARMENTIERS (MINE SWEEPER) WHILE ON PASSAGE FROM HALIFAX TO ESQUIMALT IN 1919, VIA THE PANAMA CANAL, HOISTED SAIL... PRESUMABLY TO CONSERVE COAL...

Roger Duhamel

QUEEN'S PRINTER—IMPRIMEUR DE LA REINE

YH

If undelivered return to:

The Queen's Printer, Ottawa, Canada

En cas de non-livraison, retourner à:

L'Imprimeur de la Reine, Ottawa, Canada

